



Representative photograph, actual product appearance may vary.

Due to regional agency approval requirements, some products may not be available in your area.

Please contact your regional Honeywell office regarding your product of choice.

SX100GSMT

Pressure Sensors: Measurement Type: Gage; 0 psig to 100 psig Operating Pressure, "SMT" package - No Port

Features

- Low Cost
- Small Size
- Absolute or Gauge Pressures
- High-Impedance Bridge
- Low Power Consumption

Typical Applications

- Pneumatic Controls
- Automotive Diagnostics
- Medical Equipment/ Instrumentation
- Dental Equipment
- Environmental Controls
- Barometric Pressure Measurement
- Altimeters
- Pneumatic Controls
- Battery Powered Equipment

Description

The SX Series surface mount sensors provide the most cost effective method of measuring absolute and gage pressures in a fully packaged sensor. The unique package design allows measurement of both gage and absolute pressure and a ported package option in a true surface mount sensor. Convenient pressure ranges are available to measure gage and absolute pressures for 0 psi to 1 psi to 0 psi to 150 psi.

The SX series of SMT sensors feature the standard SX chip in a ceramic surface mount package. The standard version features a low profile plastic lid to better withstand high temperatures. The optional ported device offers a tube attachment port that is particularly useful in gage applications.

The SX SMT series sensors are designed primarily for use with clean dry gases such as air, nitrogen, and other like gasses. They offer a 4-pin closed bridge configuration for electrical connection with additional pads provided for mechanical support. Pulsed power is recommended to achieve maximum accuracy and conserve battery power in portable applications.



SX100GSMT

Pressure Sensors: Measurement Type: Gage; 0 psig to 100 psig Operating Pressure, "SMT" package - No Port

Product Specifications	
Measurement Type	Gage
Signal Conditioning	Unamplified
Pressure Range	0 psig to 100 psig
Maximum Overpressure	150 psi
Supply Voltage	5.0 Vdc typ., 12.0 Vdc max.
Compensated	No
Output Calibration	No
Response Time	.1 ms typ.
Termination	PCB
Port Style	No Port
Package Style	Standard SMT Package
Typical Sensitivity	0.3 mV/mA/psi ±.05 mV/mA/psi
Zero Pressure Offset	-35.0 mV min., -20.0 mV typ., 0.0 mV max.
Linearity, Hysteresis Error	0.2 typ. 0.5 max. %FS
Repeatability	0.5 typ. % span
Input Resistance	4.1 kOhms typ.
Output Resistance	4.1 kOhms typ.
Operating Temperature Range	-40 °C to 125 °C [-40 °F to 257 °F]
Storage Temperature Range	-55 °C to 125 °C [-67 °F to 257 °F]
Media Compatibility	Clean, dry gases only
UNSPSC Code	411121
UNSPSC Commodity	411121 Transducers
Comment	Lead Temperature Soldering 2 s to 4 s at 250 °C [482 °F]
Availability	Global
Series Name	SX Series



SX100GSMT

Pressure Sensors: Measurement Type: Gage; 0 psig to 100 psig Operating Pressure, "SMT" package - No Port

For Reference Only mm [in]

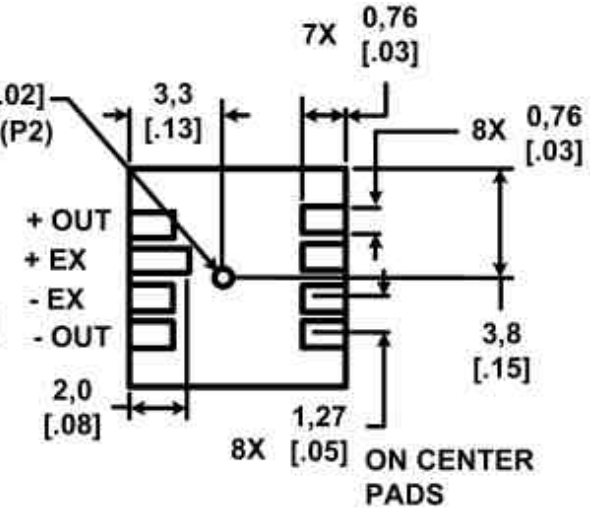
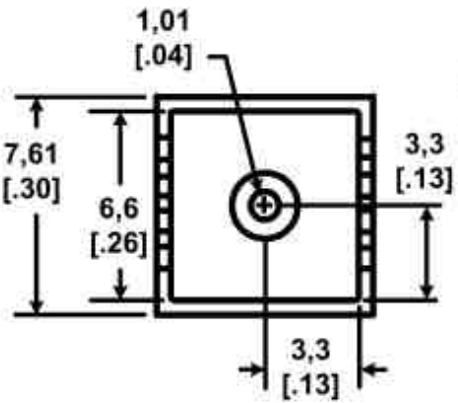

Honeywell

SX100GSMT

Pressure Sensors: Measurement Type: Gage; 0 psig to 100 psig Operating Pressure, "SMT" package - No Port

[Electrical Connections]

Honeywell

SX100GSMT

Pressure Sensors: Measurement Type: Gage; 0 psig to 100 psig Operating Pressure, "SMT" package - No Port

[Equivalent circuit]

Honeywell

SX100GSMT

Pressure Sensors: Measurement Type: Gage; 0 psig to 100 psig Operating Pressure, "SMT" package - No Port

WARNING

PERSONAL INJURY

DO NOT USE these products as safety or emergency stop devices, or in any other application where failure of the product could result in personal injury.

Failure to comply with these instructions could result in death or serious injury.

WARNING

MISUSE OF DOCUMENTATION

- The information presented in this product sheet (or catalog) is for reference only. DO NOT USE this document as product installation information.
- Complete installation, operation and maintenance information is provided in the instructions supplied with each product.

Failure to comply with these instructions could result in death or serious injury.