

## General Description

The MAX17290 evaluation kit (EV kit) is a fully assembled and tested PCB that contains a 16W DC-DC boost converter for battery-operated, harsh environment, front-end preboost applications. The device integrates a low-side FET driver and current-mode, control-loop circuitry for output-voltage regulation, making it ideal for boost or SEPIC converters. The device's integrated driver switches at 400kHz. The MAX17290 can be synchronized with an external clock source within the 100kHz to 1MHz range.

The EV kit operates from a DC supply voltage of 4.5V up to 7.3V. The EV kit can withstand a 16V line transient condition. The EV kit demonstrates the device features, such as dynamic adjustable output voltage, external clock synchronization, two-phase operation configurability, cycle-by-cycle current limit, hiccup mode, and thermal shutdown. The boost converter regulates 8V and can supply a current up to 2A. The EV kit also demonstrates a reference MAX17290 design for battery-operated, harsh environment applications.

## Features

- 4.5V Up to 7.3V Input Voltage Range
- 93% Peak Efficiency at 5V Input
- 8V Up to 2A Output
- Demonstrates External Clock Synchronization
- Spread Spectrum Optimizes EMI Performance
- Demonstrates SUP UVLO
- Demonstrates Cycle-by-Cycle Current Limit and Hiccup Mode
- Thermal-Shutdown Protection
- PGOOD Flag
- Demonstrates Dynamic Adjustable Output
- Demonstrates Single/Two-Phase Operation
- Proven 4-Layer 2oz. PCB Layout and Thermal Design
- Fully Assembled and Tested

## Quick Start

### Required Equipment

- MAX17290 EV kit
- 4.5V to 7.3V, 10A DC power supply
- Digital voltmeter (DVM)
- 2A load

### Output Testing

This EV kit is fully assembled and tested. Follow the steps below to verify board operation. **Caution: Do not turn on the power supply until all connections are completed.**

- 1) Verify that a shunt is installed on pins 1-2 of jumper JU1 (internal 1V reference enabled).
- 2) Connect the power supply's positive terminal to the  $V_{SUP}$  PCB banana jack and the power supply's ground to the PGND PCB banana jack.
- 3) Connect the load across the  $V_{OUT}$  and PGND banana jacks.
- 4) Connect the DVM across  $V_{OUT}$  and PGND.
- 5) Turn on the power supply and set it to 4.5V.
- 6) Measure  $V_{OUT}$  and verify that it is 8V.

[Ordering Information](#) appears at end of data sheet.

## Detailed Description of Hardware

The MAX17290 EV kit is a fully assembled and tested 4-layer PCB that contains a 16W DC-DC boost converter for battery-operated, harsh environment applications, such as front-end, preboost power-supply applications. The EV kit demonstrates the device's features, such as the integrated low-side FET driver and current-mode control-loop circuitry for output-voltage regulation. The device's integrated driver switches at 400kHz and can be synchronized with an external clock source within the 100kHz to 1MHz range.

The EV kit operates from a DC supply voltage of 4.5V up to 7.2V. The EV kit can withstand a 16V line transient, that is limited by input capacitor C4 maximum voltage or U1 specific pin 42V rating, whichever is less. The EV kit demonstrates the device features such as dynamic adjustable output voltage, external clock synchronization, single/two-phase operation configurability, cycle-by-cycle current limit, hiccup mode, and thermal shutdown. The boost converter regulates 8V and can supply a current up to 2A.

### Enable

The EV kit features an enable input that can be used to enable/disable the device and place it in shutdown mode. The EV kit is enabled whenever power is applied to  $V_{SUP}$  and PGND above 4.5V and EN is pulled high.

To enable the EV kit from an external enable signal, remove resistor R10 and apply a logic signal on the EN input and GND pads of the EV kit. The enable (EN) input should not be left unconnected (see [Table 1](#) below).

Refer to the EN pin description in the MAX17290 IC data sheet for additional information. See [Table 1](#) for EN settings.

### Output-Voltage Adjustment

The  $V_{OUT}$  output voltage can be dynamically adjusted by feeding an analog voltage to the REFIN pin and GND pads. The external voltage applied to REFIN is used as the FB reference. Remove the shunt on jumper JU1 to apply an external voltage in the range of 0.750V to 2.000V to REFIN. With the shunt installed on jumper JU1, REFIN is shorted to PVL and an internal 1V FB reference is used for loop regulation. The output voltage can be adjusted in the range of 6.00V to 15.96V. The available output current decreases down to 1A at 15.96V dynamically adjusted output voltage. See [Table 2](#) for jumper JU1 settings.

## External Clock Synchronization

The MAX17290 IC can be synchronized using an external clock applied to the FSET/SYNC pin and GND pads. A falling clock edge on FSET/SYNC turns on the external MOSFET by driving DRV high after a short delay. The MAX17290 can be synchronized with an external clock source within the 100kHz to 1MHz range, and a logic-high voltage range of 2.5V to 5V.

## Two-Phase Configuration

To configure the EV kit for two-phase operation, use two EV kits and follow the instructions below:

### Master EV kit:

- 1) Install a 0603 surface-mount 1k $\Omega$  resistor on the R8 pads.

### Slave EV kit:

- 1) Remove resistors R2 and R1.
- 2) Remove capacitors C2, C3, and resistor R5.
- 3) Install a 0603 surface-mount 0 $\Omega$  resistor on R11 pads.

### Make the following connections:

- 1) Connect the PGND banana jack on the master to the PGND banana jack on the slave.
- 2) Connect the GND banana jack on the master to the GND banana jack on the slave.
- 3) Connect the  $V_{SUP}$  banana jack on the master to the  $V_{SUP}$  banana jack on the slave.
- 4) Connect the  $V_{OUT}$  banana jack on the master to the  $V_{OUT}$  banana jack on the slave.
- 5) Connect the COMP PCB pin on the master to the COMP pin on the slave through a BNC cable.
- 6) Connect the SYNCO pad on the master to the FSET/SYNC pad on the slave.

In two-phase operation, the combined master/slave 8V output is up to 4A (32W).

**Table 1. Enable**

V <sub>SUP</sub> Pullup R10 POSITION	EN PIN	EV KIT OPERATION
Installed*	Connected to V <sub>SUP</sub> through R10	Enabled
Installed	Connected to GND	Disabled
Removed	Connected to an external controller	External controller enabled

\*Default position.

**Table 2. Output-Voltage Adjustment (JU1)**

SHUNT POSITION	REFIN PIN	EV KIT OPERATION
Installed*	Connected to PVL	Internal 1V reference
Not Installed	Open	External voltage reference

\*Default position.

## Component Suppliers

SUPPLIER	WEBSITE
Coilcraft	www.coilcraft.com
Fairchild Semiconductor	www.fairchildsemi.com
Murata Americas	www.murataamericas.com
ON Semiconductor	www.onsemi.com
Panasonic Corp.	www.panasonic.com
Vishay	www.vishay.com

**Note:** Indicate that you are using the MAX17290 when contacting these component suppliers.

## Component Information, PCB Layout, and Schematics

See the following links for component information, PCB layout diagrams, and schematics.

- [MAX17290 EV BOM](#)
- [MAX17290 EV PCB Layout](#)
- [MAX17290 EV Schematic](#)
- [MAX17290 EV Minimal Component Schematic](#)

## Ordering Information

PART	TYPE
MAX17290EVKIT#	EV Kit

#Denotes RoHS compliant.

### Revision History

REVISION NUMBER	REVISION DATE	DESCRIPTION	PAGES CHANGED
0	3/16	Initial release	—

For pricing, delivery, and ordering information, please contact Maxim Direct at 1-888-629-4642, or visit Maxim Integrated's website at [www.maximintegrated.com](http://www.maximintegrated.com).

*Maxim Integrated cannot assume responsibility for use of any circuitry other than circuitry entirely embodied in a Maxim Integrated product. No circuit patent licenses are implied. Maxim Integrated reserves the right to change the circuitry and specifications without notice at any time.*

TITLE: Bill of Materials							
DATE: 03/23/2016							
DESIGN: max17290_evkit_a							
NOTE: DNI--> DO NOT INSTALL ; DNP--> DO NOT PROCURE							
ITEM	REF_DES	DNI/D NP	QTY	MFG PART #	MANU FACTURER	VALUE	DESCRIPTION
1	C1, C7	-	2	GRM32ER61C476KE15	MURATA	47UF	CAPACITOR; SMT (1210); CERAMIC CHIP; 47UF; 16V; TOL=10%; MODEL=GRM SERIES; TG=-55 DEGC TO +85 DEGC; TC=X5R
2	C2	-	1	GRM188R71C683KA01	MURATA	0.068UF	CAPACITOR; SMT (0603); CERAMIC CHIP; 0.068UF; 16V; TOL=10%; TG=-55 DEGC TO +125 DEGC; TC=X7R
3	C3	-	1	GRM39C0G151J50V; GRM1885C1H151JA01	MURATA	150PF	CAPACITOR; SMT (0603); CERAMIC CHIP; 150PF; 50V; TOL=5%; MODEL=; TG=-55 DEGC TO +125 DEGC; TC=COG
4	C4	-	1	EEE-1HA470XP	PANASONIC	47UF	CAPACITOR; SMT (CASE_D8); ALUMINUM- ELECTROLYTIC; 47UF; 50V; TOL=20%; MODEL=S SERIES; TG=-40 DEGC TO +85 DEGC
5	C5, C11	-	2	GRM21BR71H105KA12; CL21B105KBFNNNE	MURATA; SAMSUNG ELECTRONICS	1UF	CAPACITOR; SMT (0805); CERAMIC CHIP; 1UF; 50V; TOL=10%; TG=-55 DEGC TO +125 DEGC; TC=X7R
6	C6	-	1	GRM21BR71E225KA73L	MURATA	2.2UF	CAPACITOR; SMT (0805); CERAMIC CHIP; 2.2UF; 25V; TOL=10%; TG=-55 DEGC TO +125 DEGC; TC=X7R;
7	C8	-	1	C0603C102K5RAC; GRM188R71H102KA01; C0603X7R500-102KNE	KEMET/MURATA/VE NKEL	1000PF	CAPACITOR; SMT; 0603; CERAMIC; 1000pF; 50V; 10%; X7R; -55degC to + 125degC; +/-15% from - 55degC to +125degC, USE 20-1000p-E4 FOR NEW DESIGN
8	C12	-	1	C0603C104K4RAC; GCM188R71C104KA37; C1608X7R1C104K; GRM188R71C104K; C0603X7R160-104KNE	KEMET/MURATA/TDK /VENKEL LTD.	0.1UF	CAPACITOR; SMT (0603); CERAMIC CHIP; 0.1UF; 16V; TOL=10%; TG=-55 DEGC TO +125 DEGC; TC=X7R;
9	COMP	-	1	142-0701-201	JOHNSON COMPONENTS	142-0701-201	CONNECTOR; FEMALE THREADED; THROUGH HOLE; SMA; STRAIGHT THROUGH; 5PINS
10	D1	-	1	PMEG045V150EPD	NXP	PMEG045V15 0EPD	DIODE; SCH; SMT (SOT-1289); PIV=45V; IF=15A
11	JU1	-	1	PEC02SAAN	SULLINS	PEC02SAAN	CONNECTOR; MALE; THROUGH HOLE; BREAKAWAY; STRAIGHT; 2PINS
12	L1	-	1	XAL7070-472ME	COILCRAFT	4.7UH	INDUCTOR; SMT; SHIELDED; 4.7UH; TOL=+/-20%; 13.6A

13	N1	-	1	FDS5670	FAIRCHILD SEMICONDUCTOR	FDS5670	TRAN; 60V N-CHANNEL POWERTRENCH MOSFET; NCH; NSOIC8; PD-(2.5W); I-(10A); V-(60V)
14	R1	-	1	ERJ-3EKF9092	PANASONIC	90.9K	RESISTOR; 0603; 90.9K OHM; 1%; 100PPM; 0.1W; THICK FILM
15	R2	-	1	CRCW060313K0FK; ERJ-3EKF1302V	VISHAY DALE/PANASONIC	13K	RESISTOR, 0603, 13KOHMS, 1%, 100PPM, 0.1W, THICK FILM
16	R3	-	1	ERJ-L12KF22M	PANASONIC	0.022	RESISTOR; 1812; 0.022 OHM; 1%; 300PPM; 0.5W; THICK FILM
17	R4	-	1	CRCW06031001FK; ERJ-3EKF1001V	VISHAY DALE; PANASONIC	1K	RESISTOR; 0603; 1K; 1%; 100PPM; 0.10W; THICK FILM
18	R5	-	1	RT0603FRE076K81L	YAGEO PHICOMP	6.81K	RESISTOR; 0603; 6.81K OHM; 1%; 50PPM; 0.1W ; THIN FILM
19	R6, R10	-	2	CRCW06031003FK; ERJ-3EKF1003	VISHAY DALE/PANASONIC	100K	RESISTOR; 0603; 100K; 1%; 100PPM; 0.10W; THICK FILM
20	R7	-	1	RC1608F6812	SAMSUNG ELECTRONICS	68.1K	RESISTOR; 0603; 68.1K OHM; 1%; 100PPM; 0.1W; THICK FILM
21	R9	-	1	CRCW06030000ZS; MCR03EZPJ000; ERJ-3GEY0R00	VISHAY DALE/ROHM/PANASONIC	0	RESISTOR; 0603; 0 OHM; 0%; JUMPER; 0.10W; THICK FILM
22	TP_PGND, TP_VOUT, TP_VSUP, TP2_PGND	-	4	108-0740-001	EMERSON NETWORK POWER	108-0740-001	CONNECTOR; MALE; PANELMOUNT; BANANA JACK; STRAIGHT; 1PIN
23	TP_GND	-	1	5001	KEYSTONE	N/A	TEST POINT; PIN DIA=0.1IN; TOTAL LENGTH=0.3IN; BOARD HOLE=0.04IN; BLACK; PHOSPHOR BRONZE WIRE SILVER PLATE FINISH;
24	U1	-	1	MAX17290ETCF	MAXIM	MAX17290ETCF	EVKIT PART-IC; MAX17290; PACKAGE OUTLINE: 21-0136; PACKAGE CODE: T1233-4; TQFN12-EP
25	C9, C10	DNP	0	N/A	N/A	OPEN	PACKAGE OUTLINE 0603 NON-POLAR CAPACITOR
26	C13	DNP	0	N/A	N/A	OPEN	PACKAGE OUTLINE 1210 NON-POLAR CAPACITOR
27	EN, GND, PVL, PGND, VOUT, VSUP, PGOOD, REFIN, SYNCO, PAD_GND, PAD_PGND, FSET/SYNC	DNP	0	MAXIMPAD	N/A	MAXIMPAD	EVK KIT PARTS; MAXIM PAD; NO WIRE TO BE SOLDERED ON THE MAXIMPAD
28	R8, R11-R13	DNP	0	N/A	N/A	OPEN	PACKAGE OUTLINE 0603 RESISTOR
29	PCB	-	1	MAX17290	MAXIM	PCB	PCB Board:MAX17290 EVALUATION KIT
TOTAL			31				

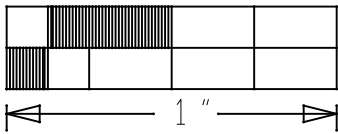
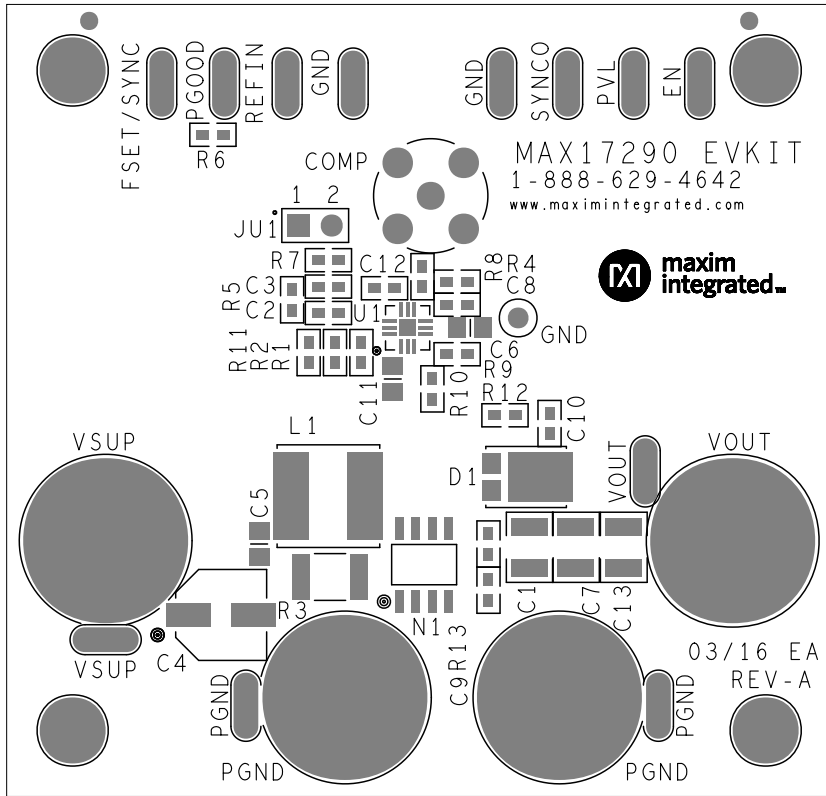

### Top Silkscreen

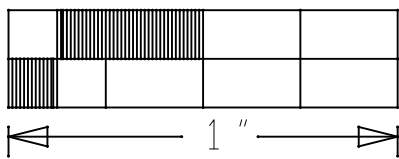
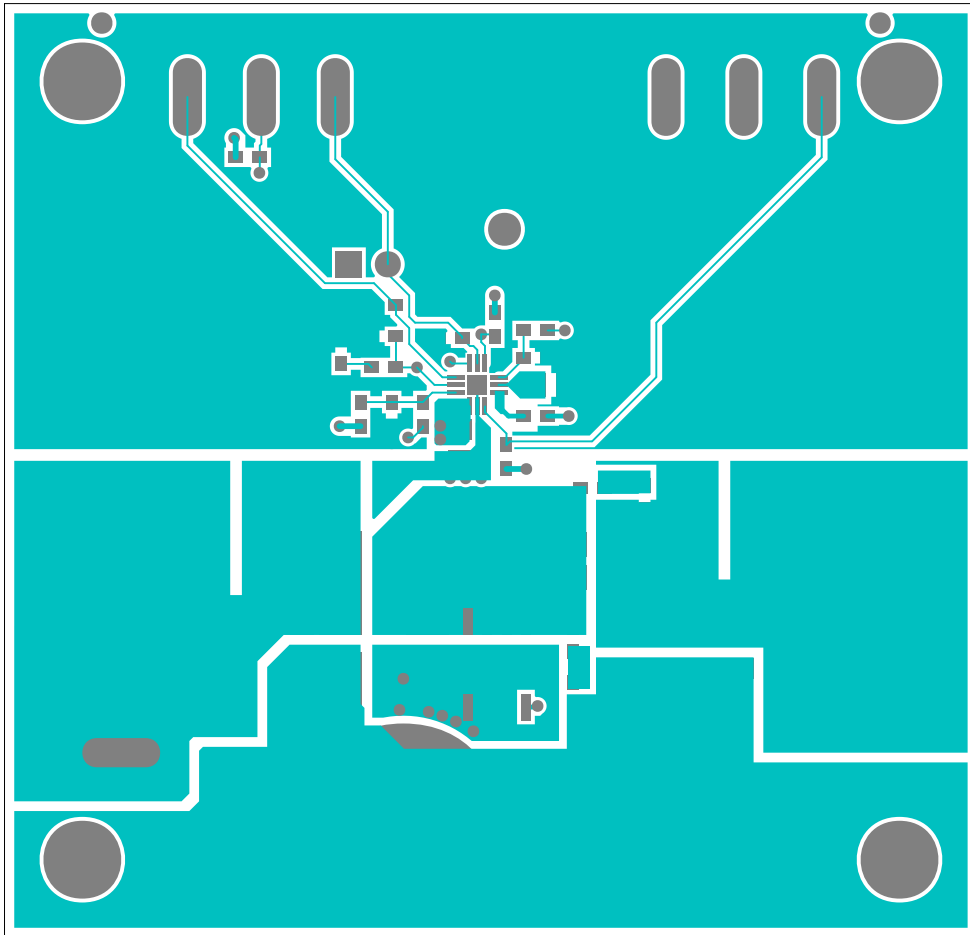

**TOP**



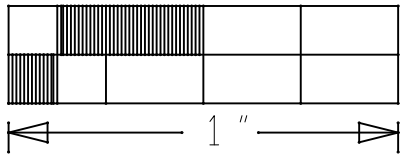
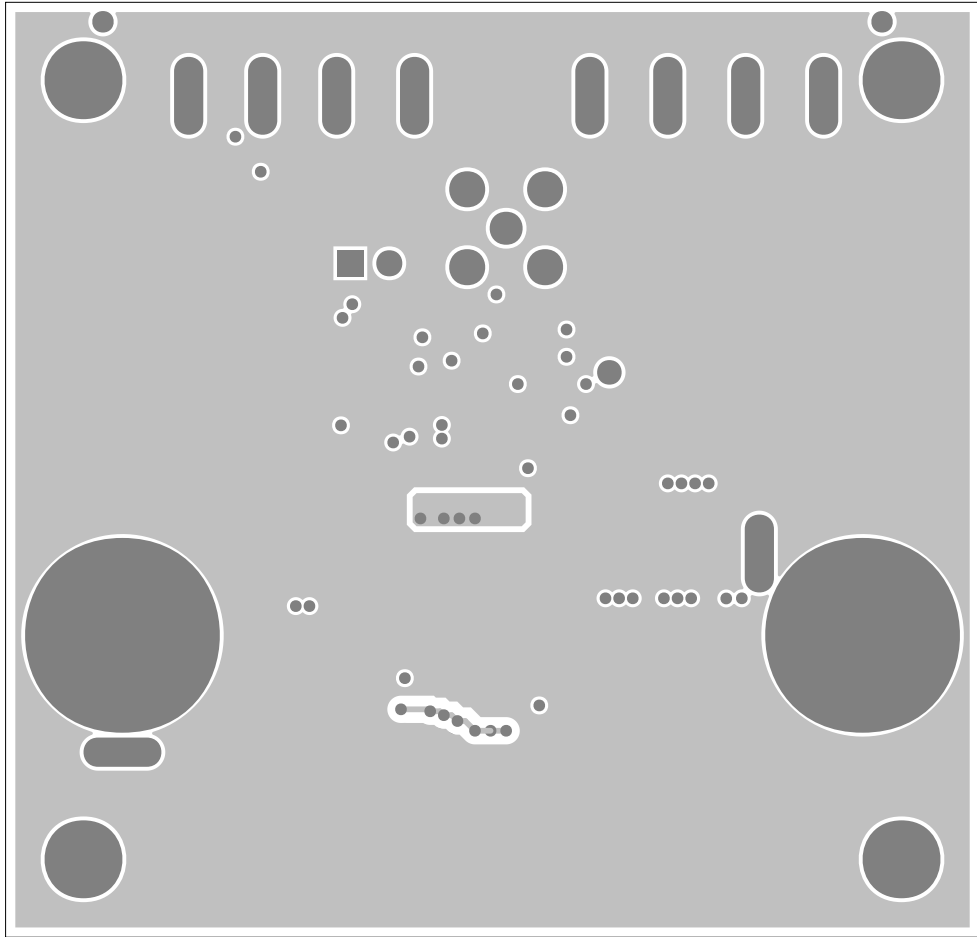

**Internal 2**

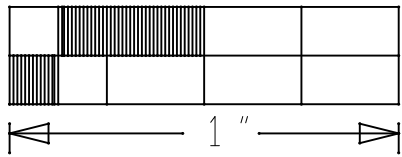
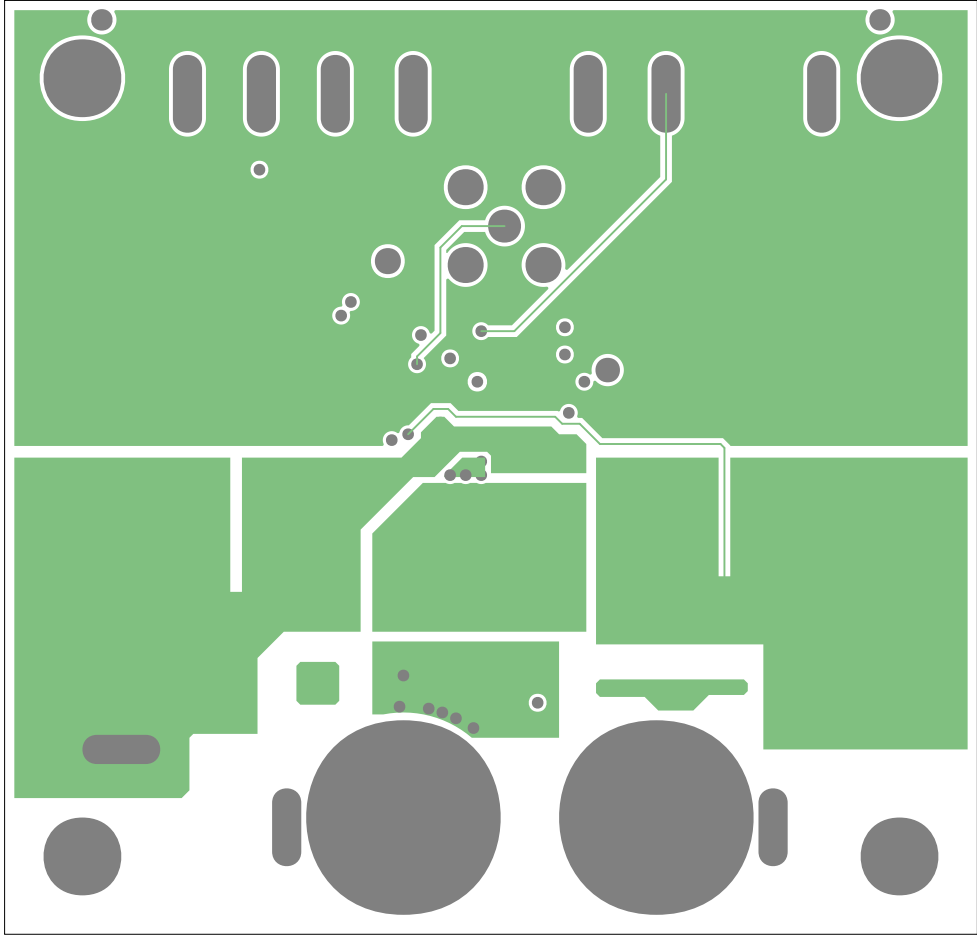

**Internal 3**

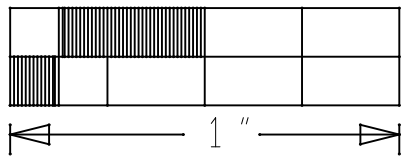
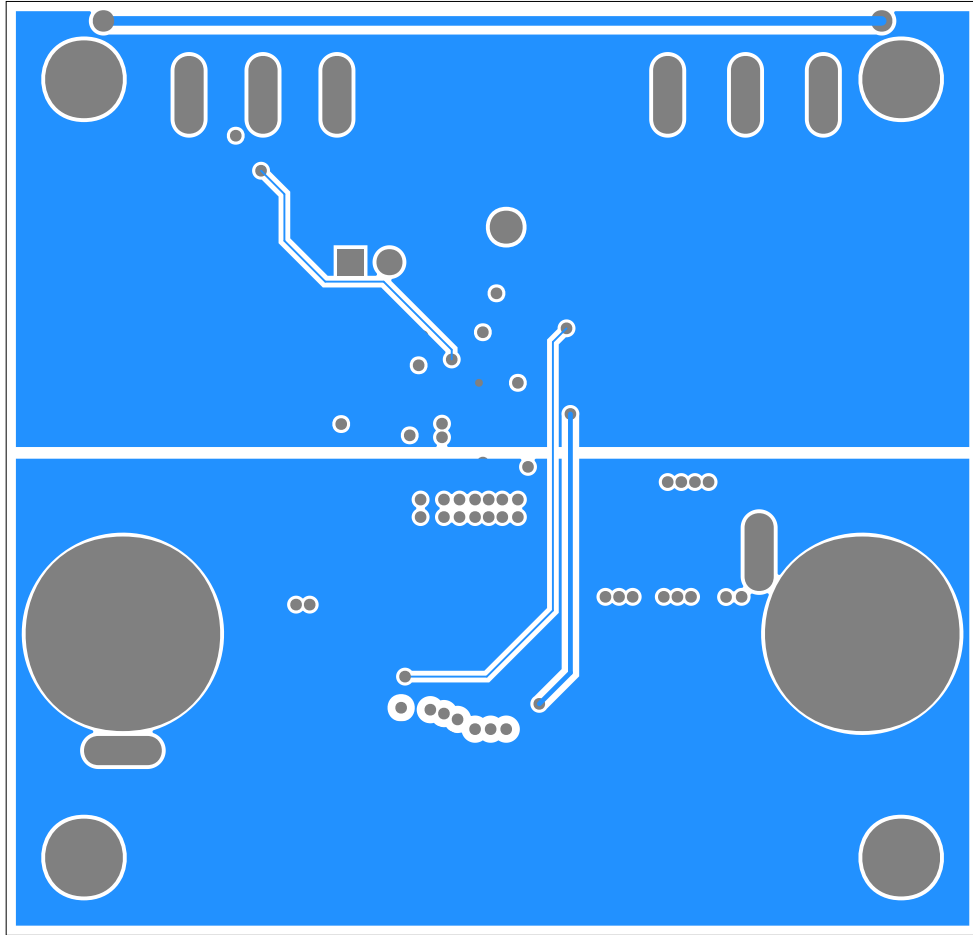

**Bottom**



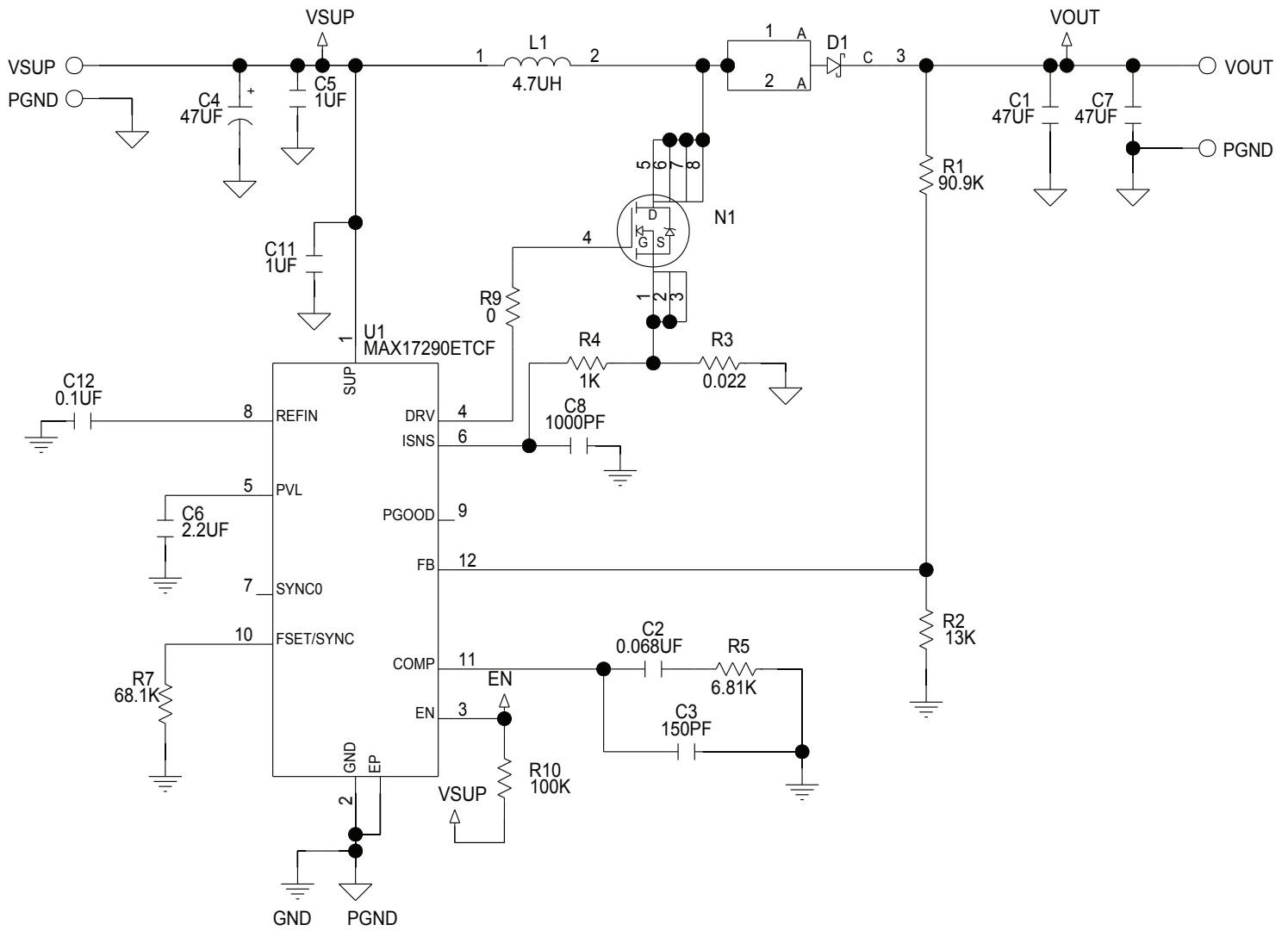

**Minimal Component Schematic**