

KEMET, SSHB21H, Commercial Grade, 0.0112 H

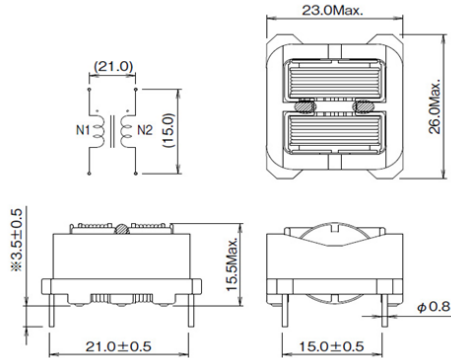

Dimensions	
L	26mm MAX
T	23mm MAX
H	15.5mm MAX
S	15mm +/-0.5mm
S1	21mm NOM
LL	3.5mm +/-0.5mm
F	0.8mm NOM

Packaging Specifications	
Weight:	14 g
Packaging:	Bulk
Packaging Quantity:	360

General Information	
Series:	SSHB21H
Style:	Through-Hole Choke
Description:	Common Mode Filter, SS Coils, SSHB21H, High Impedance Type
RoHS:	Yes
Miscellaneous:	Temperature Rise Maximum: 65 K
Notes:	Marking: R18 Lot No.

Specifications	
Inductance:	11.2 mH (10 kHz)
Temperature Range:	-25/+120C
Rated Temperature:	120C
Current:	1.8 Amps
Voltage AC:	250 VAC
Withstanding Voltage:	2400 VDC
Insulation Resistance:	100 MOhms