



## Technical Data Sheet

### 0.56" Single Digit SMD Displays

#### ELSS-512SYGWA/S530-E2

#### Features

- Packaged in tape and reel for SMT manufacturing.
- Design flexibility(common cathode or anode).
- Categorized for luminous intensity.
- The thickness is thinner than traditional display.
- Pb free.
- The product itself will remain within RoHS compliant version.

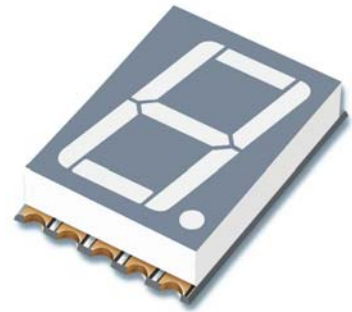

#### Descriptions

- The SMD type is much smaller than traditional type components, thus enabling smaller board size, higher packing density, reduced storage space and finally smaller equipment to be obtained.

#### Applications

- Suitable for indoor use.
- Audio system.
- Set top box.
- Game machine.
- Channel indicator of TV.

#### Device Selection Guide

Chip		Face Color
Material	Emitted Color	
AlGaInP	Brilliant Yellow Green	Gray

**Package Dimensions**

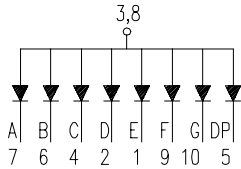
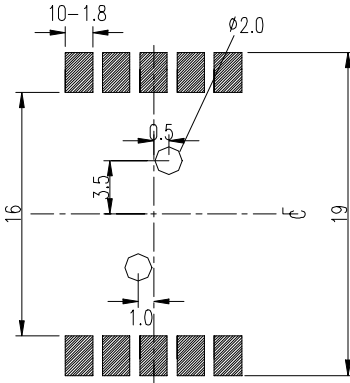
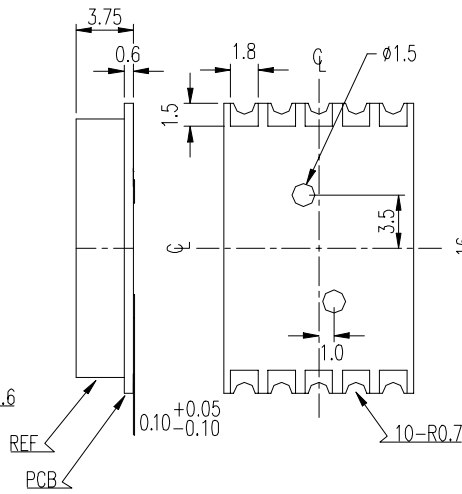
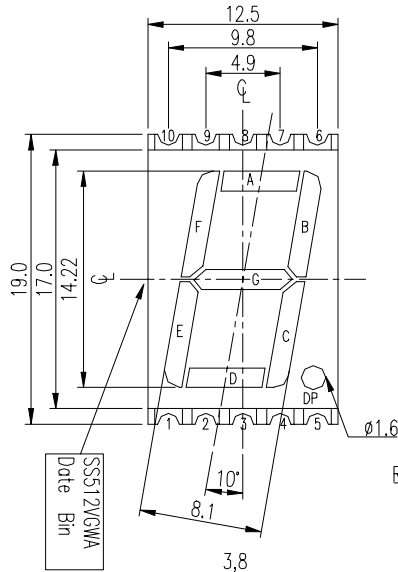

INTERNAL CONNECTION DIAGRM

- 1 CATHODE E
- 2 CATHODE D
- 3 COMMON ANODE
- 4 CATHODE C
- 5 CATHODE DP
- 6 CATHODE B
- 7 CATHODE A
- 8 COMMON ANODE
- 9 CATHODE F
- 10 CATHODE G

**Notes:**

- All dimensions are in millimeters, tolerance is 0.25mm unless otherwise noted.
- Above specification may be changed without notice. Supplier will reserve authority on material change for above specification.

**Absolute Maximum Ratings (Ta=25°C)**

Parameter	Symbol	Rating	Units
Forward Current	I <sub>F</sub>	25	mA
Pulse Forward Current <sup>*1</sup>	I <sub>FP</sub>	60	mA
Operating Temperature	T <sub>opr</sub>	-40 ~ +85	°C
Storage Temperature	T <sub>stg</sub>	-40 ~ +85	°C
Reflow Temperature	T <sub>ref</sub>	260	°C
Electrostatic Discharge	ESD	2000	V
Power Dissipation	P <sub>d</sub>	60	mW
Reverse Voltage	V <sub>R</sub>	5	V

**Notes:** \*1:I<sub>FP</sub> Conditions--Pulse Width ≤ 10msec and Duty ≤ 1/10.

\*2:Reflow time ≤ 5 seconds.

**Electro-Optical Characteristics (Ta=25°C)**

Parameter		Symbol	Min.	Typ.	Max.	Units	Condition
Forward Voltage		$V_F$	--	2.0	2.4	V	$I_F=20mA$
Reverse Current		$I_R$	--	--	10	$\mu A$	$V_R=5V$
Luminous Intensity	Per segment	$I_V$	4.0	10.8	--	mcd	$I_F=10mA$
	Per decimal point		1.4	3.9	--		
Peak Wavelength		$\lambda_p$	--	575	--	nm	$I_F=20mA$
Dominant Wavelength		$\lambda_d$	--	573	--	nm	$I_F=20mA$
Spectrum Radiation Bandwidth		$\Delta \lambda$	--	20	--	nm	$I_F=20mA$

**Chromaticity Coordinates Specifications for Bin Grading (Unit: mcd)**

Rank	Min.	Max.	Rank	Min.	Max.
N	4.0	6.4	T	21.0	34.0
P	5.6	8.9	U	30.0	48.0
Q	7.8	12.5	V	42.0	67.0
R	11.0	17.6	W	59.0	94.0
S	15.0	24.0	---	---	---

**Typical Electro-Optical Characteristics Curves**

(SYG)

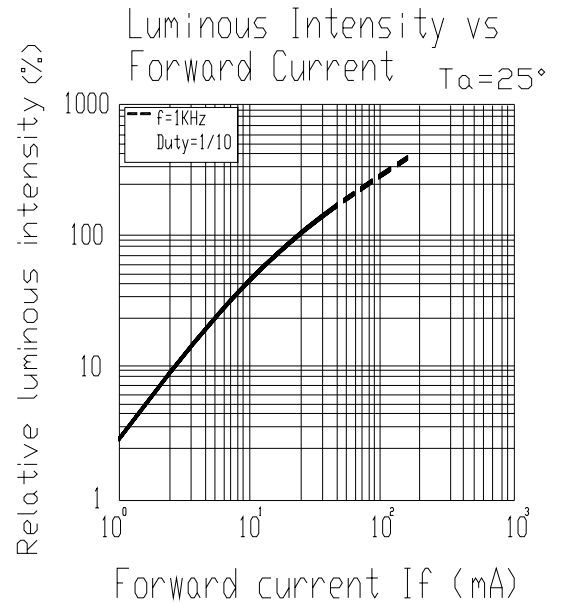
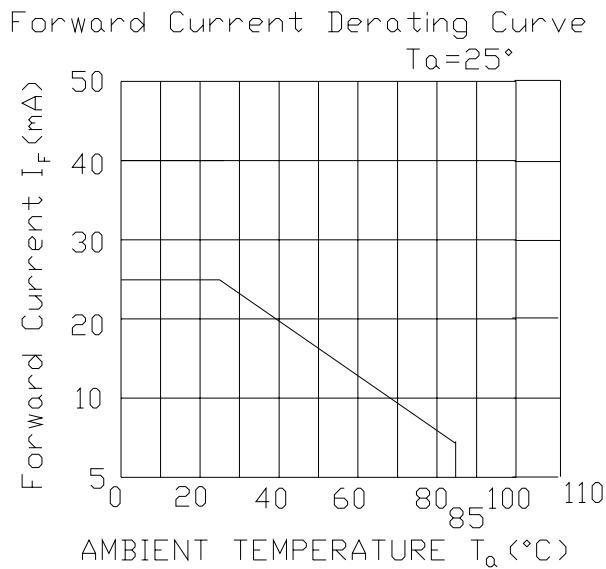
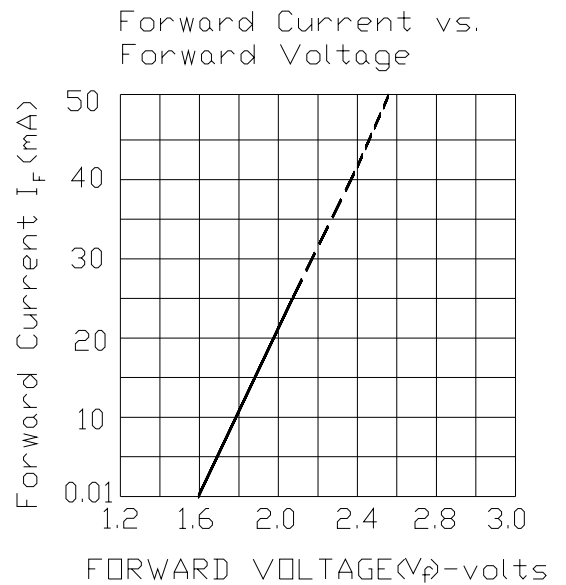
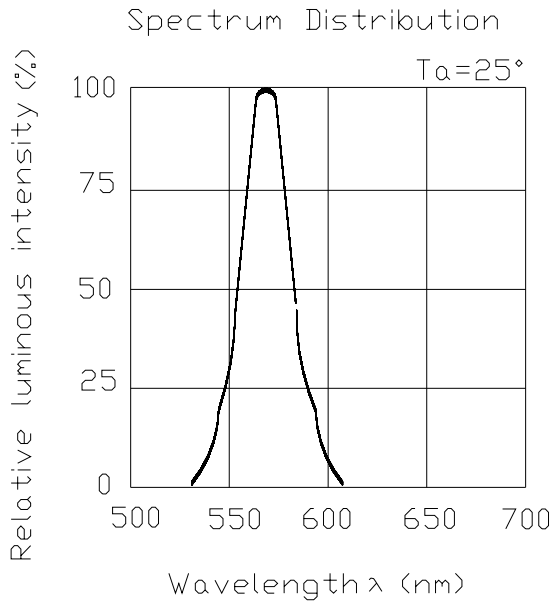

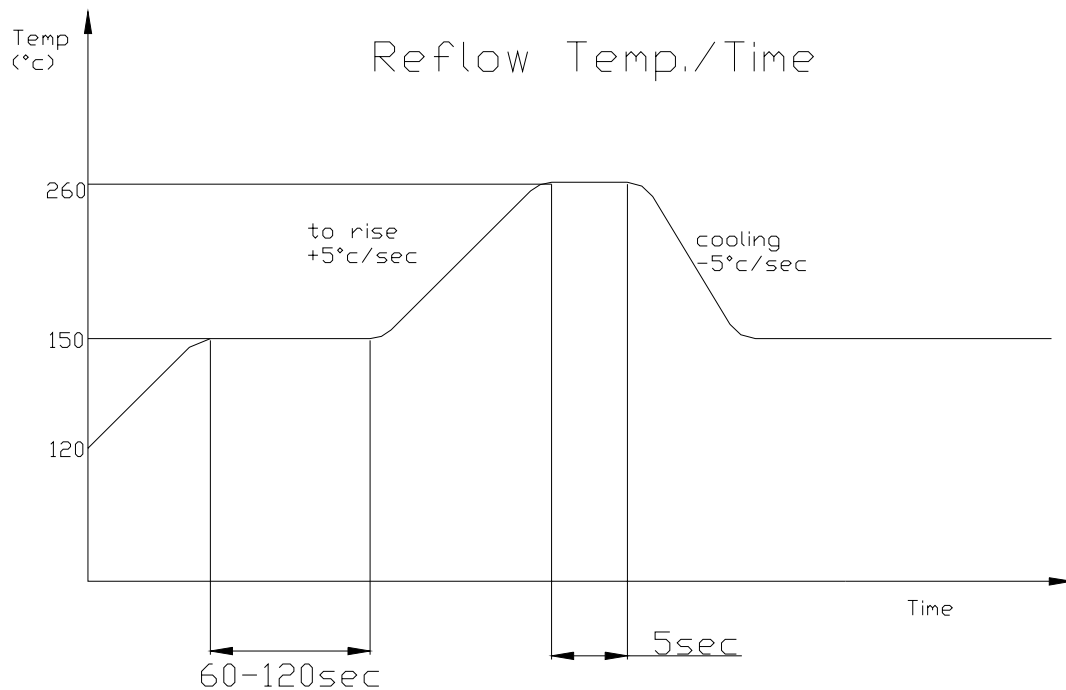
**■ Reflow Temp. / Time :****■ Soldering Iron :**

Basic spec is  $\leq 5$  sec when 260°C. If temperature is higher, time should be shorter (+10°C  $\rightarrow$  -1sec). Power dissipation of iron should be smaller than 15 W, and temperature should be controllable. Surface temperature of the device should be under 230 °C.

**■ Rework :**

1. Customer must finish rework within 5 sec under 260°C.
2. The head of iron can not touch copper foil.