



MIC2874

1.2A High-Brightness Flash LED Driver with Single-Wire Serial Interface

General Description

The MIC2874 is a high-current, high-efficiency flash LED driver. The LED driver current is generated by an integrated inductive boost converter with a 4MHz switching frequency which allows for the use of very small inductor and output capacitor. These features make the MIC2874 an ideal solution for high-resolution camera phone LED flash light driver applications.

MIC2874 operates in either flash or torch modes that can be controlled through the single-wire serial interface and/or external control pin. A robust single-wire serial interface allows the host processor to control the LED current and brightness. The MIC2874 is available in a 9-bump 1.30mm x 1.30mm WLCSP package.

Datasheets and support documentation are available on Micrel's web site at: www.micrel.com.

Features

- Up to 1.2A flash LED driving current
- Highly efficient synchronous boost driver
- Control through single-wire serial interface or external control pin
- Input voltage range: 2.7V to 5.5V
- True load disconnect
- Configurable safety time-out protection
- Output overvoltage protection (OVP)
- LED short detection and protection.
- 1 μ A shutdown current
- Available in 9-bump 1.30mm x 1.30mm WLCSP package

Applications

- Camera phones/mobile handsets
- Cell phones/smartphones
- LED light for image capture/auto focus/white balance
- Handset video light (torch light)
- Digital cameras
- Portable applications

Typical Application

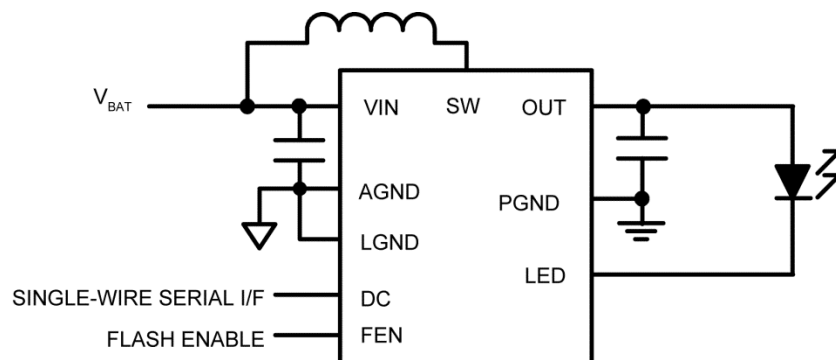

Ordering Information

Part Number	Marking Code	Operating Ambient Temperature Range	Package ⁽¹⁾
MIC2874YCS	74A	-40°C to +85°C	9-bump 1.30mm x 1.30mm WLCSP

Note:

1. WLCSP bump A1 identifier = “•”.

Pin Configuration

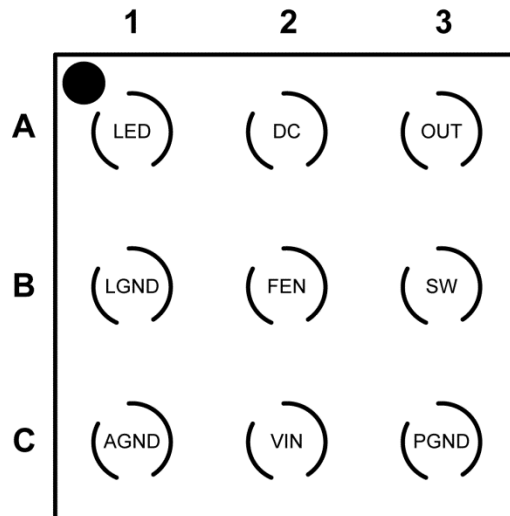

9-Bump 1.30mm x 1.30mm WLCSP (CS)
(Top View)

Pin Description

Pin Number	Pin Name	Pin Function
A1	LED	LED current sink pin. Connect the LED anode to OUT and cathode to this pin.
A2	DC	Single Wire Interface serial control input.
A3	OUT	Boost converter output pin to be connected to the anode of the LED. Connect a low ESR ceramic capacitor of at least 4.7μF at this pin to PGND.
B1	LGND	Linear Ground. LED current return path.
B2	FEN	Flash Mode Enable Pin. Asserting this pin high enables MIC2874 into the Flash mode. If this pin is left floating, it is pulled-down internally by a built-in 1μA current source when the device is enabled.
B3	SW	Inductor connection pin. It is connected to the internal power MOSFETs.
C1	AGND	Analog Ground.
C2	VIN	Supply Input pin. Connect a low ESR ceramic capacitor of at least 4.7μF at this pin to AGND.
C3	PGND	Power Ground. Inductor current return path.

Absolute Maximum Ratings⁽²⁾

Input Voltage (V_{IN})	-0.3V to +6.0V
General I/O Voltage (V_{FEN})	-0.3V to V_{IN}
V_{OUT} and V_{LED} Voltage	-0.3V to +6.0V
Single-Wire I/O Voltage (V_{DC})	-0.3V to V_{IN}
V_{SW} Voltage	-0.3V to +6.0V
Lead Temperature (soldering, 10sec.)	+260°C
Junction Temperature (T_J)	-40°C to +150°C
Storage Temperature (T_s)	-40°C to +150°C
ESD Rating ⁽⁵⁾	
HBM	2kV
MM	200V

Operating Ratings⁽³⁾

Input Voltage (V_{IN})	+2.7V to +5.5V
Enable Input Voltage (V_{FEN})	0V to V_{IN}
Single-Wire I/O Voltage (V_{DC})	0V to V_{IN}
Junction Temperature (T_J)	-40°C to +125°C
Operating Ambient Temperature (T_A)	-40°C to +85°C
Package Thermal Resistance	
1.30mm x 1.30mm WLCSP (θ_{JA}) ⁽⁴⁾	84°C/W
Power Dissipation (P_D)	Internally Limited ⁽⁴⁾

Electrical Characteristics⁽⁶⁾

$V_{IN} = 3.6V$; $L = 0.47\mu H$; $C_{OUT} = 4.7\mu F$, $I_{OUT} = 100mA$, $T_A = 25^\circ C$, **bold** values indicate $-40^\circ C \leq T_J \leq +125^\circ C$, unless otherwise noted.

Symbol	Parameter	Condition	Min.	Typ.	Max.	Units
Power Supply						
V_{IN}	Supply Voltage Range		2.7		5.5	V
V_{UVLO}	UVLO Threshold (rising)		2.41	2.53	2.68	V
	UVLO Hysteresis			180		mV
I_{STB}	Standby Current	$V_{DC} = 3.6V$, $V_{FEN} = 0V$, boost regulator and LED current driver both OFF.	150	185	220	μA
I_{SD}	Shutdown Current	$V_{DC} = 0V$		1	2	μA
D_{MAX}	Maximum Duty Cycle		82	86	90	%
D_{MIN}	Minimum Duty Cycle			6.4		%
I_{SW}	Switch Current Limit	$V_{IN} = V_{OUT} = 2.7V$		4.1		A
PMOS	Switch On-Resistance	$I_{SW} = 100mA$		125		m Ω
NMOS		$I_{SW} = 100mA$				
I_{SW_LK}	Switch Leakage Current	$V_{DC} = 0V$, $V_{SW} = 5.5V$		0.01	1	μA
F_{SW}	Oscillator Frequency		3.6	4	4.4	MHz

Notes:

- Exceeding the absolute maximum rating may damage the device.
- The device is not guaranteed to function outside its operating rating.
- The maximum allowable power dissipation of any T_A (ambient temperature) is $P_{D(max)} = (T_{J(max)} - T_A) / \theta_{JA}$. Exceeding the maximum allowable power dissipation will result in excessive die temperature, and the regulator will go into thermal shutdown.
- Devices are ESD sensitive. Handling precautions recommended. Human body model, 1.5k Ω in series with 100pF.
- Specification for packaged product only.

Electrical Characteristics⁽⁶⁾ (Continued)

$V_{IN} = 3.6V$; $L = 0.47\mu H$; $C_{OUT} = 4.7\mu F$, $I_{OUT} = 100mA$, $T_A = 25^\circ C$, **bold** values indicate $-40^\circ C \leq T_J \leq +125^\circ C$, unless otherwise noted.

Symbol	Parameter	Condition	Min.	Typ.	Max.	Units
T_{SD}	Overtemperature Shutdown Threshold			155		$^\circ C$
	Overtemperature Shutdown Hysteresis			15		$^\circ C$
T_{TO}	Safety Timeout Shutdown	Default timer setting		1.25		s
I_{TO}	Safety Timer Current Threshold	Default current threshold setting		250		mA
V_{LBVD}	Low-Battery Voltage Detection Threshold	Default LBVD threshold setting		3.0		V
	Low-Battery Voltage Detection Threshold Accuracy	All low-battery voltage detection threshold settings		50		mV
V_{SHORT}	LED Short-Circuit Detection Voltage Threshold	$V_{OUT} - V_{LED}$	1.55	1.7	1.85	V
I_{TEST}	LED Short-Circuit Detection Test Current		1.6	2	2.7	mA
Current Sink Channel						
	Channel Current Accuracy	$V_{OUT} = 4.2V$, $I_{LED} = 0.20A$	-6		6	%
		$V_{OUT} = 4.2V$, $I_{LED} = 1.0A$	-8		8	
V_{LED}	Current Sink Voltage Dropout	Boost mode		250		mV
FEN Control Pin						
V_{FEN}	FEN Threshold Voltage	FLASH ON	1.3			V
		FLASH OFF			0.6	
	FEN Pull-down Current	$V_{FEN} = 5.5V$		1.3	5	μA

Electrical Characteristics – Single-Wire Interface (Guaranteed by Design)

$V_{IN} = 3.6V$; $L = 0.47\mu H$; $C_{OUT} = 4.7\mu F$, $I_{OUT} = 100mA$, $T_A = 25^\circ C$, **bold** values indicate $-40^\circ C \leq T_J \leq +125^\circ C$, unless otherwise noted.

Symbol	Parameter	Condition	Min.	Typ.	Max.	Units
V_{DC}	LOW-Level Input Voltage				0.4	V
	HIGH-Level Input Voltage		1.3			V
	DC Pull-Down Current	$V_{DC} = 5.5V$		2.8	5	μA
T_{ON}	ON Time		0.1		72	μs
T_{OFF}	OFF Time		0.1		72	μs
T_{LAT}	Latch Time		97		324	μs
T_{END}	END Time		405			μs

Typical Characteristics

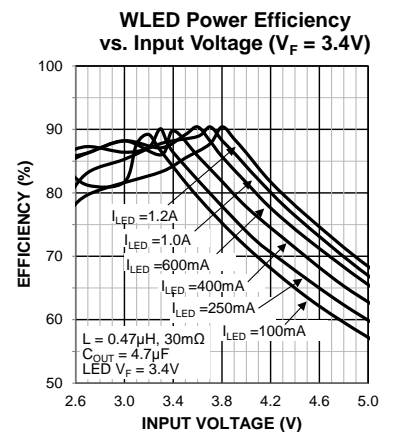
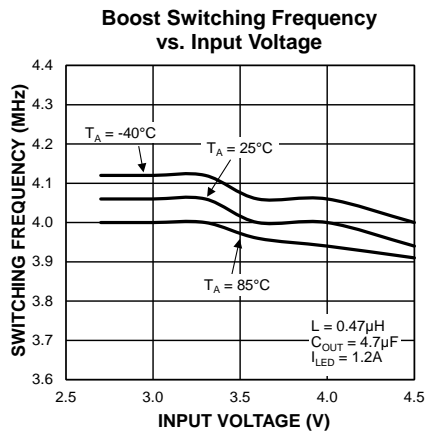
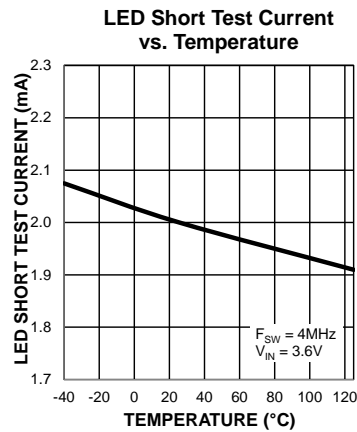
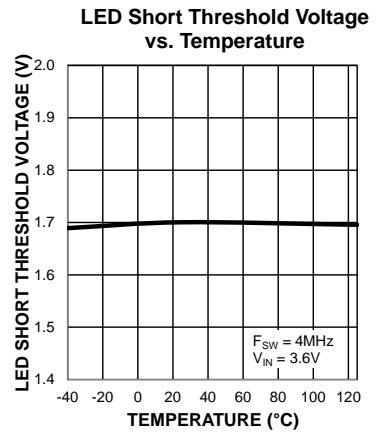
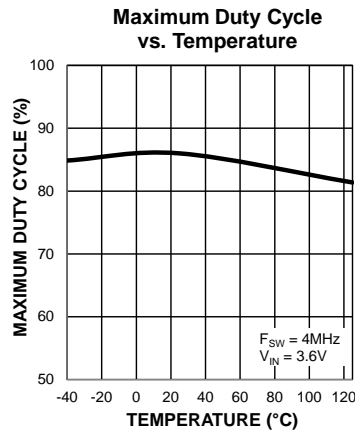
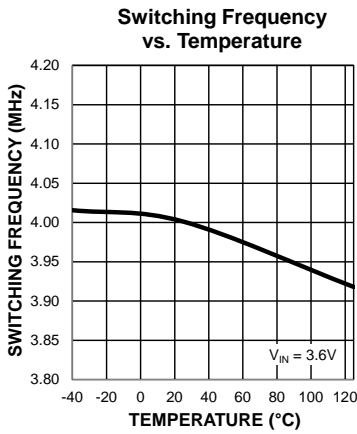
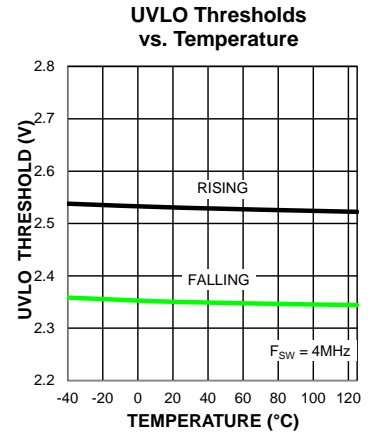
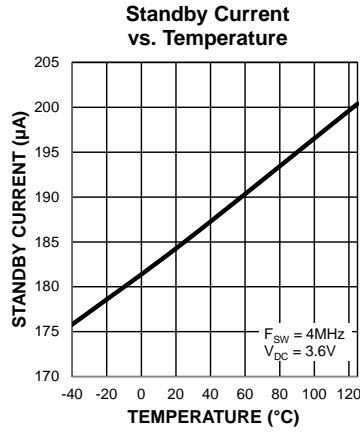
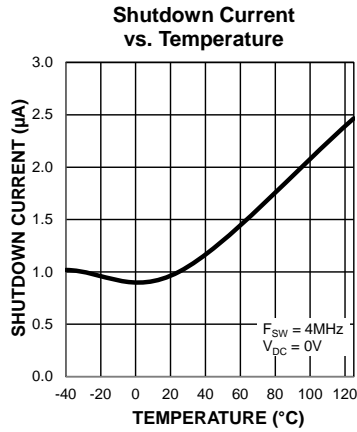

Typical Characteristics (Continued)

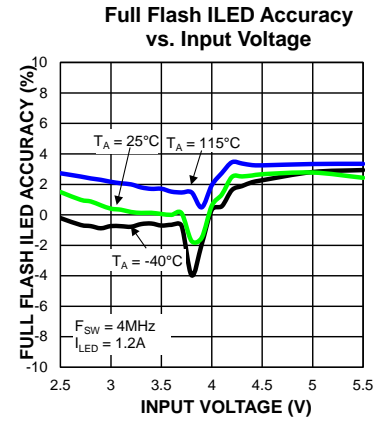
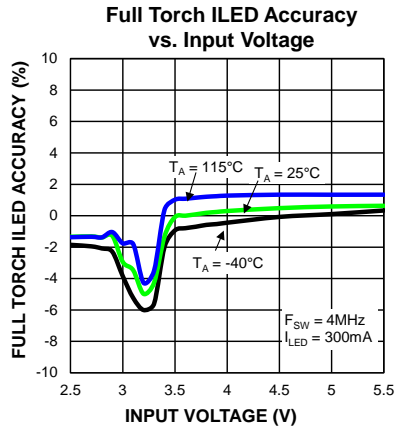
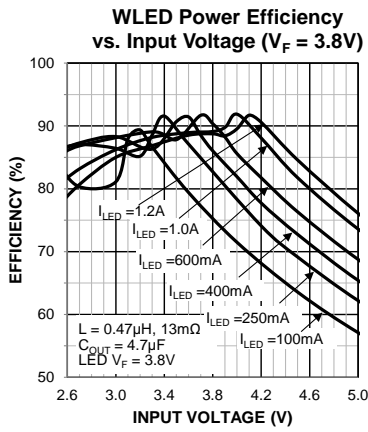

Functional Characteristics

Flash Mode Turn-On Sequence (Boost Mode)

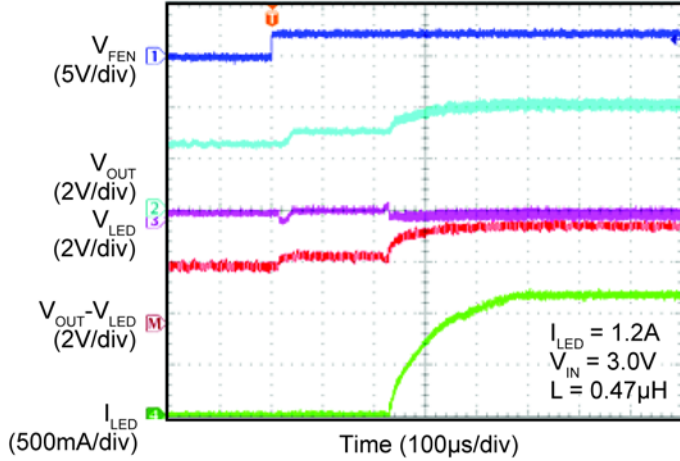

Flash Mode Turn-On Sequence (Linear Mode)

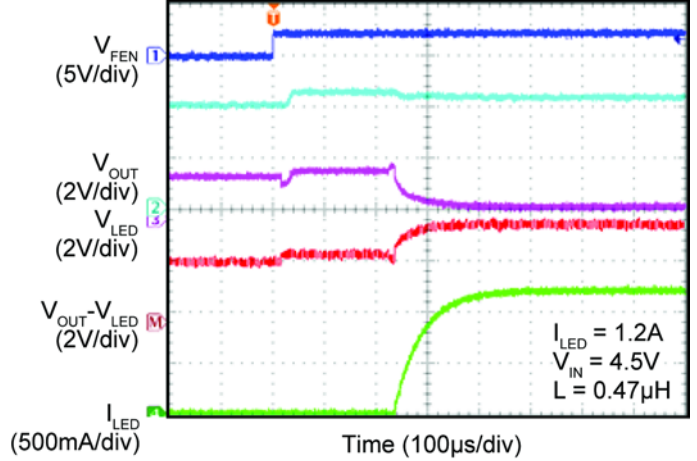

Torch Mode Turn-On Sequence (Boost Mode)

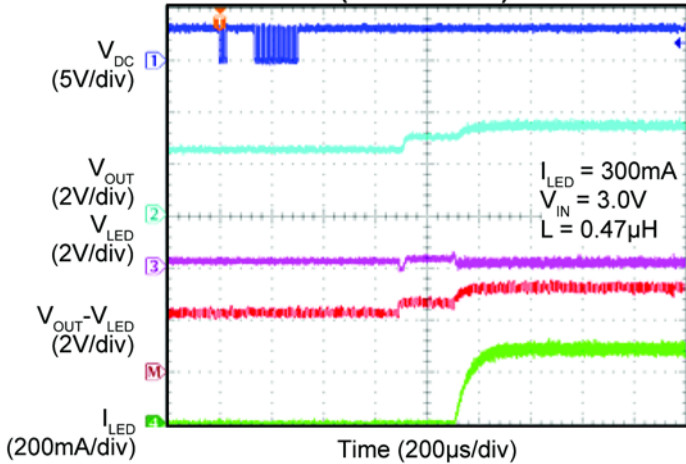

Torch Mode Turn-On Sequence (Linear Mode)

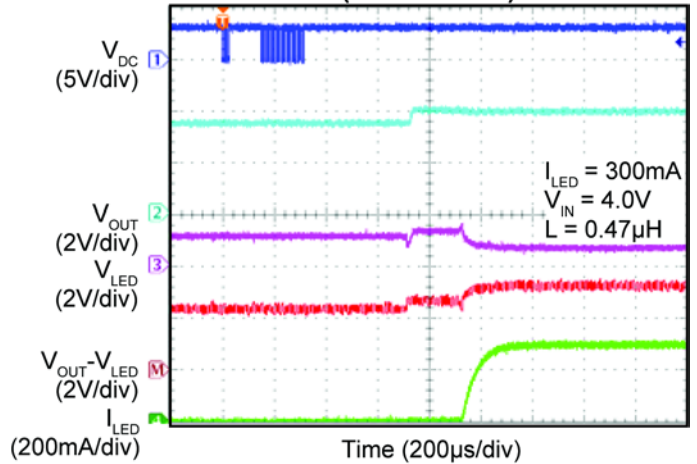

Flash Safety Timer at 1250ms

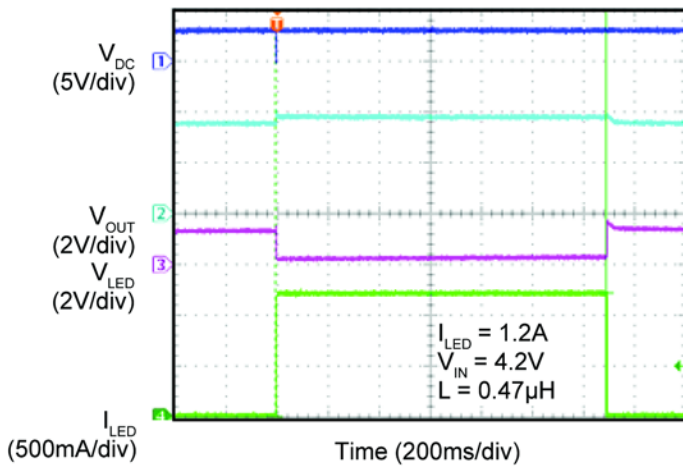

Flash Safety Timer at 156ms

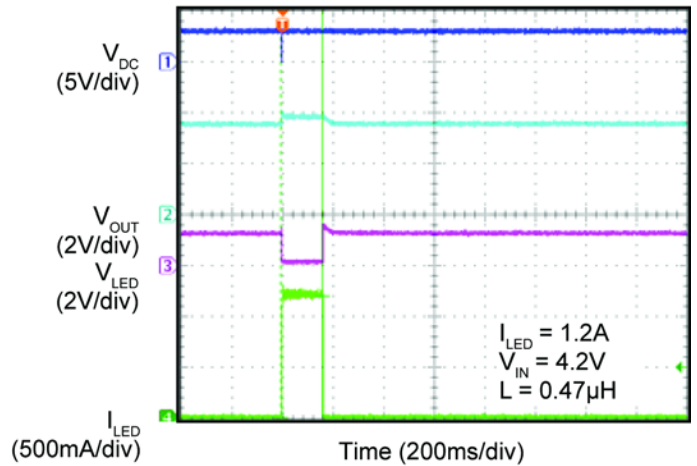

Functional Characteristics (Continued)

LED Short-Circuit Protection
(LED is Shorted by 0Ω)

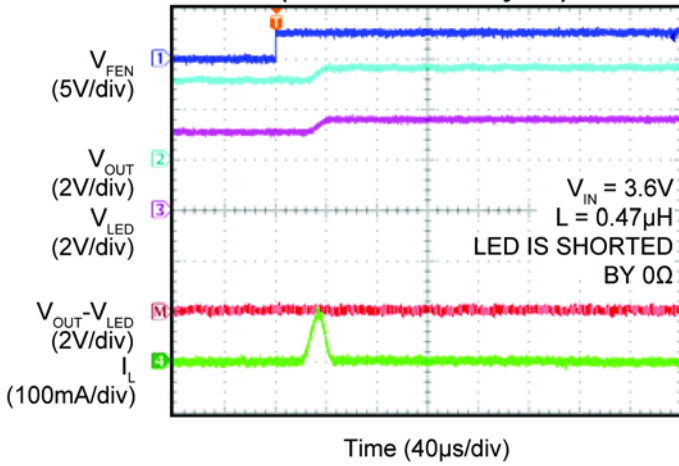

LED Short-Circuit Protection
(LED is Shorted by 620Ω)

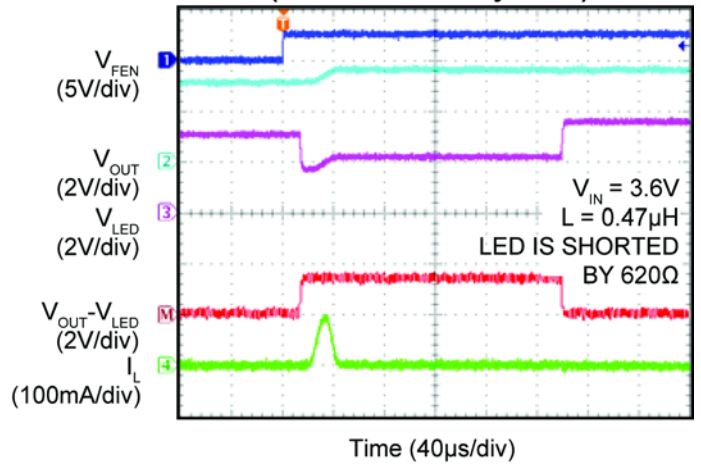

Load Disconnect at Shutdown
($V_{IN} = 2.7V$)

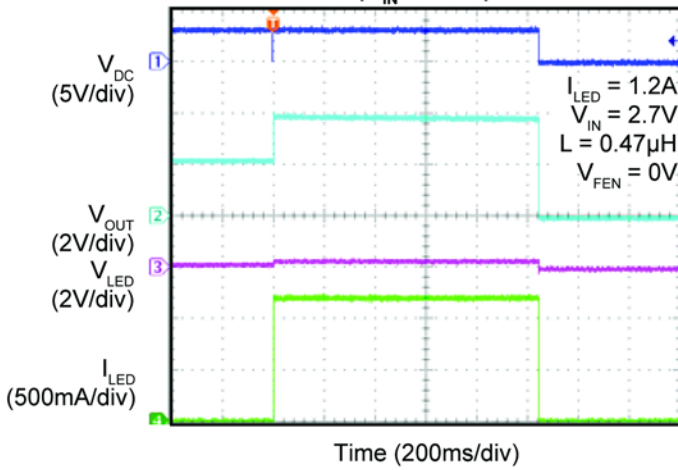

Load Disconnect at Shutdown
($V_{IN} = 5.0V$)

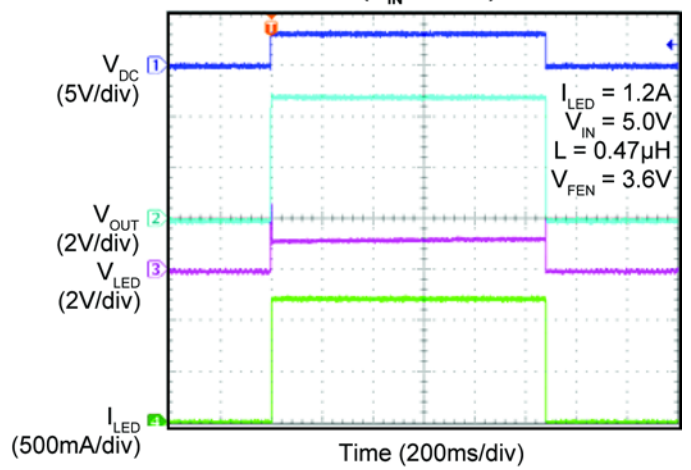

V_{OUT} Over-Voltage Protection
(Over-voltage during Start-up)

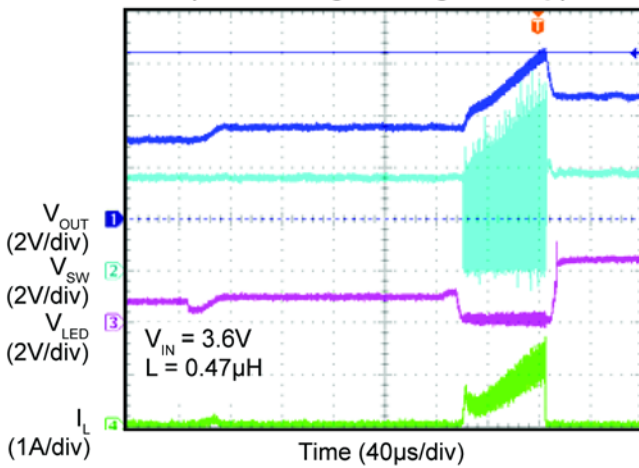

V_{OUT} Over-Voltage Protection
(Over-voltage after Start-up)

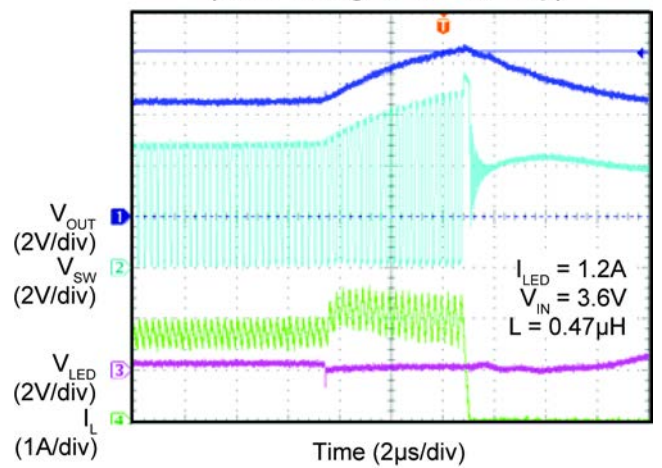

Functional Characteristics (Continued)

**Load Transient
(Torch 63mA to Flash 1.2A)**

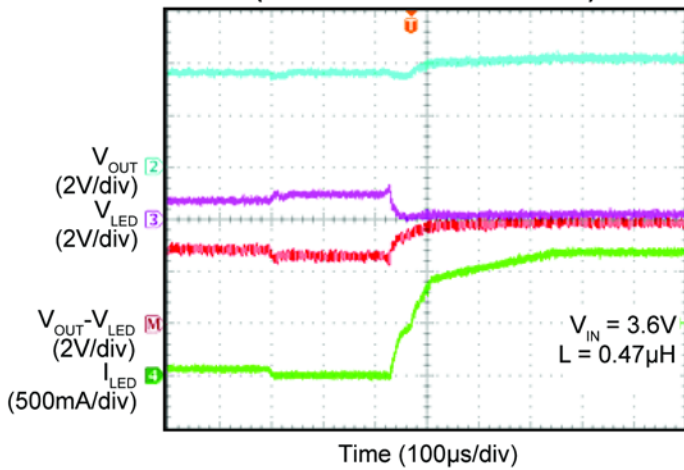

**Load Transient
(Flash 1.2A to Torch 63mA)**

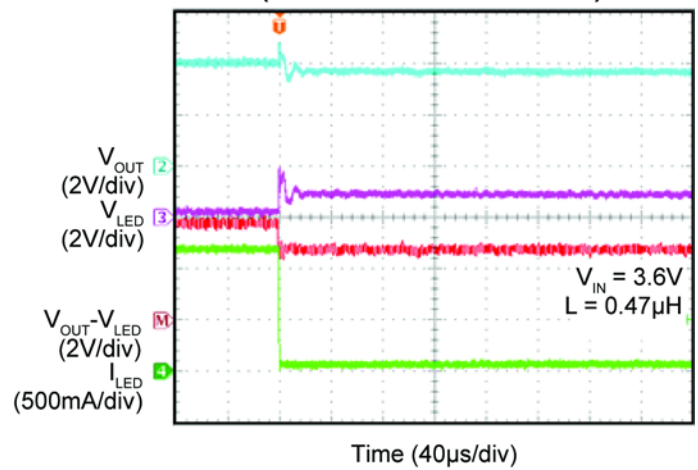

**Line Transient
(V_{IN} Changes from 2.7V to 5.5V)**

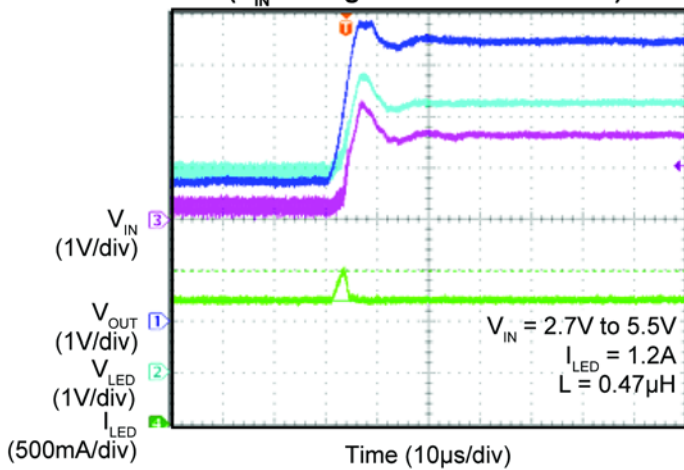

**Line Transient
(V_{IN} Changes from 5.5V to 2.7V)**

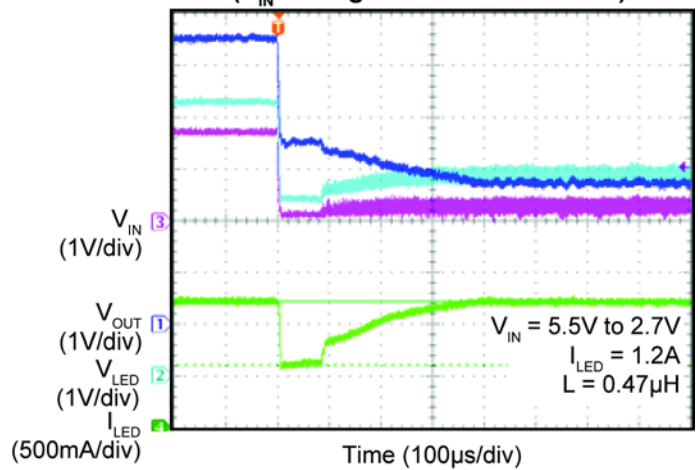

Switch Current Limit

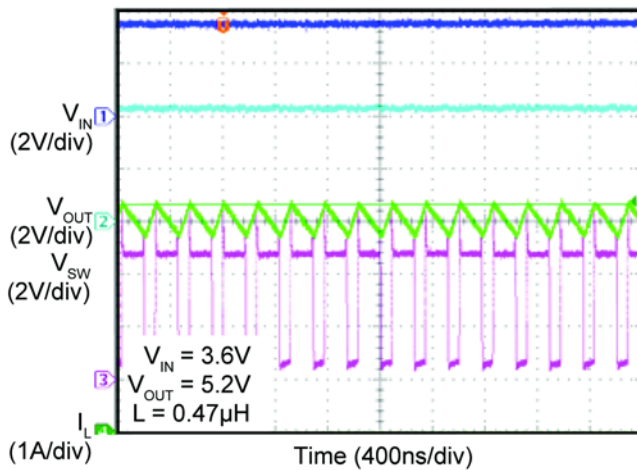

Functional Diagram

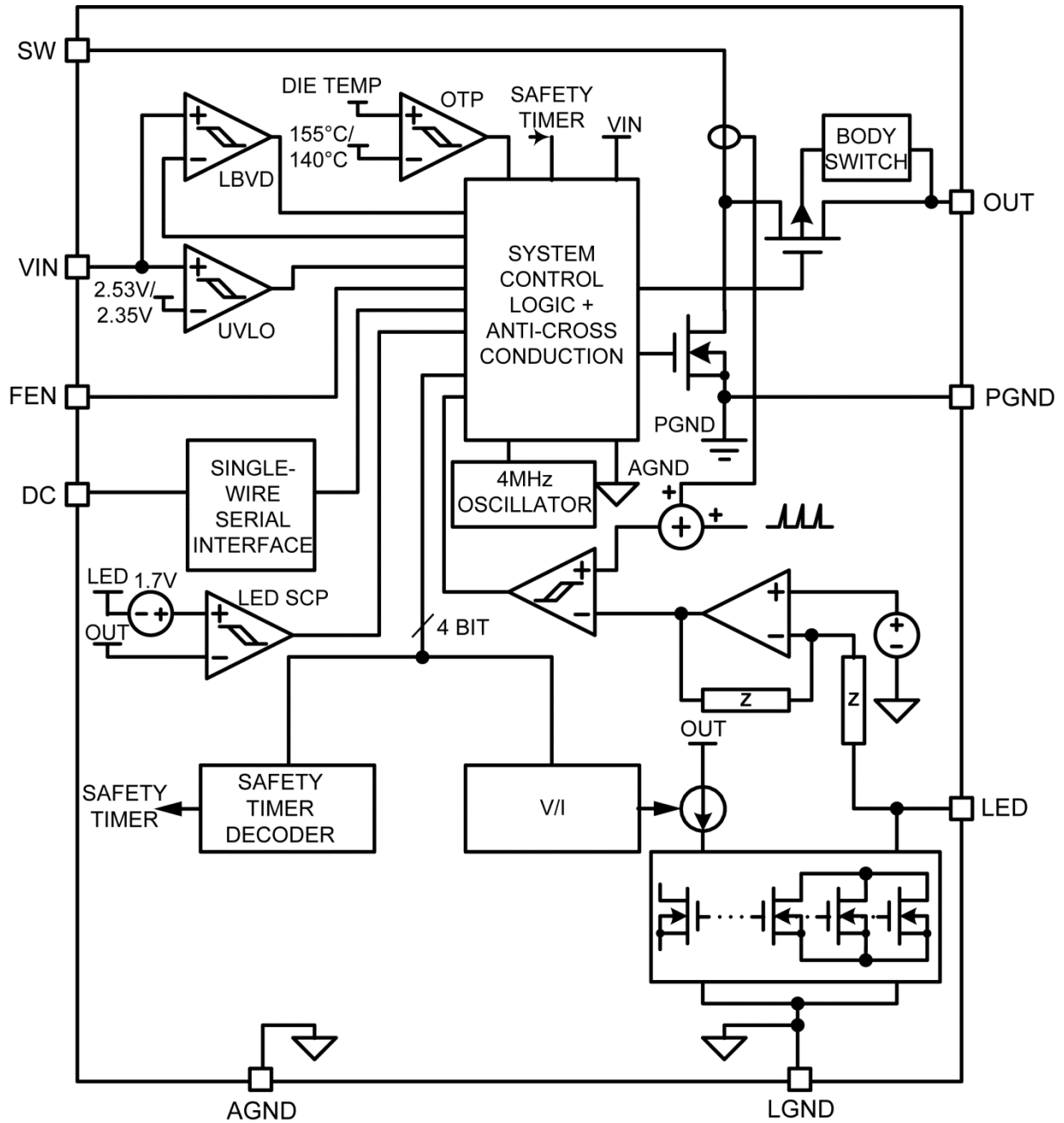

Figure 1. Simplified MIC2874 Functional Block Diagram

Functional Description

VIN

The input supply provides power to the internal MOSFETs gate drive and controls circuitry for the switch-mode regulator. The operating input voltage range is from 2.7V to 5.5V. A 4.7 μ F low-ESR ceramic input capacitor should be connected from VIN to AGND as close to MIC2874 as possible to ensure a clean supply voltage for the device. The minimum voltage rating of 10V is recommended for the input capacitor.

SW

The MIC2874 has internal low-side and synchronous MOSFET switches. The switch node (SW) between the internal MOSFET switches connects directly to one end of the inductor and provides the current paths during switching cycles.

The other end of the inductor is connected to the input supply voltage. Due to the high-speed switching on this pin, the switch node should be routed away from sensitive nodes wherever possible.

LGND

This is the ground path of the LED current sink. It should be connected to the AGND on the PCB. The current loop of the analog ground should be separated from that of the power ground (PGND). LGND and AGND should be connected to PGND at a single point.

AGND

This is the ground path for the internal biasing and control circuitry. AGND should be connected to the LGND directly. The current loop of the analog ground should be separated from that of the power ground (PGND). The AGND and LGND should be connected to PGND at a single point.

PGND

The power ground pin is the ground path for the high current in the boost switch. The current loop for the power ground should be as small as possible and separate from the analog ground (AGND) loop as applicable.

OUT

Boost converter output pin which is connected to the anode of the LED. A low-ESR ceramic capacitor of 4.7 μ F or larger should be connected from OUT to PGND as close as possible to the MIC2874. The minimum voltage rating of 10V is recommended for the output capacitor.

LED

The current sink pin for the LED. The LED anode is connected to the OUT pin and the LED cathode is connected to this pin.

DC

The DC is a single multiplexed device enable and serial data control pin used for functional control and communication in GPIO limited applications. When the DC pin is used as a hardware device enable pin, a logic high signal on the DC pin enables the device, and a logic low signal on the DC pin disables the device. When the DC pin is used as the single-wire serial interface digital control pin, a combination of bit edges and the period between edges is used to communicate a variable length data word across the single wire. Each word is transmitted as a series of pulses, with each pulse incrementing an internal data counter. A stop sequence consisting of an inactive period is used to latch the data word internally. Two data words in series received are then used to set a specific register with specific value for controlling specific function. The MIC2874 supports five writeable registers for controlling flash mode, torch mode, safety timer duration, safety timer threshold current, and low-battery threshold.

An address/data frame is used to improve protection against erroneous writes where communications are in error. When DC is in a low state and no data is detected for longer than 405 μ s, the MIC2874 will automatically go into a low-power SHUTDOWN state, simultaneously resetting all internal registers to their default states.

FEN

FEN is the hardware enable pin for flash mode. A logic low-to-high transition on FEN pin can initiate the MIC2874 in flash mode. If FEN is left floating, it is pulled down internally by a built-in 1 μ A current source when the device is enabled. Flash mode is terminated when FEN is pulled low or left floating, and the flash register is cleared.

Application Information

MIC2874 can drive a high-current flash WLED in either flash mode or torch mode.

Boost Converter

The internal boost converter is turned on/off automatically when the LED driver is activated/de-activated without any exception.

The boost converter is an internally-compensated current-mode PWM boost converter running at 4MHz. It is for stepping up the supply voltage to a high enough value at the OUT pin to drive the LED current. If the supply voltage is high enough, the synchronous switch of the converter is then fully turned on. In this case, all the excessive voltage is dropped over the linear LED driver.

Flash Mode

The maximum and default current levels in the flash mode are 1.2A and 1A respectively. The flash mode current can be initiated by asserting FEN pin high, or by setting the flash control register (address 1), for the desired flash duration, subjected to the safety timeout setting. The flash mode current is terminated when the FEN pin is brought low and the flash register is cleared, or when the configurable safety timer expires.

Flash mode current can be adjusted to a fraction of the maximum flash mode current level by selecting the desired value in the flash control register through the single-wire serial interface.

Torch Mode

By default, the maximum torch mode level is 300mA. The torch mode operation is activated by setting the torch control register (address 2) for the desired duration. The torch mode current is terminated when the torch register is cleared or when the configurable safety timer expires.

Like the flash mode current, the torch mode current can be set to a fraction of the maximum torch mode current level by selecting the desired torch current in the torch control register (address 2) via the single-wire serial interface.

Configurable Safety Timer

The flash safety timeout feature automatically shuts down the LED current after the safety timer duration is expired if the programmed LED current exceeds a certain current threshold. Both the current threshold and the timer duration are programmable via the safety timer registers (addresses 3 and 5).

Low-Battery Voltage Detection (LBVD)

When the VIN voltage drops below the LBVD threshold (default = 3.0V) in flash or torch mode, the LED current driver is disabled. The LED driver can be resumed by raising the VIN above the LBVD threshold and toggling the corresponding flash or torch command. The LBVD threshold is adjustable thru the LBVD control register

(address 4).

Overvoltage Protection

When the output voltage rises above an internal OVP threshold, MIC2874 is latched off automatically to avoid permanent damage to the IC. To clear the latched off condition, either power cycle the MIC2874 or assert the DC pin low.

Short-Circuit Detection

Each time before enabling the LED driver, the MIC2874 performs the short circuit test by driving the flash LED with a small (2mA typical) current for 200 μ s. If ($V_{OUT} - V_{LED}$) is less than 1.7V at the end of the short-circuit test, then the LED is considered to be shorted and MIC2874 will ignore the flash and/or torch mode command. Note that the short-circuit test is carried out every time prior to flash and torch mode but the result is not latched.

Thermal Shutdown

When the internal die temperature of MIC2874 reaches 155°C, the LED driver is disabled until the die temperature falls below 140°C and either FEN pin, FEN register, TEN register, or VIN is toggled.

Single-Wire Interface

The single-wire interface allows the use of a single multiplexed enable and data pin (DC) for control and communication in GPIO limited applications. The interface is implemented using a simple mechanism allowing any open drain or directly driven GPIO to control the MIC2874.

The MIC2874 uses the single-wire interface for simple command and control functions. The interface provides fast access to write only registers with protection features to avoid potentially erroneous data writes and improve robustness. When DC is in a low state and no data is detected for longer than 405 μ s, the MIC2874 will automatically go into a low-power SHUTDOWN state, simultaneously resetting internal registers to default states.

Overview

The single-wire interface relies on a combination of bit edges and the period between edges in order to communicate across a single wire. Each word is transmitted as a series of pulses, with each pulse incrementing an internal data counter. A stop sequence consisting of an inactive period of DC pin remaining high is used to latch the data word internally. An address and data framing format is used to improve protection against erroneous writes by enforcing address and data field lengths as well as the timing duration between them.

Timing is designed such that when communicating with a device using a low cost on chip oscillator, the worst case minimum and maximum conditions can be easily met within the wide operating range of the oscillator. Using this method guarantees that the device can always detect the delay introduced by the communication master.

Idle States and Error Conditions

In shutdown mode, the MIC2874 is in a reset condition with all functions off while consuming minimal power. Register settings are reset to default state when coming out of shutdown state. In idle mode, all register settings persist and all MIC2874 functions continue in their current state. Table 1 summarises the difference between the two idle modes:

Table 1. Differences between Idle Modes

Mode	Shutdown	Idle
V _{DC}	Low	High
I _{SUPPLY} (all functions off)	1µA	230µA
Register State	Default	Persist
Start-Up Time	1µs	100ns

Idle mode is entered automatically at the end of a communication frame by holding DC high for $\geq T_{END}$, by enabling the device by bringing DC high when in shutdown mode, or when an error is detected by the single-wire interface logic.

Shutdown mode can be entered at any time by pulling down DC for $\geq T_{END}$, discarding any current communication and resetting the internal registers. If a communication is received before the shutdown period but after the T_{LAT} period, the communication is discarded. This state is also used to create an internal error state to avoid erroneously latching data where the communication process cannot be serviced in time. Additionally, each register has a maximum value associated with it. If the number of bits clocked in exceeds the maximum value for the register, the data is assumed to be in error and the data is discarded.

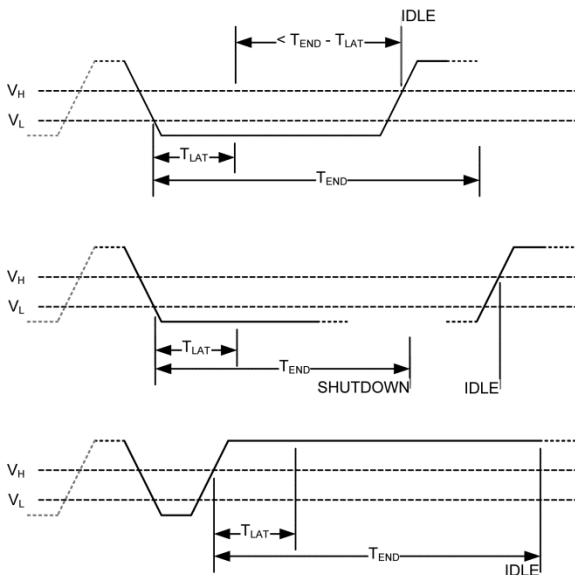

Figure 2. Abort, Shutdown and Idle Timing Waveforms

Communication Details

The serial interface requires delimiters to indicate the start of frame, data as a series of pulses, and end of frame indicated by a lack of activity for longer than T_{LAT} . The start of frame is the first high to low transition of DC when in idle mode. The first rising edge resets the internal data counter to 0.

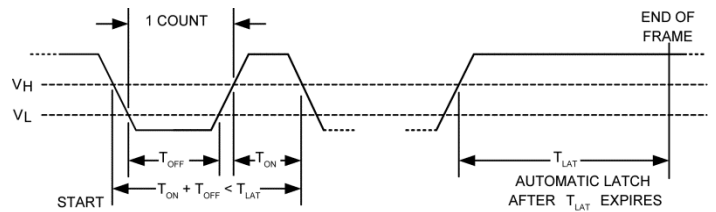

Figure 3. Data Word Pulse Timing

A pulse is delimited by the signal first going below V_L and then above V_H within the latch timeout T_{LAT} . During this transition, minimum on (T_{ON}) and off (T_{OFF}) periods are observed to improve tolerance to glitches. Each rising edge increments the internal data register. Data is automatically latched into internal shadow address or data registers after an inactivity period of DC remaining high for longer than T_{LAT} .

To send register write commands, the address and data are entered in series as two data words using the above pattern, with the second word starting after the first latch period has expired. After the second word is entered, the IDLE command should be issued by leaving the DC pin high for $\geq T_{END}$ to indicate the stop sequence of the address/data words frame.

After receiving the stop sequence, the internal registers decode and update cycle is started, with the shadow register values being transferred to the decoder. Figure 4 shows an example of entering a write of data 5 to address 3.

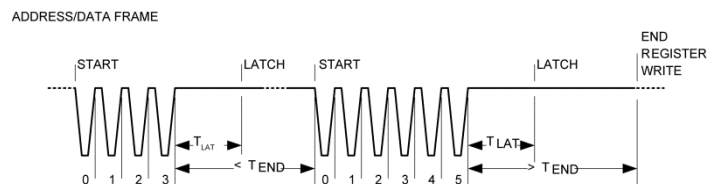

Figure 4. Communication Timing Example of Entering Write for Data 5 to Address 3

Only correctly formatted address/data combination will be treated as a valid frame and processed by the MIC2874. Any other input, such as a single data word followed by T_{END} , or three successive data words will be discarded by the target hardware as an erroneous entry. Additionally, any register write to either an invalid register or with invalid register data will also be discarded.

MIC2874 Registers

The MIC2874 supports five writable registers for controlling the torch and the flash modes of operation as shown in Table 2. Note that register addressing starts at 1. Writing any value above the maximum value shown for each registers will cause an invalid data error and the frame will be discarded.

Table 2. Five Writable Registers of MIC2874

Address	Name	Max. Value	Description
1	FEN/FCUR	31	Flash Enable/Current
2	TEN/TCUR	31	Torch Enable/Current
3	STDUR	7	Safety Timer Duration
4	LB_TH	9	Low Battery Voltage Detection Threshold
5	ST_TH	5	Safety Timer Threshold

Flash Current Register (FEN/FCUR: default 4)

The flash current register enables and sets the flash mode current level. Valid values are 0 to 31; values 0-15 will set the flash current without enabling the flash (such that it can be triggered externally), values 16-31 will set the flash current and enable the flash. The flash current register maps into the internal FEN and FCUR registers as shown in the table below. Table 3 describes the relationship between the flash current and the FCUR register setting.

Table 3. Flash Current Register Mapping into Internal FEN and FCUR Registers, and Relationship between Flash Current and the FCUR Register Setting

FEN/FCUR[4:0] Value				I _{FLASH} (A)
Dec.	Binary	FEN[4]	FCUR[3:0]	
0	00000	0	0000	1.200
1	00001	0	0001	1.150
2	00010	0	0010	1.100
3	00011	0	0011	1.050
4	00100	0	0100	1.000
5	00101	0	0101	0.950
6	00110	0	0110	0.900
7	00111	0	0111	0.850
8	01000	0	1000	0.800
9	01001	0	1001	0.750
10	01010	0	1010	0.700
11	01011	0	1011	0.650
12	01100	0	1100	0.600
13	01101	0	1101	0.550
14	01110	0	1110	0.400

FEN/FCUR[4:0] Value				I _{FLASH} (A)
Dec.	Binary	FEN[4]	FCUR[3:0]	
15	01111	0	1111	0.250
16	10000	1	0000	1.200
17	10001	1	0001	1.150
18	10010	1	0010	1.100
19	10011	1	0011	1.050
20	10100	1	0100	1.000
21	10101	1	0101	0.950
22	10110	1	0110	0.900
23	10111	1	0111	0.850
24	11000	1	1000	0.800
25	11001	1	1001	0.750
26	11010	1	1010	0.700
27	11011	1	1011	0.650
28	11100	1	1100	0.600
29	11101	1	1101	0.550
30	11110	1	1110	0.400
31	11111	1	1111	0.250

Torch Current Register (TEN/TCUR: default 4)

The torch current register enables and sets the torch mode current level. Valid values are 0 to 31; values 0 – 15 will set the torch current without enabling the torch (such that it can be triggered by setting the internal TEN register value to 1), values 16 – 31 will set the torch current and enable the torch. A value of 0 at the internal TEN register will disable the torch. The torch current register maps into the internal TEN and TCUR registers as shown in Table 4. The table also describes the relationship between the torch current and the TCUR register setting.

Table 4. Torch Current Register Mapping into Internal TEN and TCUR Registers, and Relationship between Torch Current and the TCUR Register Setting

TEN/TCUR[4:0] Value				I _{TORCH} (mA)
Dec.	Binary	TEN[4]	TCUR[3:0]	
0	00000	0	0000	300.0
1	00001	0	0001	287.5
2	00010	0	0010	275.0
3	00011	0	0011	262.5
4	00100	0	0100	250.0
5	00101	0	0101	237.5
6	00110	0	0110	225.0
7	00111	0	0111	212.5
8	01000	0	1000	200.0
9	01001	0	1001	187.5
10	01010	0	1010	175.0
11	01011	0	1011	162.5
12	01100	0	1100	150.0
13	01101	0	1101	137.5
14	01110	0	1110	100.0
15	01111	0	1111	62.5
16	10000	1	0000	300.0
17	10001	1	0001	287.5
18	10010	1	0010	275.0
19	10011	1	0011	262.5
20	10100	1	0100	250.0
21	10101	1	0101	237.5
22	10110	1	0110	225.0
23	10111	1	0111	212.5
24	11000	1	1000	200.0
25	11001	1	1001	187.5
26	11010	1	1010	175.0
27	11011	1	1011	162.5
28	11100	1	1100	150.0
29	11101	1	1101	137.5
30	11110	1	1110	100.0
31	11111	1	1111	62.5

Safety Timer Duration Register (STDUR: default 7)

The safety timer duration register sets the duration of the flash and torch mode when the LED current exceeds the programmed threshold current. Valid values are 0 for the minimum timer duration to 7 for the maximum duration.

Table 5. Safety Timer Duration Register Setting and Safety Timer Duration

Value		STDUR[2:0] (binary)	Timeout (ms)
Dec.	Binary		
0	000	000	156.25
1	001	001	312.5
2	010	010	468.75
3	011	011	625
4	100	100	781.25
5	101	101	937.5
6	110	110	1093.75
7	111	111	1250

Low-Battery Threshold Register (LB_TH: default 1)

The LB_TH register sets the supply threshold voltage below which the internal low battery flag is asserted and the LED current driver is disabled. Table 6 shows the threshold values that correspond to the register settings. Setting 0 is reserved for disabling the function, and settings between 1 and 9 inclusively enable and set the LB_TH value between 3.0V and 3.8V with 100mV resolution.

Table 6. Low-Battery Threshold Register Setting and Supply Threshold Voltage

Value		LB_TH[3:0]	V _{BAT} Threshold (V)
Dec.	Binary		
0	0000	0000	Disabled
1	0001	0001	3.0
2	0010	0010	3.1
3	0011	0011	3.2
4	0100	0100	3.3
5	0101	0101	3.4
6	0110	0110	3.5
7	0111	0111	3.6
8	1000	1000	3.7
9	1001	1001	3.8

Safety Timer Threshold Current Register (ST_TH: default 4)

Safety timer threshold current determines the amount of LED current flowing through the external LED before the internal LED safety timer is activated. Setting ST_TH to 0 disables the safety timer function, and setting the register to values 1 to 5 set the safety time threshold current 100mA to 300mA in 50mA steps.

Table 7. Safety Timer Threshold Current Register Setting and Safety Timer Threshold Current

Value		ST_TH[2:0]	Safety Timer Threshold Current (mA)
Dec.	Binary		
0	000	000	Disabled
1	001	001	100
2	010	010	150
3	011	011	200
4	100	100	250
5	101	101	300

Component Selection

Inductor

Inductor selection should strike a balance between efficiency, stability, cost, size, and rated current. Since the boost converter is compensated internally, the recommended inductance of L is limited from 0.47µH to 1µH to ensure system stability, and a 0.47µH inductor is typically recommended. It is usually a good balance between these considerations.

A large inductance value reduces the peak-to-peak inductor ripple current hence the output ripple voltage and the LED ripple current. This also reduces both the DC loss and the transition loss at the same inductor's DC resistance (DCR). However, the DCR of an inductor usually increases with the inductance in the same package size. This is due to the longer windings required for an increase in inductance. Since the majority of the input current passes through the inductor, the higher the DCR the lower the efficiency is, and more significantly at higher load currents. On the other hand, inductor with smaller DCR but the same inductance usually has a larger size. The saturation current rating of the selected inductor must be higher than the maximum peak inductor current to be encountered and should be at least 20% to 30% higher than the average inductor current at maximum output current.

Input Capacitor

A ceramic capacitor of 4.7µF or larger with low ESR is recommended to reduce the input voltage ripple to ensure a clean supply voltage for the device. The input capacitor should be placed as close as possible to the MIC2874 VIN pin with short trace for good noise performance. X5R or X7R type ceramic capacitors are recommended for better tolerance over temperature. The Y5V and Z5U type temperature rating ceramic capacitors are not recommended due to their large reduction in capacitance over temperature and increased resistance at high frequencies. These reduce their ability to filter out high-frequency noise. The rated voltage of the input capacitor should be at least 20% higher than the maximum operating input voltage over the operating temperature range.

Output Capacitor

Output capacitor selection is also a trade-off between performance, size, and cost. Increasing output capacitor will lead to an improved transient response, however, the size and cost also increase. The output capacitor is preferred in the range of 2.2µF to 10µF with ESR from 10mΩ to 50mΩ, and a 4.7µF ceramic capacitor is typically recommended. X5R or X7R type ceramic capacitors are recommended for better tolerance over temperature. The Y5V and Z5U type ceramic capacitors are not recommended due to their wide variation in capacitance

over temperature and increased resistance at high frequencies. The rated voltage of the output capacitor should be at least 20% higher than the maximum operating output voltage over the operating temperature range.

Power Dissipation Consideration

As with all power devices, the ultimate current rating of the output is limited by the thermal properties of the device package and the PCB on which the device is mounted. There is a simple, Ohm's law type relationship between thermal resistance, power dissipation and temperature which are analogous to an electrical circuit:

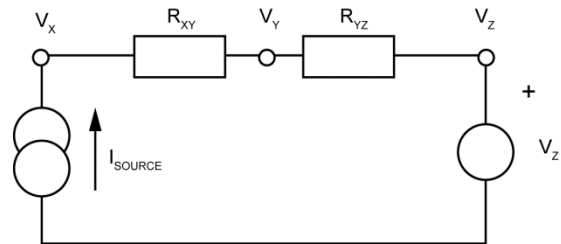

Figure 5. Series Electrical Resistance Circuit

From this simple circuit we can calculate V_x if we know I_{SOURCE} , V_z and the resistor values, R_{xy} and R_{yz} using Equation 1:

$$V_x = I_{SOURCE} \times (R_{xy} + R_{yz}) + V_z \tag{Eq. 1}$$

Thermal circuits can be considered using this same rule and can be drawn similarly by replacing current sources with power dissipation (in watts), resistance with thermal resistance (in °C/W) and voltage sources with temperature (in °C).

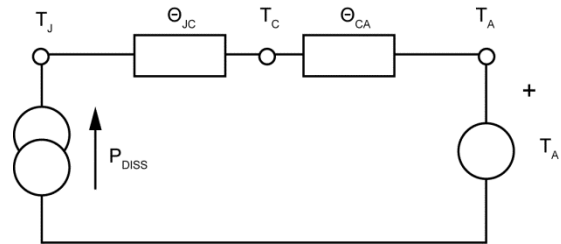

Figure 6. Series Thermal Resistance Circuit

Now replacing the variables in the equation for V_x , we can find the junction temperature (T_j) from the power dissipation, ambient temperature and the known thermal resistance of the PCB (θ_{CA}) and the package (θ_{JC}).

$$T_J = P_{DISS} \times (\theta_{JC} + \theta_{CA}) + T_A \tag{Eq. 2}$$

As can be seen in the diagram, total thermal resistance $\theta_{JA} = \theta_{JC} + \theta_{CA}$. Hence this can also be written as in Equation 3:

$$T_J = P_{DISS} \times (\theta_{JA}) + T_A \tag{Eq. 3}$$

Since effectively all of the power losses (minus the inductor losses) in the converter are dissipated within the MIC2874 package, P_{DISS} can be calculated thus:

Linear Mode:

$$P_{DISS} = [P_{OUT} \times \left(\frac{1}{\eta} - 1\right)] - I_{OUT}^2 \times DCR \tag{Eq. 4}$$

Boost Mode:

$$P_{DISS} = [P_{OUT} \times \left(\frac{1}{\eta} - 1\right)] - \left(\frac{I_{OUT}}{1-D}\right)^2 \times DCR \tag{Eq. 5}$$

Duty Cycle in Boost Mode:

$$D = \frac{V_{OUT} - V_{IN}}{V_{OUT}} \tag{Eq. 6}$$

where:

η = Efficiency taken from efficiency curves and DCR = inductor DCR. θ_{JC} and θ_{JA} are found in the operating ratings section of the data sheet.

Where the real board area differs from 1 inch square, θ_{CA} (the PCB thermal resistance) values for various PCB copper areas can be taken from Figure 7. Figure 7 is taken from *Designing with Low Dropout Voltage Regulators* available from the Micrel website (“LDO Application Hints”).

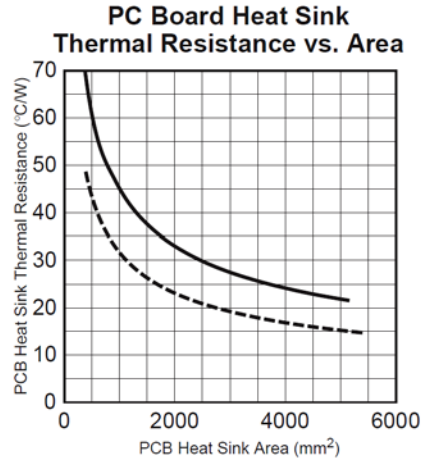

Figure 7. Graph to Determine PC Board Area for a Given PCB Thermal Resistance

Figure 7 shows the total area of a round or square pad, centered on the device. The solid trace represents the area of a square, single sided, in horizontal orientation, solder masked, copper PC board trace heat sink, measured in square millimeters. No airflow is assumed. The dashed line shows PC boards trace heat sink covered in black oil-based paint and with 1.3m/sec (250 feet per minute) airflow. This approaches a “best case” pad heat sink. Conservative design dictates using the solid trace data, which indicates that a maximum pad size of 5000 mm² is needed. This is a pad 71mm by 71mm (2.8 inches per side).

PCB Layout Guidelines

PCB layout is critical to achieve reliable, stable and efficient performance. A ground plane is required to control EMI and minimize the inductance in power, signal and return paths. The following guidelines should be followed to ensure proper operation of the device:

IC (Integrated Circuit)

- Place the IC close to the point-of-load (in this case, the flash LED).
- Use fat traces to route the input and output power lines.
- Analog grounds (LGND and AGND) and power ground (PGND) should be kept separate and connected at a single location.
- 6 to 12 thermal vias must be placed on the PCB top layer PGND copper from the PGND pin and connected it to the ground plane to ensure a good PCB thermal resistance can be achieved.
- Since all the top copper areas connected directly to the CSP package bumps are used as the immediate PCB heat sink, these top copper areas should be spread out from the bumps in funnel-shape to maximize the top copper PCB heat sink areas.

VIN Decoupling Capacitor

- The VIN decoupling capacitor must be placed close to the VIN pin of the IC and preferably connected directly to the pin and not through any via. The capacitor must be located right at the IC.
- The VIN decoupling capacitor should be connected to analog ground (AGND).
- The VIN terminal is noise sensitive and the placement of capacitor is very critical.

Inductor

- Keep both the inductor connections to the switch node (SW) and input power line short and wide enough to handle the switching current. Keep the areas of the switching current loops small to minimize the EMI problem.
- Do not route any digital lines underneath or close to the inductor.
- Keep the switch node (SW) away from the noise sensitive pins.
- To minimize noise, place a ground plane underneath the inductor.

Output Capacitor

- The output capacitor must be placed close to the OUT pin and PGND pin of the IC and preferably connected directly and closely to the OUT pin and PGND pin without going through any via to minimize the switching current loop during the main switch off-cycle, and the switching noise.
- Use wide and short traces to connect the output capacitor to the OUT and PGND pins.
- Place several vias to the ground plane close to the output capacitor ground terminal.
- Use either X5R or X7R temperature rating ceramic capacitors. Do not use Y5V or Z5U type ceramic capacitors.

Flash LED

- Use wide and short trace to connect the LED anode to the OUT pin.
- Use wide and short trace to connect the LED cathode to the LED pin.
- Make sure that the LED's PCB land pattern can provide sufficient PCB pad heat sink to the flash LED, such as sufficient copper areas and thermal vias.

Typical Application Schematic

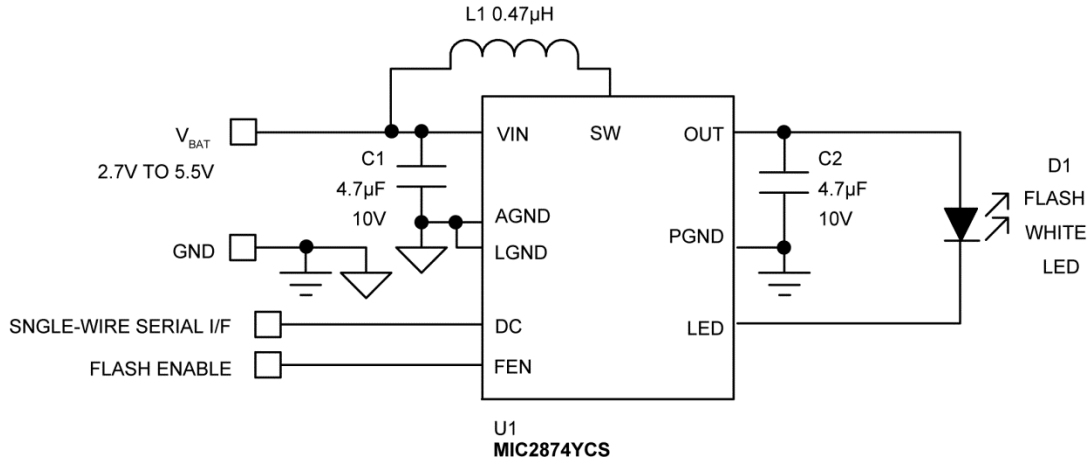

Bill of Materials

Item	Part Number	Manufacturer	Description	Qty.
C1, C2	C1608X5R1A475K080AC	TDK ⁽⁷⁾	Capacitor 4.7 µF, 10V, 10%, X5R, 0603	2
D1	SPFCW04301BL	Samsung ⁽⁸⁾	High-Power Flash LED, 4.1mm x 3.9mm x 2.1mm, 220lux @ I _{LED} = 1A	1
	LXCL-MN06-3002	Philips ⁽⁹⁾	LUXEON Flash 6 Module, 4mm x 4mm x 2.2mm, 180lux @ I _{LED} = 1A	
L1	PIFE20161B-R47MS-39	Cyntec ⁽¹⁰⁾	Inductor 0.47µH, 3.9A, 2.0mm x 1.6mm x 1.2mm	1
U1	MIC2874YCS	Micrel, Inc.⁽¹¹⁾	1.2A High-Brightness Flash LED Driver with Single-Wire Serial Interface	1

Notes:

7. TDK: www.tdk.com.
8. Samsung: www.samsung.com.
9. Philips: www.philipsluminleds.com.
10. Cyntec: www.cyntec.com.
11. Micrel, Inc.: www.micrel.com.

Package Information and Recommended Landing Pattern^(12, 13)

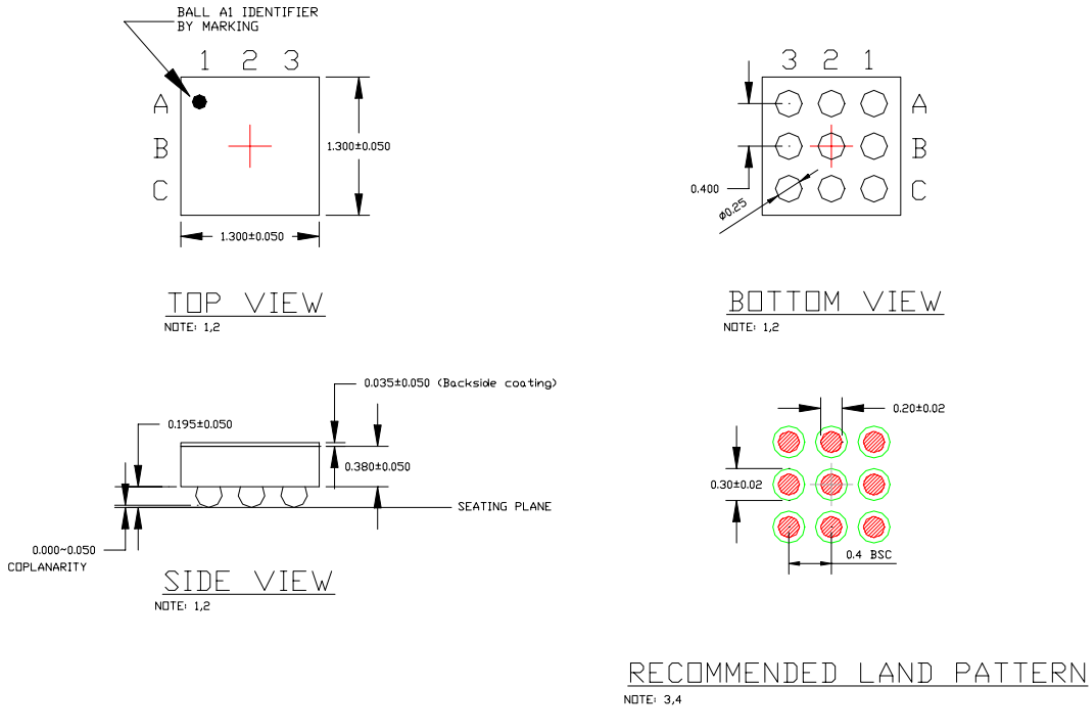

- NOTE:
1. MAX PACKAGE WARPAGE IS 0.05 MM
 2. MAX ALLOWABLE BURR IS 0.076MM IN ALL DIRECTIONS
 3. NON-SOLDERMASK DEFINED PADS ARE RECOMMENDED FOR BOARD LAYOUT
 4. SHADED RED CIRCLES REPRESENT CONTACT PAD AREA. GREEN CIRCLES REPRESENT SOLDER MASK OPENING

9-Bump 1.3mm x 1.3mm WLCSP (CS)

Notes:

12. Package information is correct as of the publication date. For updates and most current information, go to www.micrel.com.
13. Disclaimer: This is only a recommendation based on information available to Micrel from its suppliers. Actual land pattern may have to be significantly different due to various materials and processes used in PCB assembly. Micrel makes no representation or warranty of performance based on the recommended land pattern.

MICREL, INC. 2180 FORTUNE DRIVE SAN JOSE, CA 95131 USA
 TEL +1 (408) 944-0800 FAX +1 (408) 474-1000 WEB <http://www.micrel.com>

Micrel makes no representations or warranties with respect to the accuracy or completeness of the information furnished in this data sheet. This information is not intended as a warranty and Micrel does not assume responsibility for its use. Micrel reserves the right to change circuitry, specifications and descriptions at any time without notice. No license, whether express, implied, arising by estoppel or otherwise, to any intellectual property rights is granted by this document. Except as provided in Micrel's terms and conditions of sale for such products, Micrel assumes no liability whatsoever, and Micrel disclaims any express or implied warranty relating to the sale and/or use of Micrel products including liability or warranties relating to fitness for a particular purpose, merchantability, or infringement of any patent, copyright or other intellectual property right.

Micrel Products are not designed or authorized for use as components in life support appliances, devices or systems where malfunction of a product can reasonably be expected to result in personal injury. Life support devices or systems are devices or systems that (a) are intended for surgical implant into the body or (b) support or sustain life, and whose failure to perform can be reasonably expected to result in a significant injury to the user. A Purchaser's use or sale of Micrel Products for use in life support appliances, devices or systems is a Purchaser's own risk and Purchaser agrees to fully indemnify Micrel for any damages resulting from such use or sale.

© 2014 Micrel, Incorporated.