

THIS DRAWING IS UNPUBLISHED. RELEASED FOR PUBLICATION
 © COPYRIGHT BY TYCO ELECTRONICS CORPORATION. ALL RIGHTS RESERVED.

LOC	DIST	REVISIONS					
G	86	P	LTR	DESCRIPTION	DATE	DWN	APVD
			E1	REVISED PER ECR 07-018343	06AUG07	JR	TM

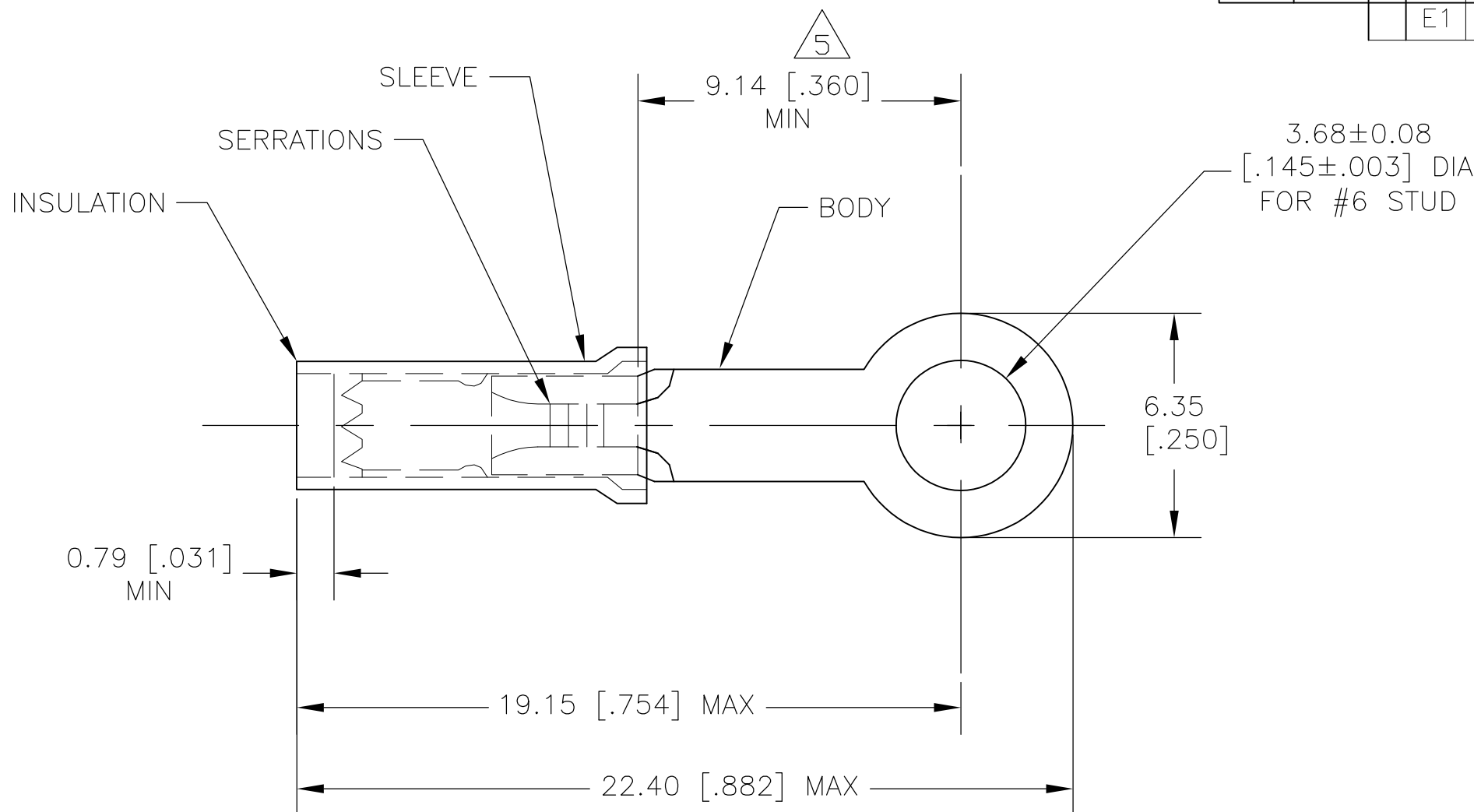

- 1 BODY - COPPER PER ASTM B152 ANNEALED
SLEEVE - COPPER PER ASTM B152
INSULATION - NYLON
- 2 BODY & SLEEVE - TIN PLATED
INSULATION - COLOR - PURPLE
- 3 FOR 1.14-2.03 [.045-.080] DIA WIRE INSULATION
- 4 STAMP AMP 20, APPROX WHERE SHOWN.
- 5 APPLIES FROM EDGE OF METAL WIRE BARREL TO CENTERLINE OF STUD HOLE.
- 6 0.41-0.65mm² [810-1,290] CMA SOLID OR STRANDED

1000	LOOSE PIECE	152896
QTY	PACKAGING TYPE	PART NO.

THIS DRAWING IS A CONTROLLED DOCUMENT.		DWN jr_ruth 06AUG07	Tyco Electronics Corporation Harrisburg, PA 17105-3608	
DIMENSIONS: MM [INCHES]		CHK T MICHELUTTI 30AUG07	NAME RING TONGUE, PIDG	
TOLERANCES UNLESS OTHERWISE SPECIFIED:		APVD T MICHELUTTI 30AUG07	PRODUCT SPEC -	
0 PLC ± - 1 PLC ± - 2 PLC ± - 3 PLC ± 0.38 [.015] 4 PLC ± - ANGLES ± 5°		APPLICATION SPEC -		
MATERIAL - 1	FINISH - 2	SIZE A3	CAGE CODE 00779	DRAWING NO C-152896
CUSTOMER DRAWING			RESTRICTED TO -	SCALE 6:1
			SHEET 1 OF 1	REV E1