



**Pb-free  
HEAT**



## **NORG141 Series**

Numeric Display/  
Bi-Color Type/Case Size 10.0 x 19.0 mm

### Features

Case Size	10.0 x 19.0 mm (W x H)
Product features	<ul style="list-style-type: none"> <li>▪ Bi-Color</li> <li>▪ Each color has anode common and cathode common respectively.</li> <li>▪ A black case and a gray case are available.</li> <li>▪ Lead-free soldering compatible</li> <li>▪ RoHS compliant</li> </ul>
Peak wavelength	Green : 570nm Red : 660nm
Number of Digit	1 Digit
Segment Shape	Arrow Feather Type
Character Height	10 mm
Die materials	Green : GaP Red : GaAlAs
Soldering methods	TTW (Through The Wave) soldering and manual soldering
ESD	More than 2kV(HBM)
Packing	Tray

### Recommended Applications

Amusement Equipment, Electric Household Appliances, Other General Applications



## NORG141 Series

Numeric Display/  
Bi-Color Type/Case Size 10.0 x 19.0 mm

### Emitted Color

Part No.		Material	Emitted Color	Chip/ Segment
Anode Common	Cathode Common			
Case Color Black	Case Color Black			
NARG141	NKRG141	GaP	Green	1
		GaAsP	Red	1

### Absolute Maximum Ratings

(Ta=25 )

Item	Symbol	Absolute Maximum Ratings		Unit
		Green	Red	
Power Dissipation <sup>※1</sup>	Pd	36	36	mW/seg
Forward Current <sup>※1</sup>	I <sub>F</sub>	15	15	mA/seg
Pulse Forward Current <sup>※1,※2</sup>	I <sub>FRM</sub>	70	70	mA/seg
Derating (Ta=25°C or higher)	ΔI <sub>F</sub>	0.22	0.22	mA/°C
	ΔI <sub>FRM</sub>	1.00	1.00	mA/°C
Reverse Voltage	V <sub>R</sub>	4	4	V
Operating Temperature	T <sub>opr</sub>	-30~+70	-30~+70	°C
Storage Temperature	T <sub>stg</sub>	-30~+80	-30~+80	°C

※1 When bi-color LEDs are driven simultaneously, the above ratings is the total of Pd, I<sub>F</sub> and I<sub>FRM</sub> values.

※2 I<sub>FRM</sub> Measurement condition : Duty 1/5, f = 1kHz

### Electro-Optical Characteristics

(Ta=25 )

Item	Conditions	Symbol	Characteristics		Unit
			Green	Red	
Luminous Intensity	I <sub>F</sub> =10mA	I <sub>v</sub>	MIN.	1.2	1.2
			TYP.	2.4	2.4
Forward Voltage	I <sub>F</sub> =10mA	V <sub>F</sub>	TYP.	2.0	1.7
			MAX.	2.4	2.0
Reverse Current	V <sub>R</sub> =4V	I <sub>R</sub>	MAX.	20	20
Peak Wavelength	I <sub>F</sub> =10mA	λ <sub>p</sub>	TYP.	570	660
Spectral Line Half Width	I <sub>F</sub> =10mA	Δλ	TYP.	30	30

## Technical Data

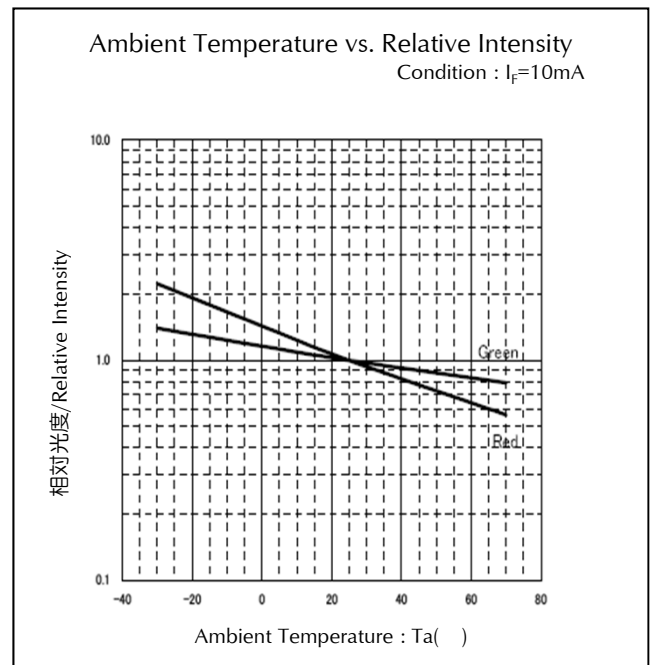
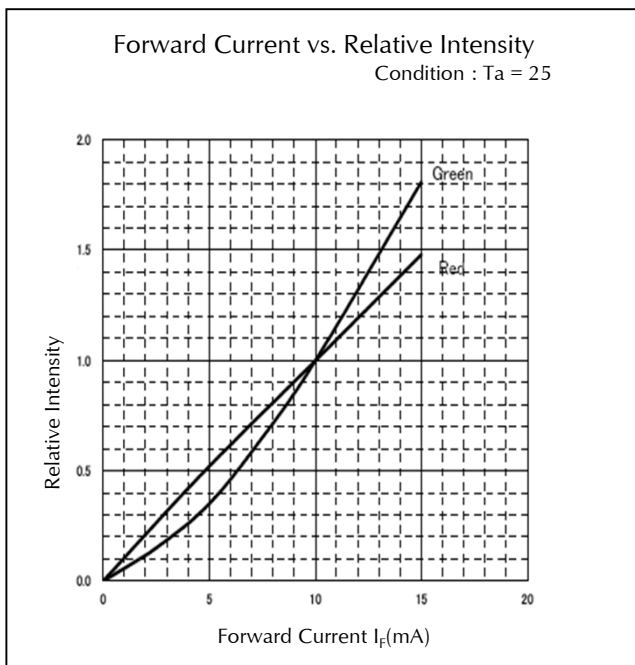
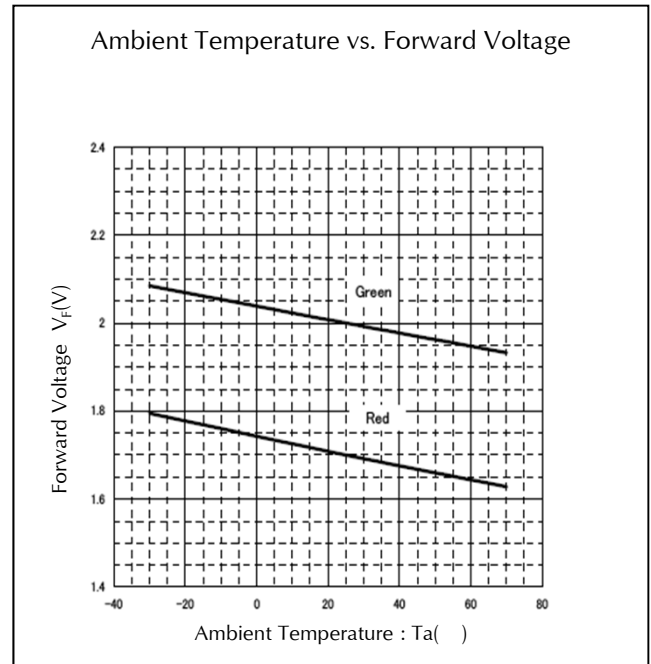
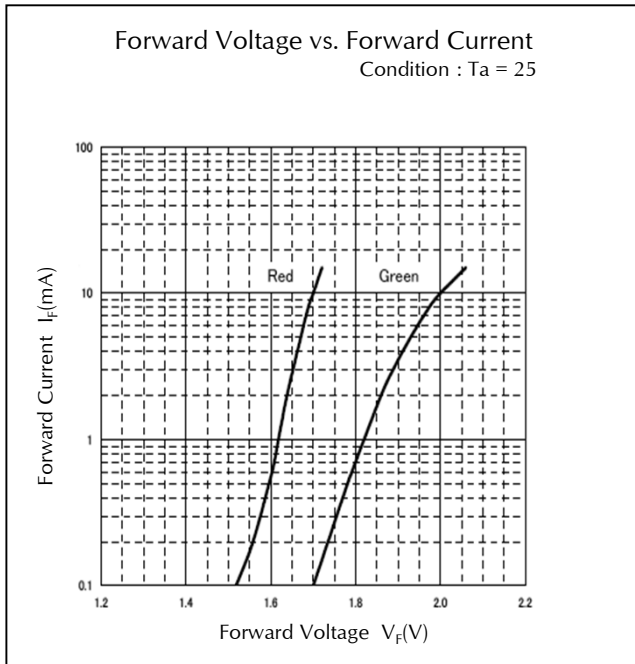

## Technical Data

Ambient Temperature vs. Maximum Forward Current

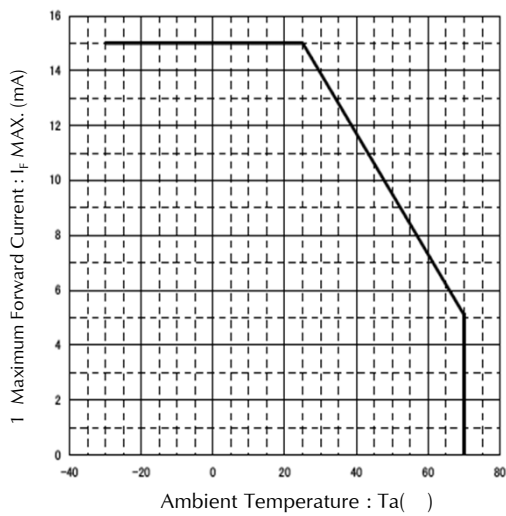

Ambient Temperature vs. Power Dissipation

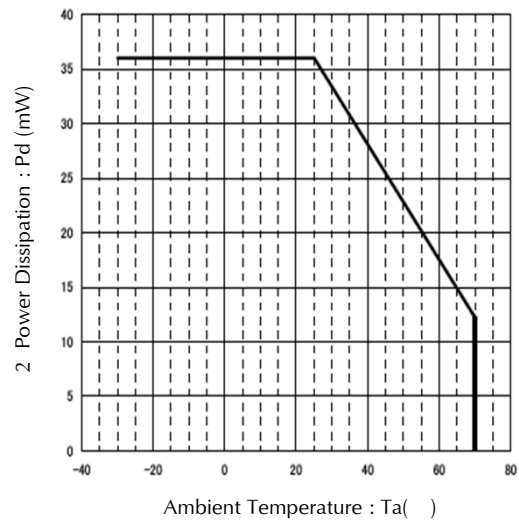

Duty Factor vs. Maximum Tolerable Pulse Forward Current  
Condition : Ta = 25

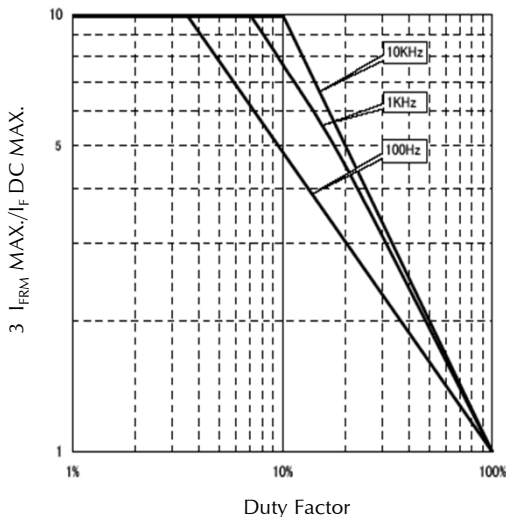

### Notes

1, 2, 3  
When bi-color LEDs are driven simultaneously, the ratings of these description graphs is the total of I<sub>F</sub> Max., Pd and I<sub>FRM</sub> Max./I<sub>F</sub> DC MAX. values.

Package Dimensions

(Unit: mm)

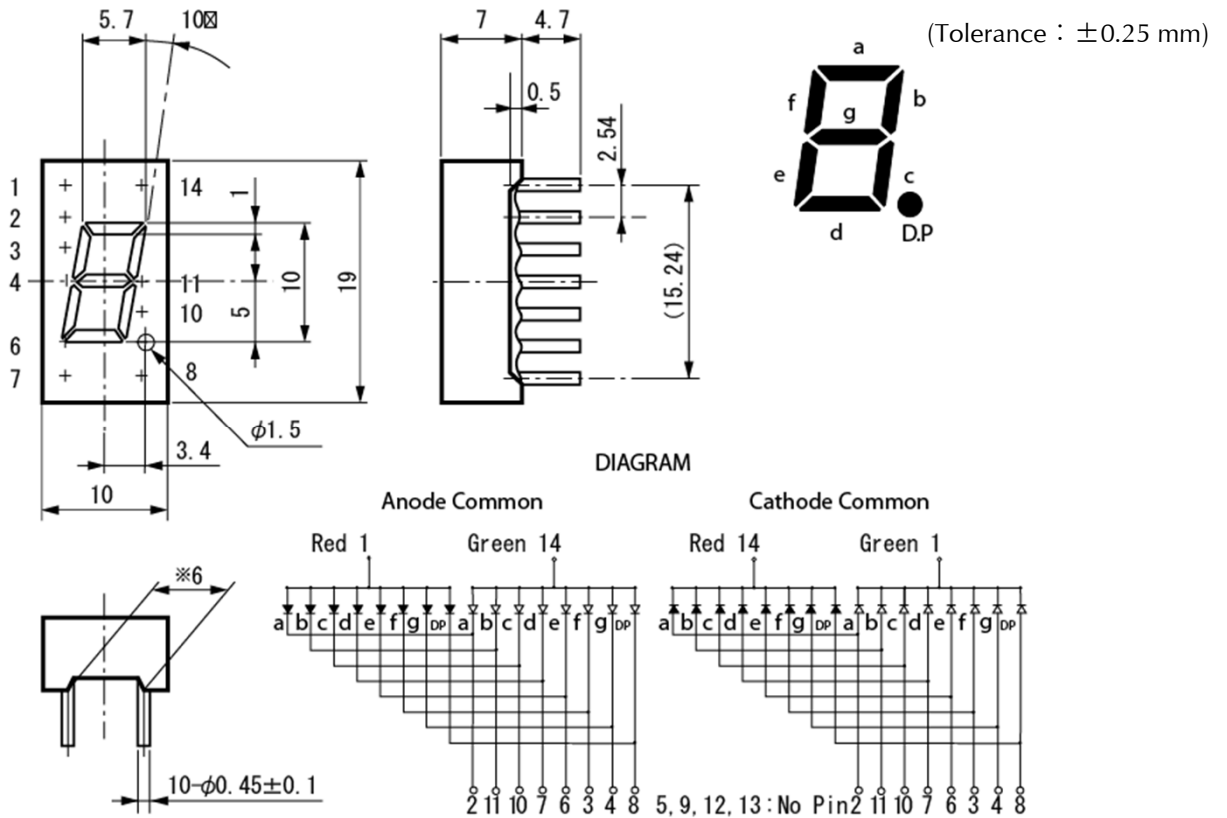

The length of lead base.

Recommended Soldering Pattern

(Unit: mm)

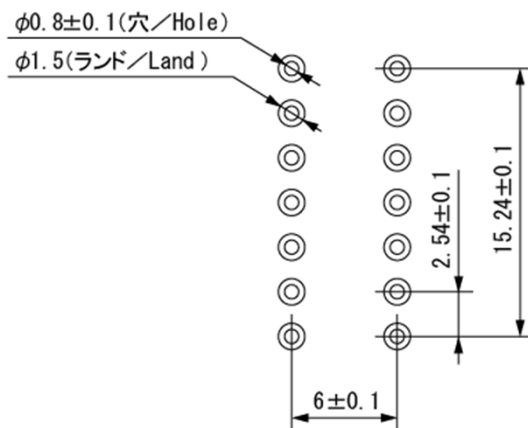

## TTW (Through The Wave) soldering Conditions

---

Pre-heating	100 60 s	(MAX.) Resin surface temperature (MAX.)
Solder Bath Temp.	265	(MAX.)
Dipping Time	5 s	(MAX.)
Position	At least 2.0 mm away from the root of lead	

- 1) The dip soldering process shall be 2 times maximum.
- 2) The product shall be cooled to normal temperature before the second dipping process.

## Manual Soldering Conditions

---

Iron tip temp.	360	(MAX.)
Soldering time and frequency	3 s 2 times	(MAX.) (MAX.)
Position	At least 2.0 mm away from the root of lead	

## Reliability Testing Result

Reliability Testing Result	Applicable Standard	Testing Conditions	Duration	Failure
Room Temp. Operating Life	EIAJ ED-4701/100(101)	Ta = 25°C, If = Maximum Rated Current/seg	1,000 h	0/10
Resistance to Soldering Heat	EIAJ ED-4701/300(302)	260±5°C, 3mm from package base	10s	0/10
Temperature Cycling	EIAJ ED-4701/100(105)	Minimum Rated Storage Temperature(30min) ~Normal Temperature(15min) ~Maximum Rated Storage Temperature(30min) ~Normal Temperature(15min)	5 cycles	0/10
Wet High Temp. Storage Life	EIAJ ED-4701/100(103)	Ta = 60±2°C, RH = 90±5%	1,000 h	0/10
High Temp. Storage Life	EIAJ ED-4701/200(201)	Ta = Maximum Rated Storage Temperature	1,000 h	0/10
Low Temp. Storage Life	EIAJ ED-4701/200(202)	Ta = Minimum Rated Storage Temperature	1,000 h	0/10
Lead Tension	EIAJ ED-4701/400(401)	5N, 1time	10s	0/10
Vibration, Variable Frequency	EIAJ ED-4701/400(403)	98.1m/s <sup>2</sup> (10G), 100 ~ 2KHz sweep for 20min., XYZ each direction	2 h	0/10
Lead Bend	EIAJ ED-4701/400(401)	2.5N, 0° ↔ 90°	Twice	0/10
Shock	JIS C 7201 A-8	It falls on wood engraving from height of 75cm.	3 times	0/10

## Failure Criteria

Items	Symbols	Conditions	Failure criteria
Luminous Intensity	Iv	If Value of each product Luminous Intensity	Testing Min. Value < Spec. Min. Value x 0.5
Forward Voltage	V <sub>F</sub>	If Value of each product Forward Voltage	Testing Max. Value ≥ Spec. Max. Value x 1.2
Reverse Current	I <sub>R</sub>	V <sub>R</sub> = Maximum Rated Reverse Voltage V	Testing Max. Value ≥ Spec. Max. Value x 2.5
Cosmetic Appearance	-	-	Occurrence of notable decoloration, deformation and cracking

## Special Notice to Customers Using the Products and Technical Information Shown in This Data Sheet

- 1) The technical information shown in the data sheets are limited to the typical characteristics and circuit examples of the referenced products. It does not constitute the warranting of industrial property nor the granting of any license.
- 2) For the purpose of product improvement, the specifications, characteristics and technical data described in the data sheets are subject to change without prior notice. Therefore it is recommended that the most updated specifications be used in your design.
- 3) When using the products described in the data sheets, please adhere to the maximum ratings for operating voltage, heat dissipation characteristics, and other precautions for use. We are not responsible for any damage which may occur if these specifications are exceeded.
- 4) The products that have been described to this catalog are manufactured so that they will be used for the electrical instrument of the benchmark (OA equipment, telecommunications equipment, AV machine, home appliance and measuring instrument).  
The application of aircrafts, space borne application, transportation equipment, medical equipment and nuclear power control equipment, etc. needs a high reliability and safety, and the breakdown and the wrong operation might influence the life or the human body. Please consult us beforehand if you plan to use our product for the usages of aircrafts, space borne application, transportation equipment, medical equipment and nuclear power control equipment, etc. except OA equipment, telecommunications equipment, AV machine, home appliance and measuring instrument.
- 5) In order to export the products or technologies described in this data sheet which are under the "Foreign Exchange and Foreign Trade Control Law," it is necessary to first obtain an export permit from the Japanese government.
- 6) No part of this data sheet may be reprinted or reproduced without prior written permission from Stanley Electric Co., Ltd.
- 7) The most updated edition of this data sheet can be obtained from the address below:  
<http://www.stanley-components.com>