

Printed-circuit board connector - DMC 0,5/ 7-G1-2,54 P20THR R44 - 1844772

Please be informed that the data shown in this PDF Document is generated from our Online Catalog. Please find the complete data in the user's documentation. Our General Terms of Use for Downloads are valid (<http://phoenixcontact.com/download>)

Header, Nominal current: 6 A, Rated voltage (III/2): 160 V, Number of positions: 7, Pitch: 2.54 mm, Color: black, Contact surface: Gold, Mounting: THR soldering, Sample values available under SAMPLE DMC...



The figure shows a 10-pos. version with 20 contacts

Why buy this product

- Gold-plated contacts ensure transfer quality remains stable over the long term
- Designed for integration into the SMT process
- Conductor connection on several levels enables higher contact density

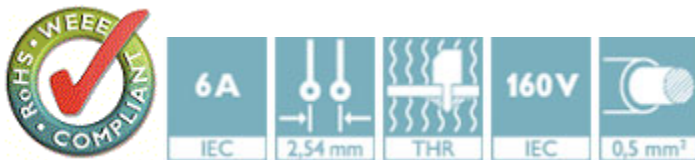

Key Commercial Data

Packing unit	1 STK
Minimum order quantity	300 STK
Custom tariff number	85366990
Country of origin	Germany

Technical data

Environmental Product Compliance

China RoHS	No hazardous substances above threshold values
------------	--

Dimensions

Length	9.64 mm
Pitch	2.54 mm
Dimension a	15.24 mm
Width	18.28 mm

Printed-circuit board connector - DMC 0,5/ 7-G1-2,54 P20THR R44 - 1844772

Technical data

Dimensions

Height	7.39 mm
Length of the solder pin	2 mm
Pin dimensions	0,64 x 0,64 mm
Pin spacing	2.54 mm
Hole diameter	1.2 mm

General

Range of articles	DMC 0,5/...G1-THR
Insulating material group	IIIa
Rated surge voltage (III/3)	2.5 kV
Rated surge voltage (III/2)	2.5 kV
Rated surge voltage (II/2)	2.5 kV
Rated voltage (III/3)	32 V
Rated voltage (III/2)	160 V
Rated voltage (II/2)	160 V
Connection in acc. with standard	EN-VDE
Nominal current I_N	6 A
Insulating material	LCP
Flammability rating according to UL 94	V0
Color	black
Number of positions	7

Standards and Regulations

Connection in acc. with standard	EN-VDE
Flammability rating according to UL 94	V0

Drawings

Printed-circuit board connector - DMC 0,5/ 7-G1-2,54 P20THR R44 - 1844772

Drilling diagram

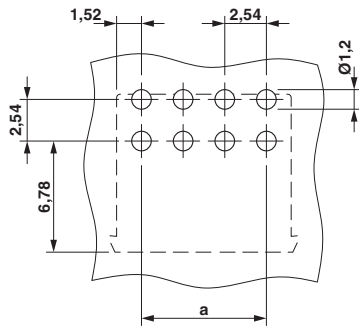

Diagram

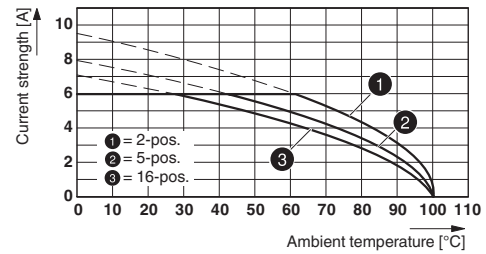

Type: DFMC 0,5/...-ST-2,54 with DMC 0,5/...-G1-2,54 P20THR R...

Dimensional drawing

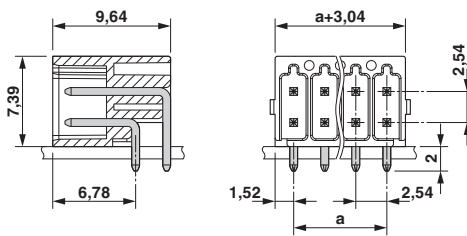

Classifications

eCl@ss

eCl@ss 5.1	27260701
eCl@ss 6.0	27260704
eCl@ss 8.0	27440402
eCl@ss 9.0	27440402

ETIM

ETIM 4.0	EC002637
ETIM 5.0	EC002637

Approvals

Approvals

Approvals

cULus Recognized / VDE Gutachten mit Fertigungsüberwachung / IEC60320 CB Scheme / EAC

Printed-circuit board connector - DMC 0,5/ 7-G1-2,54 P20THR R44 - 1844772

Approvals

Ex Approvals

Approval details

cULus Recognized http://database.ul.com/cgi-bin/XYV/template/LISEXT/1FRAME/index.htm E60425-19920306		
	B	C
Nominal current I _N	6 A	6 A
Nominal voltage U _N	150 V	50 V

VDE Gutachten mit Fertigungsüberwachung  http://www.vde.de 40042389	
Nominal current I _N	6 A
Nominal voltage U _N	160 V

IECEE CB Scheme  http://www.iecee.org/ DE1-55740	
Nominal current I _N	6 A
Nominal voltage U _N	160 V

EAC B.01742

Accessories

Accessories

Labeled terminal marker

Marker card - SK 2,54/2,8:FORTL.ZAHLEN - 0804853



Marker card, Card, white, labeled, Horizontal: Consecutive numbers 1 - 10, 11 - 20, etc. up to 91 - 99, Mounting type: Adhesive, for terminal block width: 2.54 mm, Lettering field: 2.54 x 2.8 mm

Printed-circuit board connector - DMC 0,5/ 7-G1-2,54 P20THR R44 - 1844772

Accessories

Sample set - SAMPLE DMC 0,5/ 7-G1-2,54 THR - 1859547



Header, Nominal current: 6 A, Rated voltage (III/2): 160 V, Number of positions: 7, Pitch: 2.54 mm, Color: black, Contact surface: Gold, Mounting: THR soldering

Additional products

Printed-circuit board connector - DFMC 0,5/ 7-ST-2,54 - 1844620



Plug, nominal current: 6 A, rated voltage (III/2): 160 V, number of positions: 7 with 14 contacts, pitch: 2.54 mm, connection method: spring connection, color: black, contact surface: gold