

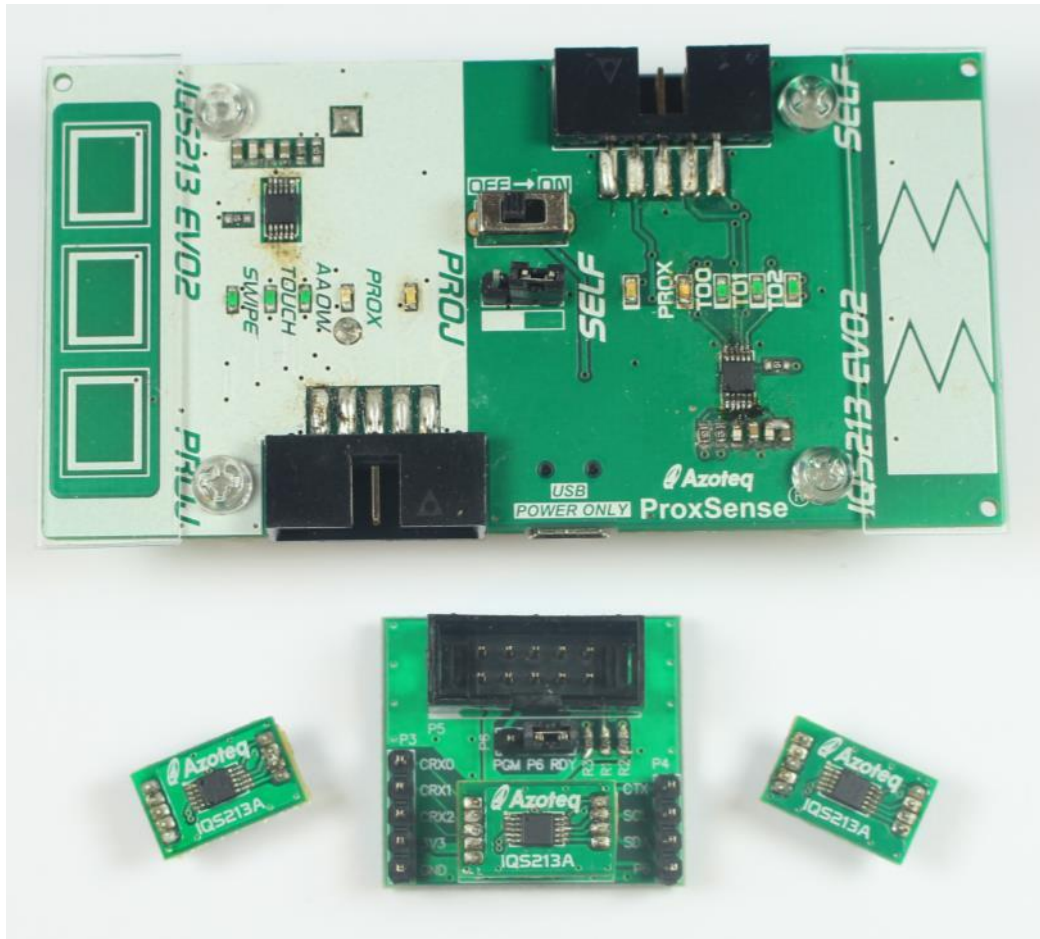

IQS213AEV02 Evaluation Kit User Guide





Contents

1	Introduction	3
2	Standalone Operation	3
2.1	Self-side operation	3
2.2	Projected-side operation	3
2.2.1	Advanced Auto-Off Warning	4
3	Data Streaming Operation	4
3.1	Self-side operation	5
3.2	Projected side operation	6
4	Prototype Board	7
4.1	Prototype Board	7
5	Communications Interface	8
6	Reference Designs	8



1 Introduction

This user guide describes the operation of the IQS213AEV02 Evaluation Kit.

The EV-Kit consists of the following parts:

- 1 x Main board
- 1 x Plug-in board
- 3 x Module boards

To visualize raw data from the EV-Kit, the main board can be interfaced to any personal computer with USB support and IQS213A software GUI (Graphical User Interface). The purpose of the IQS213AEV02 EV-Kit is to help application and development engineers in evaluating the IQS213A Proximity, Touch and Swipe sensor.

2 Standalone Operation

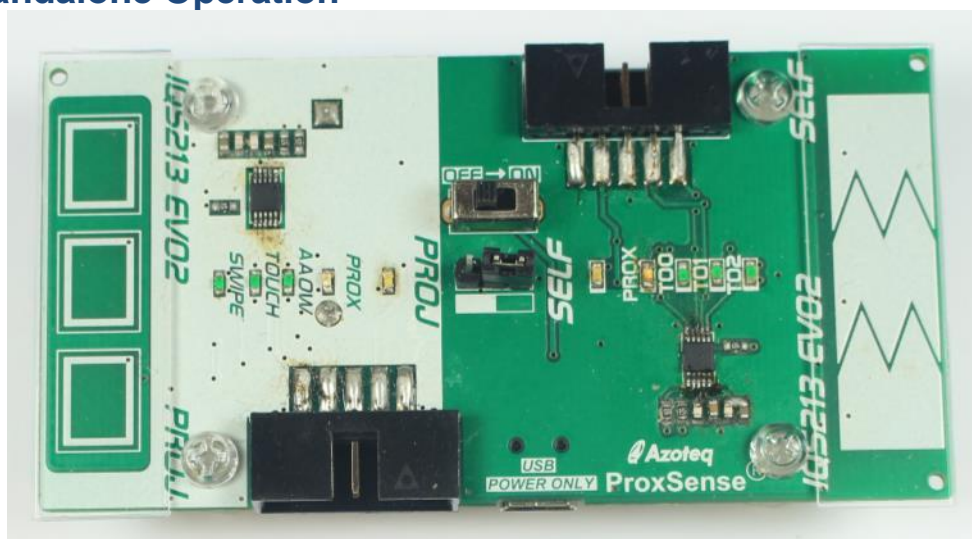

Figure 2.1 IQS213AEV02 main board

Select between the Projected and Self side with the jumper.
Move the slide switch to the ON position.

2.1 Self-side operation

Ensure the jumper is placed on the Self-side selection of the pins.
The red LED on the Self-side should turn on.
Approach the sense buttons with a finger.
When close to the sense buttons the blue Prox LED will turn on.
Touch the sense buttons and the corresponding green Touch LED will turn on.

2.2 Projected-side operation

Ensure the jumper is placed on the Proj-side selection of the pins.
The red LED on the Proj-side should turn on.
Approach the sense buttons with a finger.
When close to the sense buttons the blue Prox LED will turn on.
Perform a Swipe action across all 3 sensors. Touch on the left/right sensor and drag to the opposite side.
The green Swipe LED should turn on (if not, try to swipe faster).



With the Swipe LED on, the green Touch LED will show touches on any of the 3 buttons. The Advanced Auto-Off Warning (AAOW) green LED could show false activation and disable all outputs.

2.2.1 Advanced Auto-Off Warning

In standalone operation the Advanced Auto-Off Warning (AAOW) timer is set to 10 minutes. When the timer reaches this a warning is given. 30 seconds after this a second warning will be given. 30 seconds after the second warning the device will switch off automatically (disable all outputs). (Thus after 11 minutes the device will switch off).

This timer is default set to clear on a touch event on any button. When communicating with the IQS213A this timer can be set to clear on a Prox event or disabled entirely.

3 Data Streaming Operation

Connect the CT210 or DS100 to the Self/Proj side of the IQS213AEV02 EV-Kit.

The IQS213A GUI looks as follow:

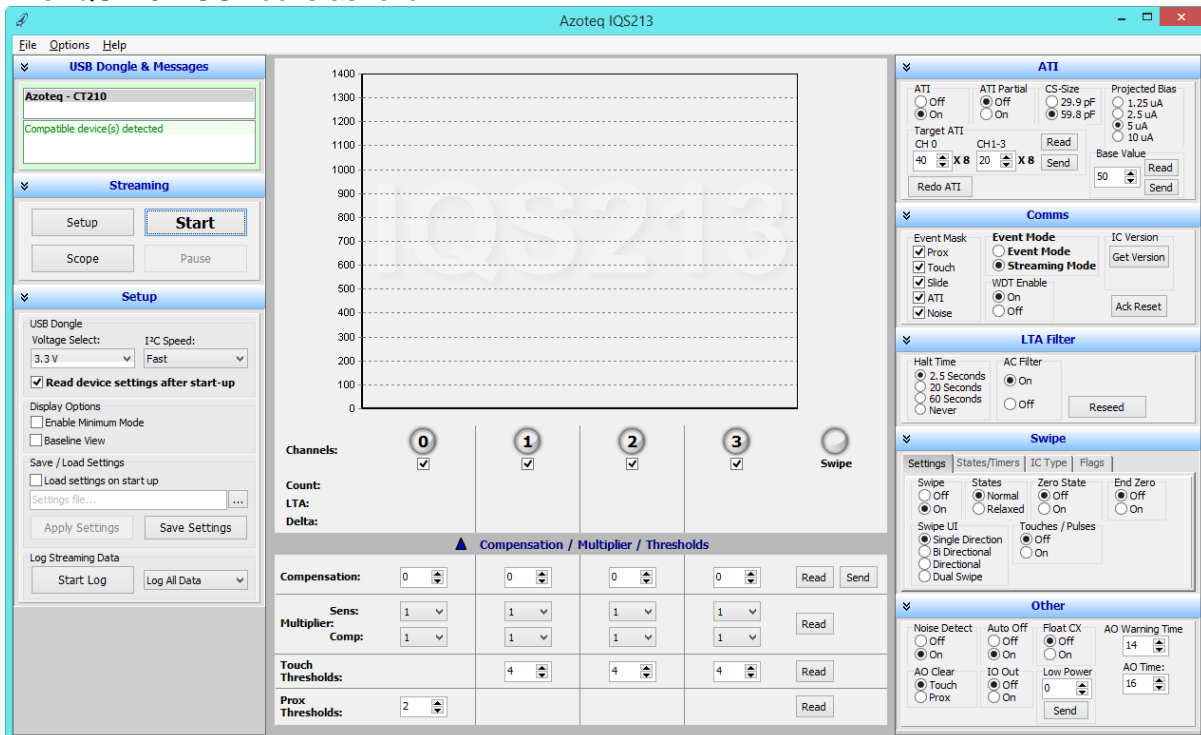

Figure 3.1 IQS213 GUI

This is version V1.0.0.140 available from the Azoteq website. Click [here](#) to go to the GUI download page. Install and run the software.

Connect the CT210/DS100 to the PC with a USB cable.

Connect the IQS213AEV02 EV-Kit to the CT210/DS100 with a ribbon cable.



3.1 Self-side operation

Connect the ribbon cable to the IQS213AEV02 EV-Kit at the Self-side.
In the GUI, click the Start button.

The following window should pop-up:

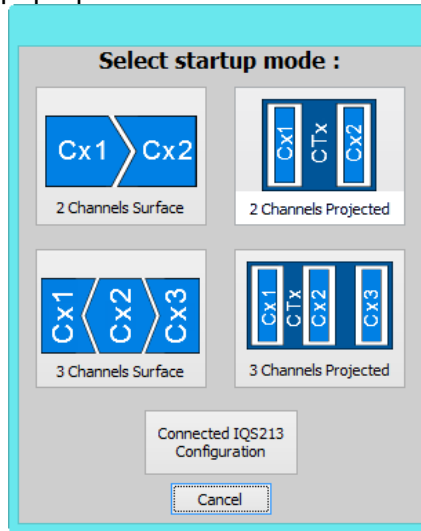

Figure 3.2 Pop-up window user selection options

For the Self-side select the “Connected IQS213 Configuration” option as the EV-Kit has been designed for this selection and the IC has the suggested settings on it.

The Self-side data streaming is show below.

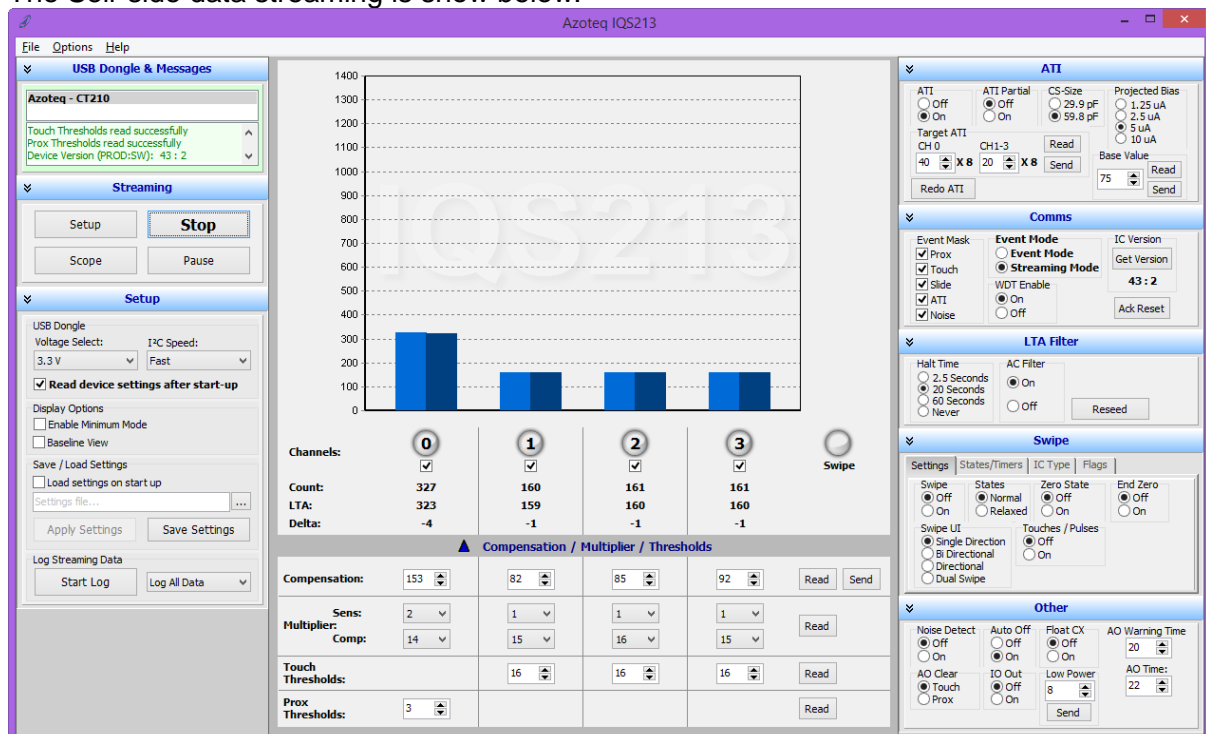

Figure 3.3 GUI with Self Capacitance selected

Evaluate this setup while streaming the data to the GUI. Various options on the right side of the GUI can be chosen to further evaluate the capabilities and features of this IC.



3.2 Projected side operation

Connect the ribbon cable to the IQS213AEV02 EV-Kit at the Proj (Projected)-side. In the GUI, click the Start button.

The following window should pop-up:

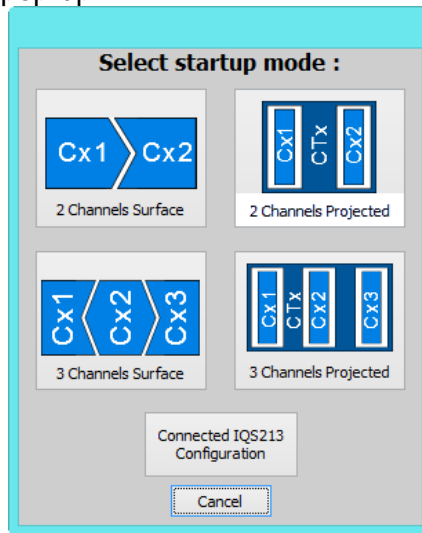

Figure 3.4 Pop-up window user selection options

For the Proj-side select the “Connected IQS213 Configuration” option as the EV-Kit has been designed for this selection and the IC has the suggested settings on it.

The Proj-side data streaming is show below.

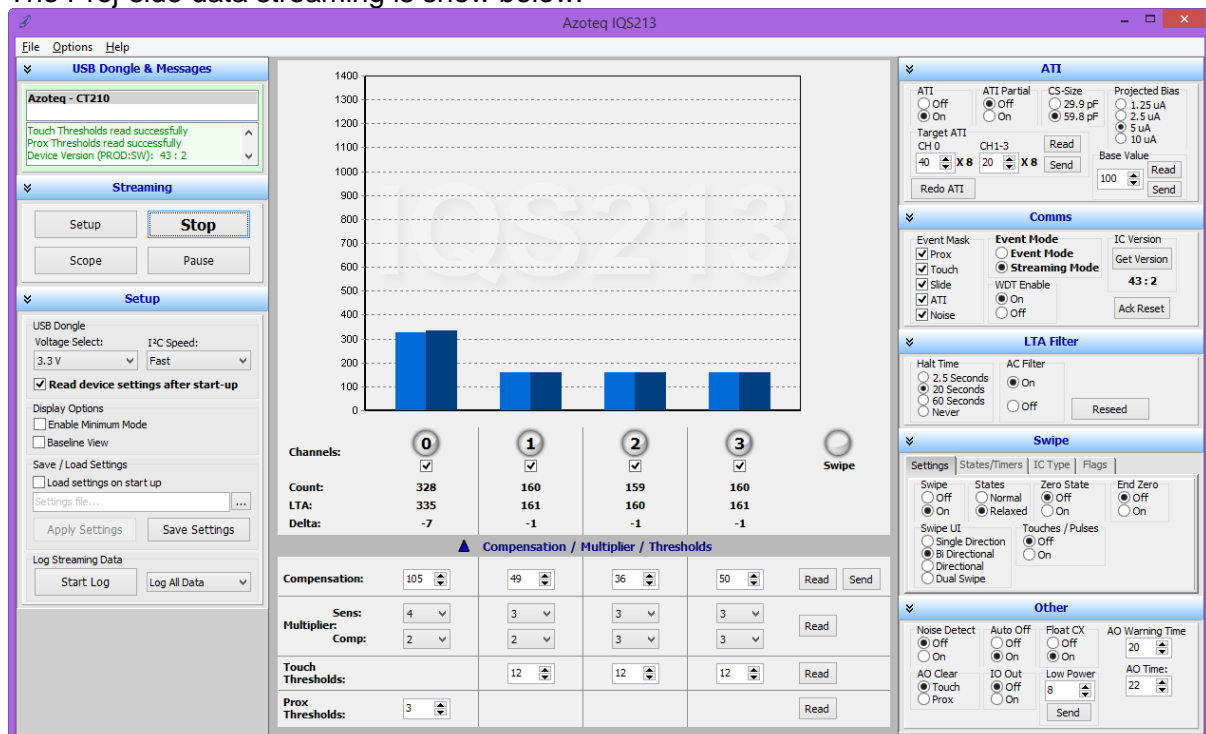

Figure 3.5 GUI with Projected Capacitance selected

Evaluate this setup while streaming the data to the GUI. Various options on the right side of the GUI can be chosen to further evaluate the capabilities and features of this IC.



4 Prototype Board

The IQS213AEV02 EV-Kit also comes with a Prototype Board and 3 x Module Boards for rapid prototyping.



Figure 4.1 Prototype Board (center) and Module Boards (left, right and plugged into center board)

This is used for rapid prototyping. Simply wire this board into your current design and evaluate the performance with the GUI.

4.1 Prototype Board

This is basically a breakout board for the module board. Plug a module board into the Prototype board and configure it with the Azoteq USBProg software program available from the Azoteq website.

Please Note: Fuse bits can only be programmed once!

Here is an example of how the USBProg software looks like.

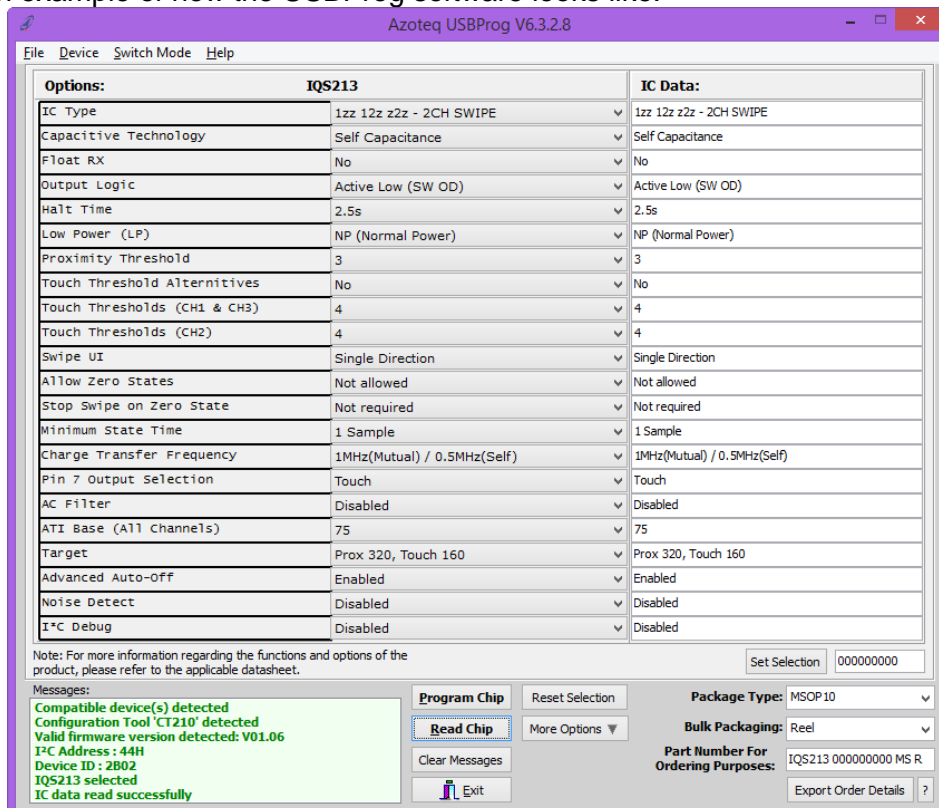

Figure 4.2 Azoteq USBProg Software



5 Communications Interface

The IQS213A IC communicates according to I²C communication protocol.

6 Reference Designs

The reference design for the main board is shown below.

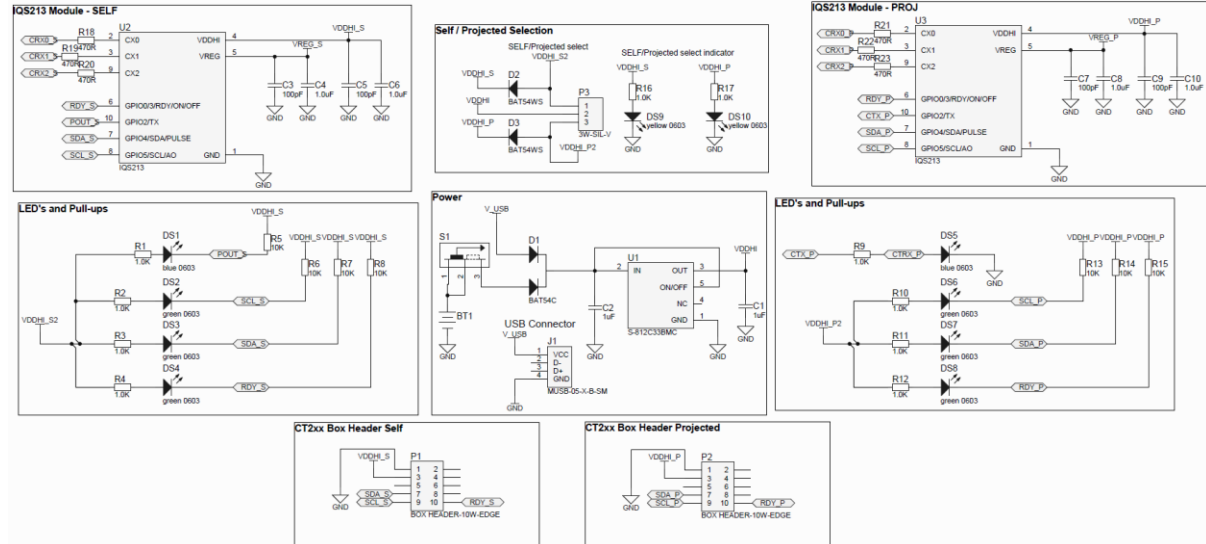

Figure 6.1 Reference design for IQS213AEV02 Main Board



Appendix A Contact Information

	USA	Asia	South Africa
Physical Address	6507 Jester Blvd Bldg 5, suite 510G Austin TX 78750 USA	Rm2125, Glittery City Shennan Rd Futian District Shenzhen, 518033 China	109 Main Street Paarl 7646 South Africa
Postal Address	6507 Jester Blvd Bldg 5, suite 510G Austin TX 78750 USA	Rm2125, Glittery City Shennan Rd Futian District Shenzhen, 518033 China	PO Box 3534 Paarl 7620 South Africa
Tel	+1 512 538 1995	+86 755 8303 5294 ext 808	+27 21 863 0033
Fax	+1 512 672 8442		+27 21 863 1512
Email	info@azoteq.com	linayu@azoteq.com.cn	info@azoteq.com

Please visit www.azoteq.com for a list of distributors and worldwide representation.

The following patents relate to the device or usage of the device: US 6,249,089 B1; US 6,621,225 B2; US 6,650,066 B2; US 6,952,084 B2; US 6,984,900 B1; US 7,084,526 B2; US 7,084,531 B2; US 7,265,494 B2; US 7,291,940 B2; US 7,329,970 B2; US 7,336,037 B2; US 7,443,101 B2; US 7,466,040 B2 ; US 7,498,749 B2; US 7,528,508 B2; US 7,755,219 B2; US 7,772,781 B2; US 7,781,980 B2; US 7,915,765 B2; US 7,994,726 B2; US 8,035,623 B2; US RE43,606 E; US 8,288,952 B2; US 8,395,395 B2; US 8,531,120 B2; US 8,659,306 B2; US 8,823,273 B2; EP 1 120 018 B2; EP 1 206 168 B1; EP 1 308 913 B1; EP 1 530 178 A1; EP 2 351 220 B1; EP 2 559 164 B1; CN 1330853; CN 1783573; AUS 761094; HK 104 1401

IQ Switch®, SwipeSwitch™, ProxSense®, LightSense™, AirButton™, ProxFusion™, Crystal Driver™ and the  logo are trademarks of Azoteq.

The information in this Datasheet is believed to be accurate at the time of publication. Azoteq uses reasonable effort to maintain the information up-to-date and accurate, but does not warrant the accuracy, completeness or reliability of the information contained herein. All content and information are provided on an "as is" basis only, without any representations or warranties, express or implied, of any kind, including representations about the suitability of these products or information for any purpose. Azoteq disclaims all warranties and conditions with regard to these products and information, including but not limited to all implied warranties and conditions of merchantability, fitness for a particular purpose, title and non-infringement of any third party intellectual property rights. Azoteq assumes no liability for any damages or injury arising from any use of the information or the product or caused by, without limitation, failure of performance, error, omission, interruption, defect, delay in operation or transmission, even if Azoteq has been advised of the possibility of such damages. The applications mentioned herein are used solely for the purpose of illustration and Azoteq makes no warranty or representation that such applications will be suitable without further modification, nor recommends the use of its products for application that may present a risk to human life due to malfunction or otherwise. Azoteq products are not authorized for use as critical components in life support devices or systems. No licenses to patents are granted, implicitly, express or implied, by estoppel or otherwise, under any intellectual property rights. In the event that any of the abovementioned limitations or exclusions does not apply, it is agreed that Azoteq's total liability for all losses, damages and causes of action (in contract, tort (including without limitation, negligence) or otherwise) will not exceed the amount already paid by the customer for the products. Azoteq reserves the right to alter its products, to make corrections, deletions, modifications, enhancements, improvements and other changes to the content and information, its products, programs and services at any time or to move or discontinue any contents, products, programs or services without prior notification. For the most up-to-date information and binding Terms and Conditions please refer to www.azoteq.com.

www.azoteq.com/ip
info@azoteq.com