

SMD ■ MID POWER LED

G62-127ET/RK7D-3MXXXXXXXXX2629U6/2T

**Features**

- PLCC-2 Package
- Top view white LED
- High luminous flux output
- High current capability
- High Efficiency
- Wide viewing angle
- Pb-free
- ANSI Binning
- ESD protection
- The product itself will remain within RoHS compliant version.
- Compliance with EU REACH.
- Compliance Halogen Free .(Br<900ppm,Cl<900ppm,Br+Cl<1500ppm)

Description

The Everlight G62-127ET package has high efficacy, high CRI, low power consumption, wide viewing angle and a compact form factor. These features make this package an ideal LED for all lighting application.

Applications

- Decorative and Entertainment Lighting
- Light pipe application
- Indicator and backlight in office and family equipment
- General use

Product Number Explanation

G62-127ET / LK X D – M XX XX XX XX XXXXU6/ 2T

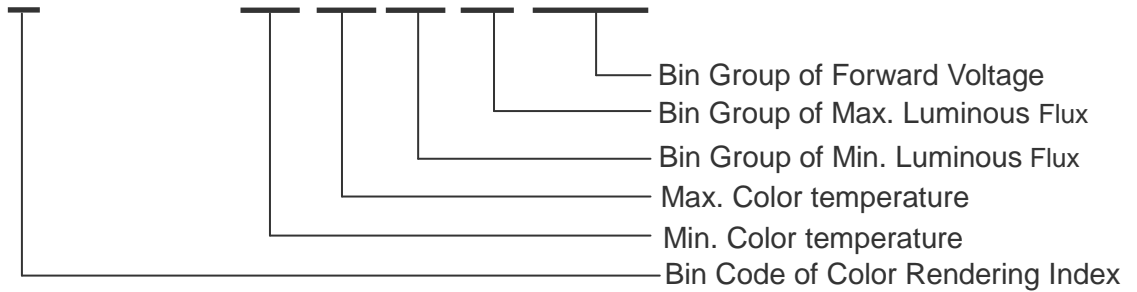

Table of Color Rendering Index

Symbol	Description
M	CRI(Min.) : 60
N	CRI(Min.) : 65
L	CRI(Min.) : 70
Q	CRI(Min.) : 75
K	CRI(Min.) : 80
H	CRI(Min.) : 90

Note:
 Tolerance of Color Rendering Index: ±2

Example:
 G62-127ET/RK7D-3M3030V7X72629U6/2T

CRI	90(Min.)
CCT	3000K
Flux	27~37lm
V _F	2.6~2.9V
I _F	65mA

Mass Production List for CRI>90

CCT(K)	Product	Flux Bin	Φ (lm) Min. (2)	Φ (lm) Typ. (2)	Series
2700K	G62-127ET/RK7D-3M2727V6X62629U6/2T	RK7D	26	28.4	-/-
3000K	G62-127ET/RK7D-3M3030V7X72629U6/2T	RK7D	27	29.5	-/-
3500K	G62-127ET/RK7D-3M3535V7X72629U6/2T	RK7D	27	29.5	-/-
4000K	G62-127ET/RK7D-3M4040V8X82629U6/2T	RK7D	28	30.6	-/-
5000K	G62-127ET/RK7D-3M5050V9X92629U6/2T	RK7D	29	31.6	-/-
5700K	G62-127ET/RK7D-3M5757V9X92629U6/2T	RK7D	29	31.6	-/-
6500K	G62-127ET/RK7D-3M6565V8X82629U6/2T	RK7D	28	30.6	-/-

Note:

1. Tolerance of Color Rendering Index: ± 2
2. Tolerance of Luminous flux: $\pm 11\%$.

EVERLIGHT

Device Selection Guide

Chip Materials	Emitted Color	Resin Color
InGaN	Warm White Neutral White Cool White	Water Clear

Absolute Maximum Ratings (T_{Soldering}=25°C)

Parameter	Symbol	Rating	Unit
Forward Current	I _F	180	mA
Peak Forward Current (Duty 1/10 @10ms)	I _{FP}	300	mA
Power Dissipation	P _d	580	mW
Operating Temperature	T _{opr}	-40 ~ +85	°C
ESD Sensitivity	ESD	2000	V
Storage Temperature	T _{stg}	-40 ~ +100	°C
Thermal Resistance (Junction / Soldering point)	R _{th J-S}	11	°C/W
Junction Temperature	T _j	115	°C
Soldering Temperature	T _{sol}	Reflow Soldering : 260 °C for 10 sec. Hand Soldering : 350 °C for 3 sec.	

Electro-Optical Characteristics (T_{Soldering}=25°C)

Parameter	Symbol	Min.	Typ.	Max.	Unit	Condition
Luminous Flux ₍₁₎	Φ	26	-----	39	lm	I _F =65mA
Forward Voltage ₍₂₎	V _F	2.6	-----	2.9	V	I _F =65mA
Color Rendering Index ₍₃₎	Ra	90	-----	-----	-----	I _F =65mA
	R9	50	-----	-----	-----	I _F =65mA
Viewing Angle	2θ _{1/2}	-----	120	-----	deg	I _F =65mA

Notes:

1. Tolerance of Luminous flux: ±11%.
2. Tolerance of Forward Voltage: ±0.1V.
3. Tolerance of Color Rendering Index: ±2

Bin Range of Luminous Flux

2700K----G62-127ET/RK7D-3M2727V6X62629U6/2T

Bin Code	Min.	Max.	Unit	Condition
T1	26	28	lm	I _F =65mA
T2	28	30		
T3	30	32		
T4	32	34		
T5	34	36		

3000K----G62-127ET/RK7D-3M3030V7X72629U6/2T

Bin Code	Min.	Max.	Unit	Condition
T1	27	29	lm	I _F =65mA
T2	29	31		
T3	31	33		
T4	33	35		
T5	35	37		

3500K----G62-127ET/RK7D-3M3535V7X72629U6/2T

Bin Code	Min.	Max.	Unit	Condition
T1	27	29	lm	I _F =65mA
T2	29	31		
T3	31	33		
T4	33	35		
T5	35	37		

4000K----G62-127ET/RK7D-3M4040V8X82629U6/2T

Bin Code	Min.	Max.	Unit	Condition
T1	28	30	lm	I _F =65mA
T2	30	32		
T3	32	34		
T4	34	36		
T5	36	38		

5000K----G62-127ET/RK7D-3M5050V9X92629U6/2T

Bin Code	Min.	Max.	Unit	Condition
T1	29	31	lm	I _F =65mA
T2	31	33		
T3	33	35		
T4	35	37		
T5	37	39		

5700K----G62-127ET/RK7D-3M5757V9X92629U6/2T

Bin Code	Min.	Max.	Unit	Condition
T1	29	31	lm	I _F =65mA
T2	31	33		
T3	33	35		
T4	35	37		
T5	37	39		

6500K----G62-127ET/RK7D-3M6565V8X82629U6/2T

Bin Code	Min.	Max.	Unit	Condition
T1	28	30	lm	I _F =65mA
T2	30	32		
T3	32	34		
T4	34	36		
T5	36	38		

Notes:
 Tolerance of Luminous flux: ±11%

Bin Range of Forward Voltage

Group	Bin Code	Min.	Max.	Unit	Condition
2629	33	2.6	2.7	V	I _F =65mA
	34	2.7	2.8		
	35	2.8	2.9		

Bin Code of Macadam 3 step

Step	CCT	Cx	Cy	a	b	theta
3	2700	0.4583	0.4104	0.00810	0.00420	49.70
	3000	0.4345	0.4033	0.00834	0.00408	50.22
	3500	0.4080	0.3919	0.00927	0.00414	51.00
	4000	0.3827	0.3803	0.00939	0.00402	54.80
	5000	0.3474	0.3559	0.00822	0.00354	64.12
	5700	0.3293	0.3423	0.00747	0.00321	66.51
	6500	0.3131	0.3290	0.00669	0.00285	64.57

The C.I.E. 1931 Chromaticity Diagram

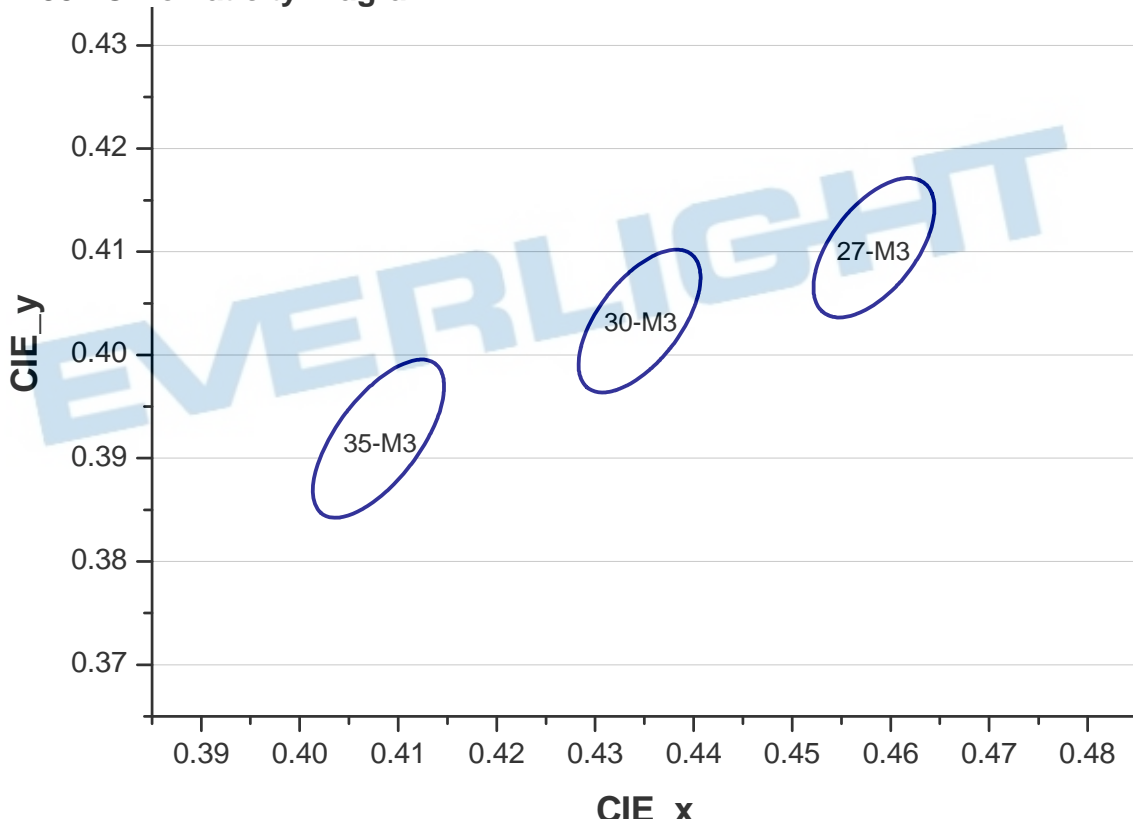

The C.I.E. 1931 Chromaticity Diagram

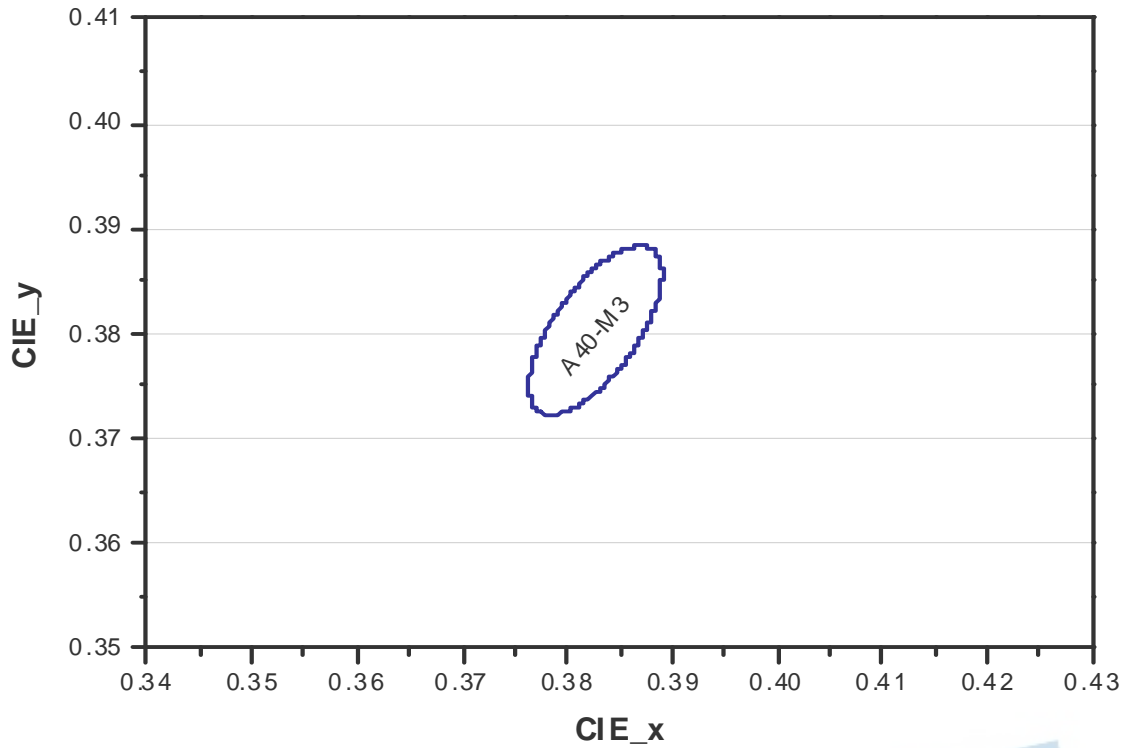

The C.I.E. 1931 Chromaticity Diagram

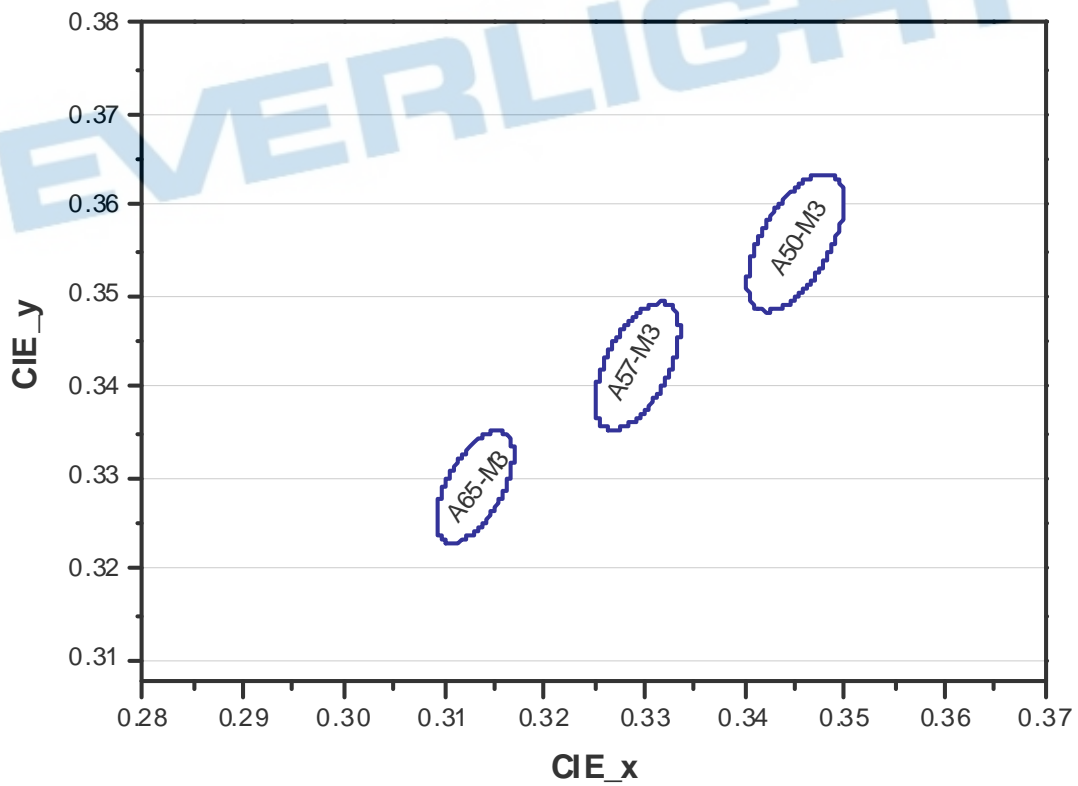

Note:

1. The value is based on driving current by 65mA.
2. Tolerance of Chromaticity Coordinates: ± 0.01 .

Spectrum Distribution

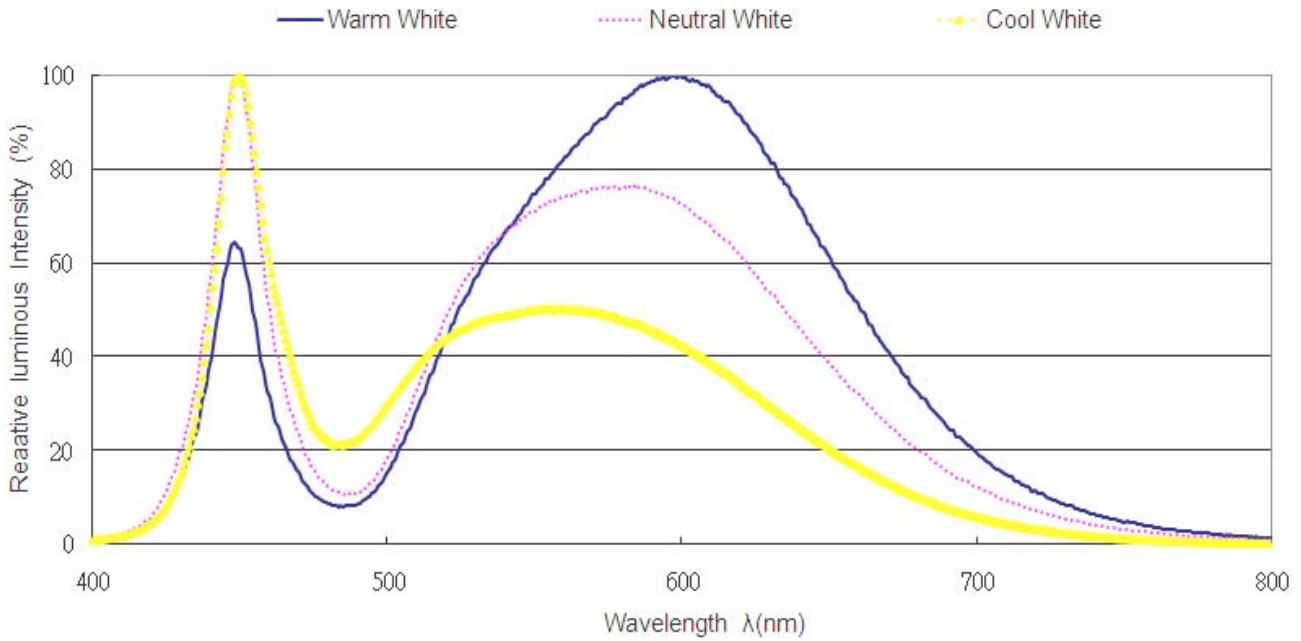

Typical Electro-Optical Characteristics Curves

Fig.1 – Forward Voltage Shift vs. Junction Temperature

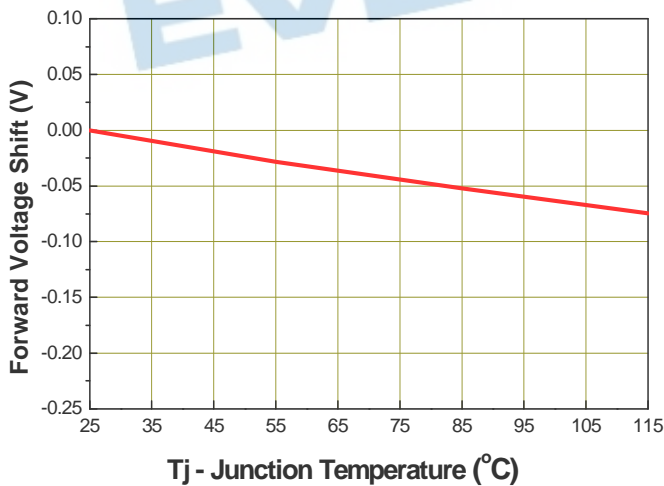
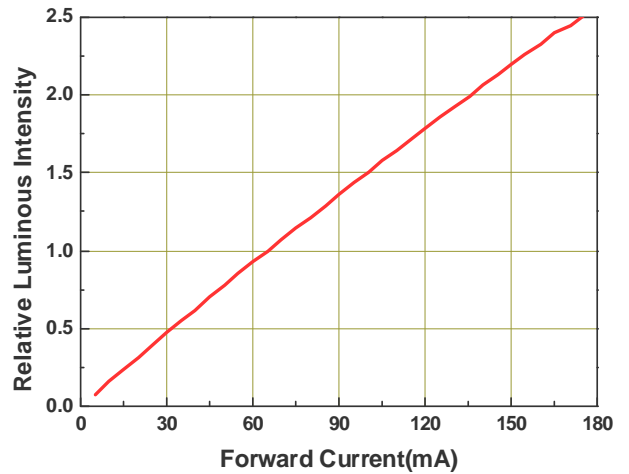

Fig.2 - Relative Luminous Intensity vs. Forward Current



Typical Electro-Optical Characteristics Curves

Fig.3 - Relative Luminous Intensity vs. Junction Temperature

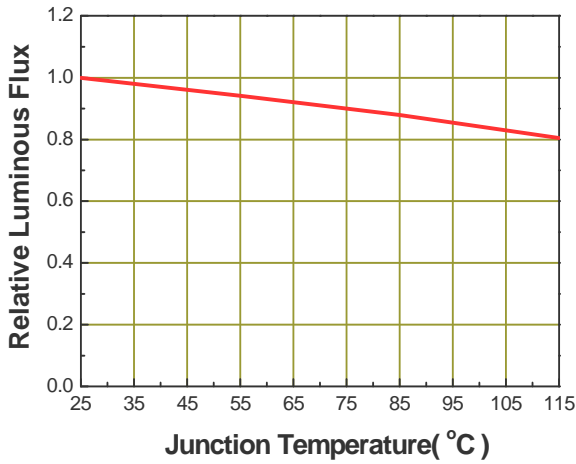

Fig.4 - Forward Current vs. Forward Voltage

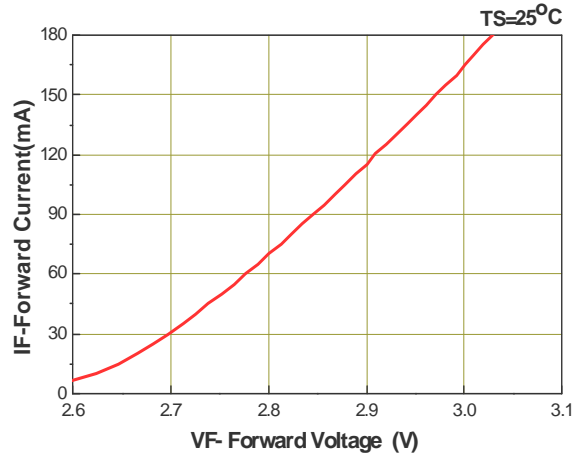

Fig.5 – Max. Driving Forward Current vs. Soldering Temperature

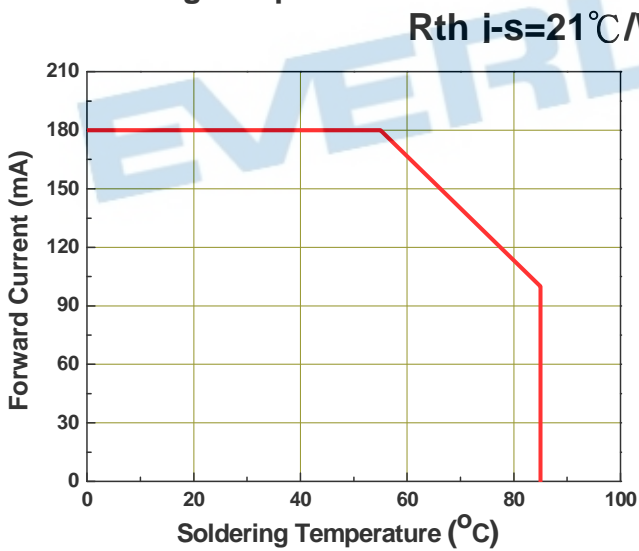
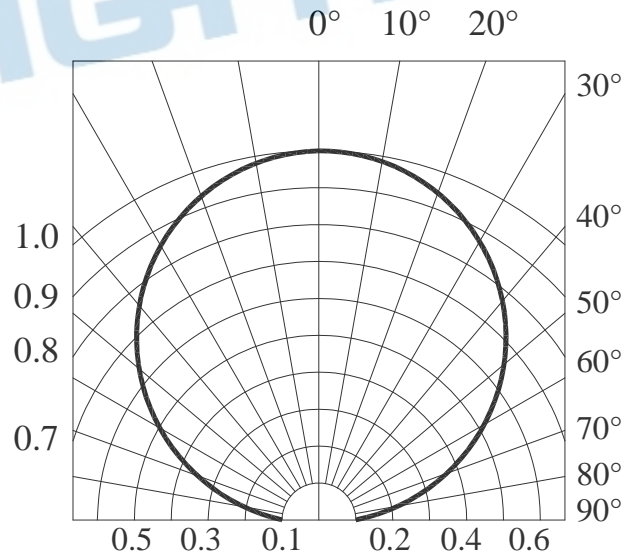
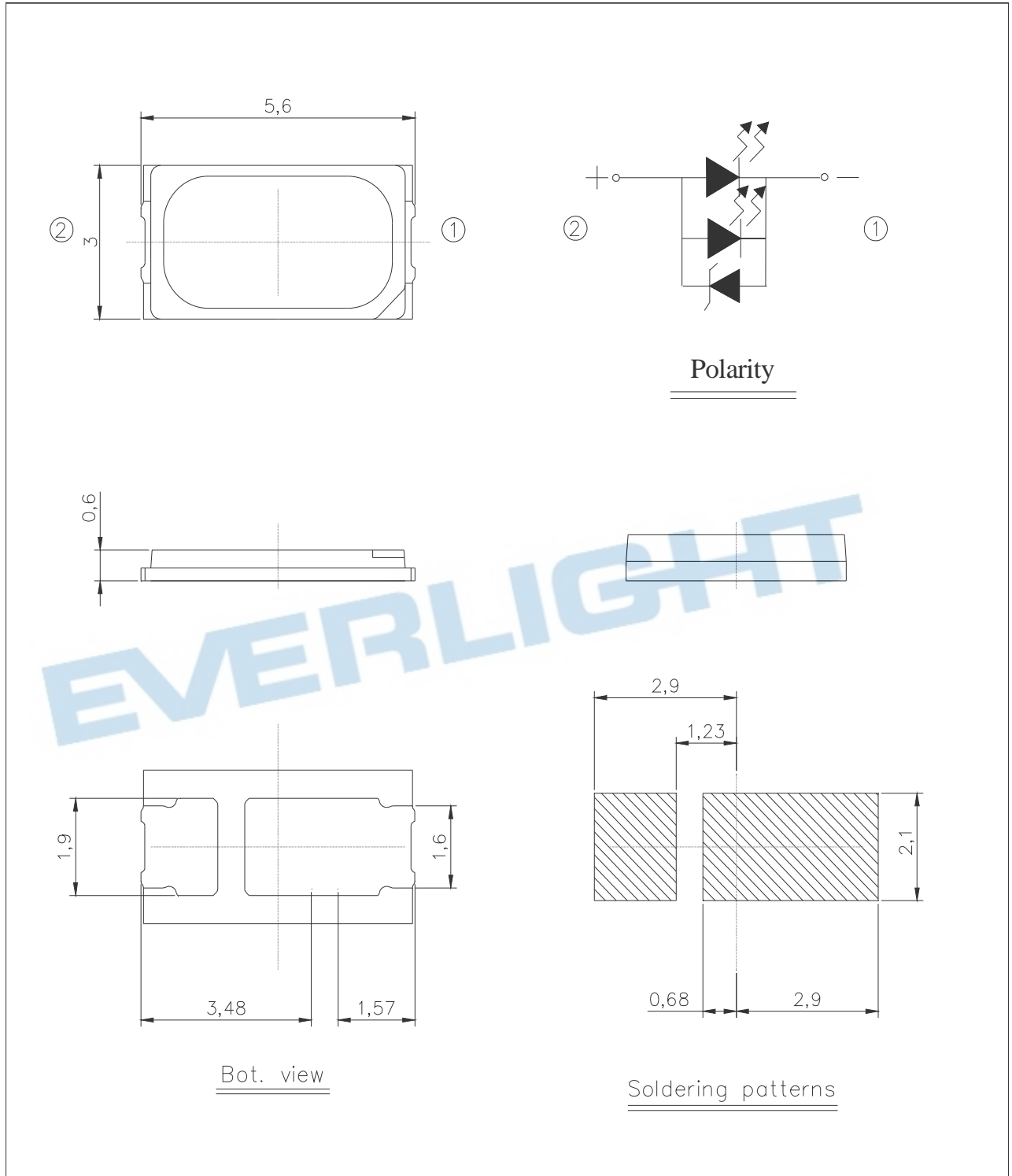

Fig.6 – Radiation Diagram



Package Dimension



Note:
Tolerance unless mentioned is ± 0.2 mm; Unit = mm

Moisture Resistant Packing Materials

Label Explanation

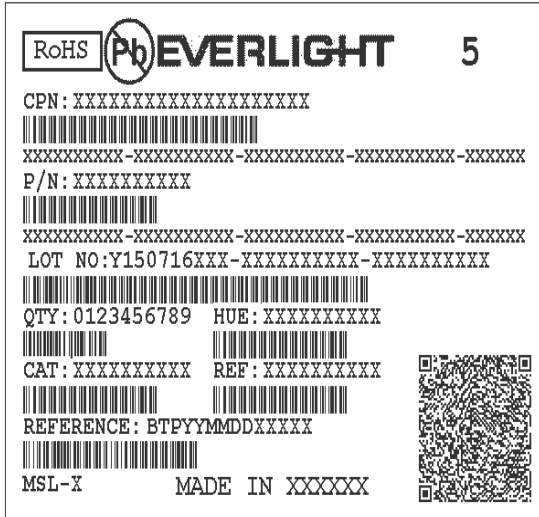

- CPN: Customer's Product Number
- P/N: Product Number
- QTY: Packing Quantity
- CAT: Luminous Intensity Rank
- HUE: Dom. Wavelength Rank
- REF: Forward Voltage Rank
- LOT No: Lot Number

Reel Dimensions

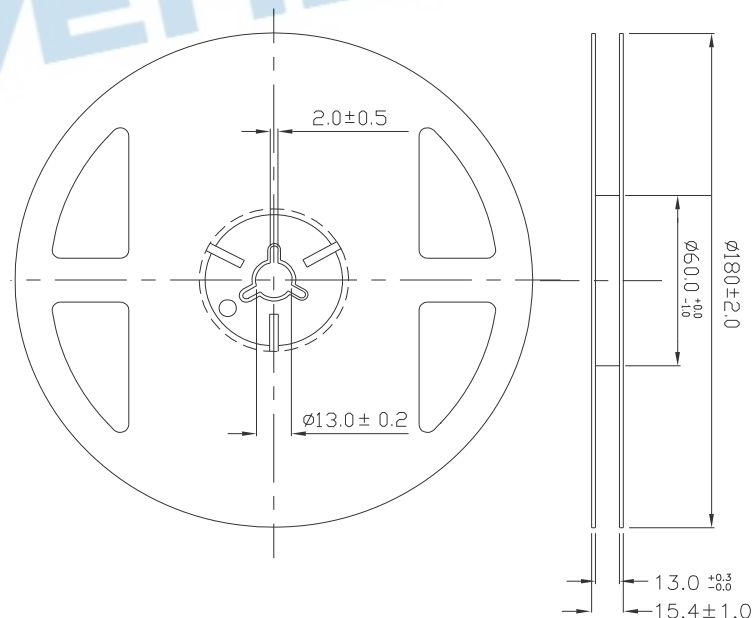

Note:
 Tolerances unless mentioned ± 0.1 mm. Unit = mm.

Carrier Tape Dimensions: Loaded Quantity 2000 pcs. Per Reel

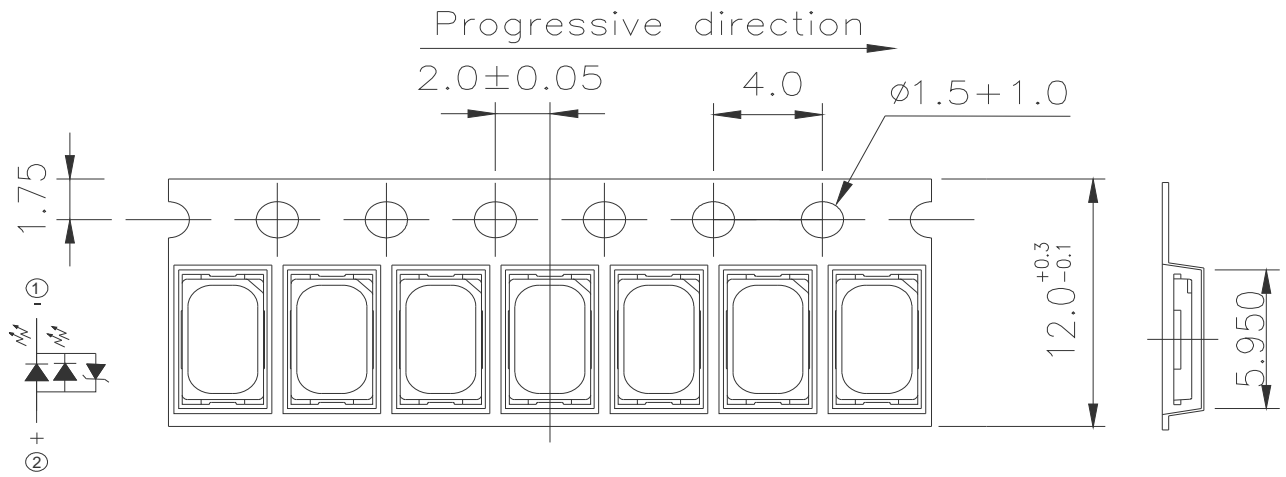

Note:
 Tolerances unless mentioned ± 0.1 mm. Unit = mm.

Moisture Resistant Packing Process

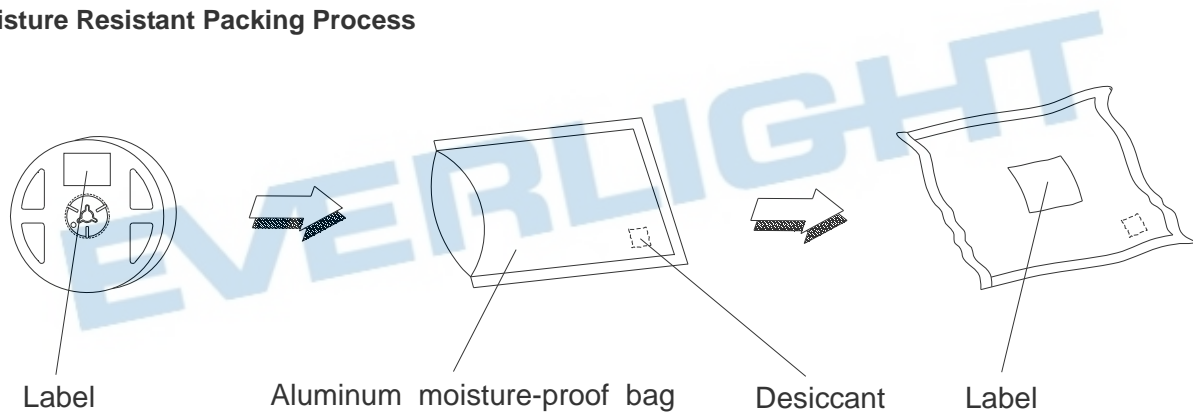

Reliability Test Items and Conditions

The reliability of products shall be satisfied with items listed below.
 Confidence level : 90%
 LTPD : 10%

No.	Items	Test Condition	Test Hours/Cycles	Sample Size	Ac/Re
1	Reflow Soldering	Temp. : 260°C/10sec.	6 Min.	22 PCS.	0/1
2	Thermal Shock	H : +100°C 5min ∫ 10 sec L : -10°C 5min	200 Cycles	22 PCS.	0/1
3	Temperature Cycle	H : +100°C 15min ∫ 5 min L : -40°C 15min	200 Cycles	22 PCS.	0/1
4	High Temperature/Humidity Reverse Bias	Ta=85°C,85%RH	1000 Hrs.	22 PCS.	0/1
5	High Temperature/Humidity Operation	Ta=85°C,85%RH, I _F = 100 mA	1000 Hrs.	22 PCS.	0/1
6	Low Temperature Storage	Ta=-40°C	1000 Hrs.	22 PCS.	0/1
7	High Temperature Storage	Ta=85°C	1000 Hrs.	22 PCS.	0/1
8	Low Temperature Operation Life	Ta=-40°C, I _F = 150 mA	1000 Hrs.	22 PCS.	0/1
9	High Temperature Operation/ Life#1	Ta=25°C, I _F = 150 mA	1000 Hrs.	22 PCS.	0/1
10	High Temperature Operation/ Life#2	Ta=55°C, I _F =150 mA	1000 Hrs.	22 PCS.	0/1
11	High Temperature Operation/ Life#3	Ta=85°C, I _F = 100 mA	1000 Hrs.	22 PCS.	0/1

Precautions for Use

1. Over-current-proof
Customer must apply resistors for protection; otherwise slight voltage shift will cause big current change (Burn out will happen).
2. Storage
 - 2.1 Do not open moisture proof bag before the products are ready to use.
 - 2.2 Before opening the package: The LEDs should be kept at 30°C or less and 90%RH or less.
 - 2.3 After opening the package: The LED's floor life is 72 Hrs under 30°C or less and 60% RH or less. If unused LEDs remain, it should be stored in moisture proof packages.
 - 2.4 If the moisture absorbent material (silica gel) has faded away or the LEDs have exceeded the storage time, baking treatment should be performed using the following conditions.
Baking treatment: 60±5°C for 24 hours.

3. Soldering Condition

3.1 Pb-free solder temperature profile

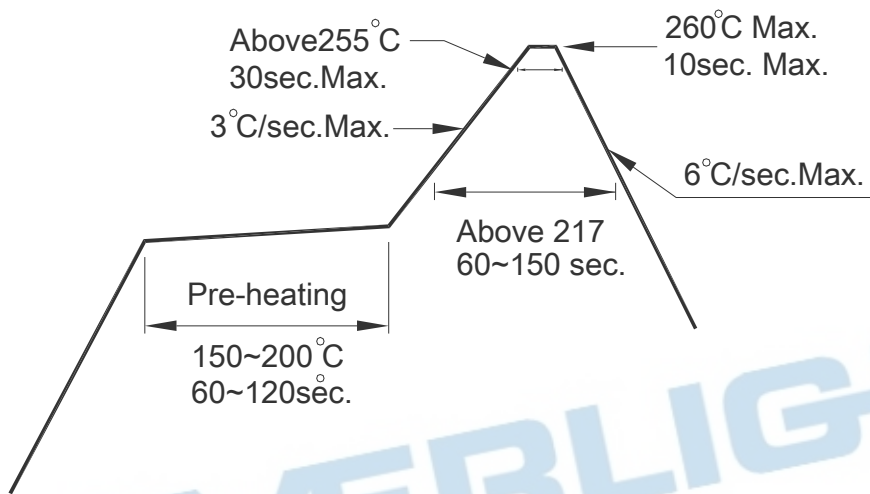

- 3.2 Reflow soldering should not be done more than two times.
- 3.3 When soldering, do not put stress on the LEDs during heating.
- 3.4 After soldering, do not warp the circuit board.

4. Soldering Iron

Each terminal is to go to the tip of soldering iron temperature less than 350°C for 3 seconds within once in less than the soldering iron capacity 25W. Leave two seconds and more intervals, and do soldering of each terminal. Be careful because the damage of the product is often started at the time of the hand solder.

5. Repairing

Repair should not be done after the LEDs have been soldered. When repairing is unavoidable, a double-head soldering iron should be used (as below figure). It should be confirmed beforehand whether the characteristics of the LEDs will or will not be damaged by repairing.

