



---

Simplifying System Integration™

# **73S8009C**

## **Demo Board User Manual**

**February 10, 2010**  
**Rev. 1.3**  
**UM\_8009C\_059**

© 2010 Teridian Semiconductor Corporation. All rights reserved.  
Teridian Semiconductor Corporation is a registered trademark of Teridian Semiconductor Corporation.  
Simplifying System Integration is a trademark of Teridian Semiconductor Corporation.  
All other trademarks are the property of their respective owners.

Teridian Semiconductor Corporation makes no warranty for the use of its products, other than expressly contained in the Company's warranty detailed in the Teridian Semiconductor Corporation standard Terms and Conditions. The company assumes no responsibility for any errors which may appear in this document, reserves the right to change devices or specifications detailed herein at any time without notice and does not make any commitment to update the information contained herein. Accordingly, the reader is cautioned to verify that this document is current by comparing it to the latest version on <http://www.teridian.com> or by checking with your sales representative.

Teridian Semiconductor Corp., 6440 Oak Canyon, Suite 100, Irvine, CA 92618  
TEL (714) 508-8800, FAX (714) 508-8877, <http://www.teridian.com>

## Table of Contents

<b>1</b>	<b>Introduction .....</b>	<b>5</b>
1.1	Package Contents.....	5
1.2	Safety and ESD Notes .....	5
1.3	Recommended Operating Conditions and Absolute Maximum Ratings.....	6
1.4	Notes When Using a 73S12xxF Evaluation Board .....	6
<b>2</b>	<b>Connections.....</b>	<b>7</b>
<b>3</b>	<b>Jumpers, Switches and Test Points .....</b>	<b>9</b>
<b>4</b>	<b>Design Considerations.....</b>	<b>12</b>
4.1	General Layout Rules .....	12
4.2	Optimization for Compliance with EMV.....	12
4.3	Power Supply Input Configurations .....	12
4.3.1	USB Power .....	12
4.3.2	Single Supply Power .....	12
4.4	ON/OFF Switch Operation .....	13
<b>5</b>	<b>73S8009C Demo Board Schematics, PCB Layouts and Bill of Materials .....</b>	<b>14</b>
5.1	Schematics.....	14
5.2	73S8009C PCB Layouts .....	15
5.3	73S8009C Demo Board Bill of Materials.....	18
<b>6</b>	<b>Errata.....</b>	<b>18</b>
<b>7</b>	<b>Ordering Information.....</b>	<b>19</b>
<b>8</b>	<b>Related Documentation.....</b>	<b>19</b>
<b>9</b>	<b>Contact Information.....</b>	<b>19</b>
	<b>Revision History .....</b>	<b>20</b>

## Figures

Figure 1: 73S8009C Demo Board .....	5
Figure 2: 73S8009C Demo Board External Connectors.....	7
Figure 3: 73S8009C Demo Board Description.....	9
Figure 4: 73S8009C Electrical Schematic .....	14
Figure 5: 73S8009C Demo Board: Top View.....	15
Figure 6: 73S8009C Demo Board: Bottom View.....	15
Figure 7: 73S8009C Demo Board: Top Signal Layer.....	16
Figure 8: 73S8009C Demo Board: Middle Layer 1, Ground Plane.....	16
Figure 9: 73S8009C Demo Board: Middle Layer 2, Supply Plane.....	17
Figure 10: 73S8009C Demo Board: Bottom Signal Layer .....	17

## Tables

Table 1: Recommended Operating Conditions.....	6
Table 2: Absolute Maximum Ratings.....	6
Table 3: J4 Pin Descriptions .....	7
Table 4: J2 Pin Descriptions .....	8
Table 5: 73S8009C Demo Board Description.....	10
Table 6: 73S8009C Demo Board Bill of Materials.....	18
Table 7: 73S8009C Demo Board Order Number .....	19

## 1 Introduction

The Teridian Semiconductor Corporation 73S8009C Demo Board is a platform for evaluating the Teridian 73S8009C 32-pin QFN Smart Card Interface IC. It incorporates the 73S8009C integrated circuit, and it is designed to operate either as a standalone platform (to be used in conjunction with an external microcontroller) or as a daughter card to be used in conjunction with the 73S12xxF evaluation platform.

### 1.1 Package Contents

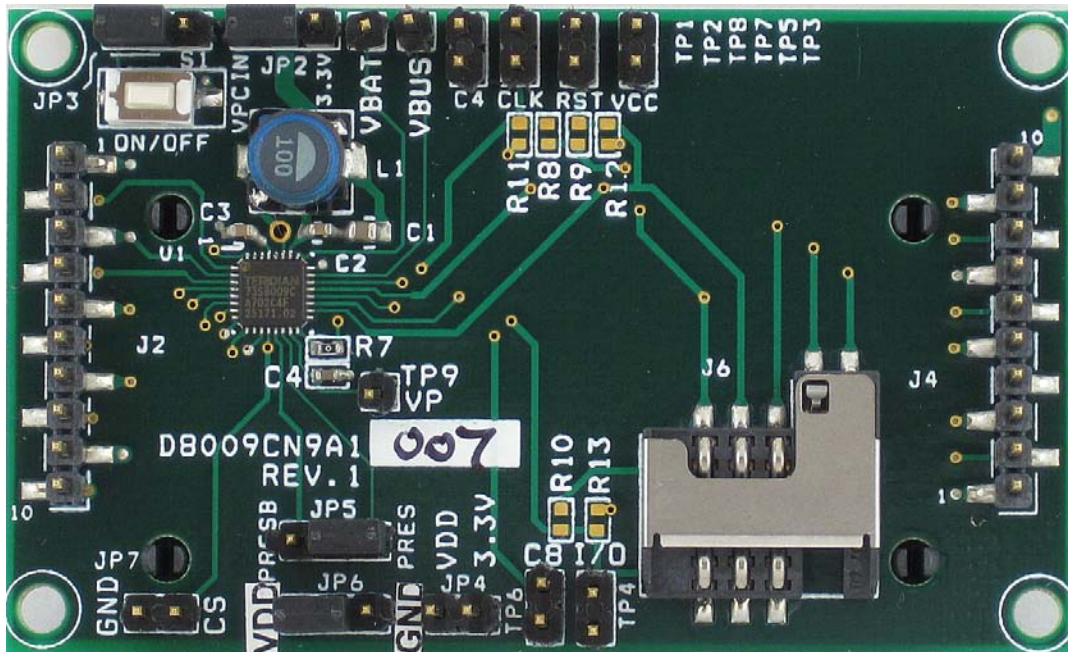

Figure 1: 73S8009C Demo Board

The 73S8009C Demo Board Kit includes:

- A 73S8009C Demo Board (Rev. 1)
- The following documents:
  - *73S8009C Data Sheet*
  - *73S8009C Demo Board User Manual* (this document)

### 1.2 Safety and ESD Notes

Connecting live voltages to the 73S8009C Demo Board system will result in potentially hazardous voltages on the boards.



**Extreme caution should be taken when handling the 73S8009C Demo Board after connection to live voltages!**



**The 73S8009C Demo Board is ESD sensitive! ESD precautions should be taken when handling this board!**

### 1.3 Recommended Operating Conditions and Absolute Maximum Ratings

**Table 1: Recommended Operating Conditions**

Parameter	Rating
Supply Voltage $V_{PC}$	2.7 to 6.5 VDC
Supply Voltage $V_{BUS}$	4.4 to 5.5 VDC
Supply Voltage $V_{BAT}$	4.0 to 6.5 °C
Ambient Operating Temperature	-40 °C to +85 °C

**Table 2: Absolute Maximum Ratings**

Parameter	Rating
Supply Voltage $V_{BUS}$	-0.5 to 6.6 VDC
Supply Voltage $V_{BAT}$	-0.5 to 6.6 VDC
Supply Voltage $V_{PC}$	-0.5 to 6.6 VDC
Input Voltage for Digital Inputs	-0.3 to ( $V_{DD}+0.5$ ) VDC
Storage Temperature	-60 to 150 °C
Pin Voltage (except card interface)	-0.3 to ( $V_{DD}+0.5$ ) VDC
Pin Voltage (card interface)	-0.3 to ( $V_{CC}+0.3$ ) VDC
Pin Voltage, LIN pin	0.3 to 6.5 VDC
ESD Tolerance – Card interface pins	± 6 kV
ESD Tolerance – Other pins	± 2 kV
Pin Current	± 200 mA

Operation outside these rating limits may cause permanent damage to the device.

ESD testing on Card pins is HBM condition, 3 pulses, each polarity referenced to ground.

### 1.4 Notes When Using a 73S12xxF Evaluation Board

The 73S12xxF Evaluation Board has two power supplies; 3.3 V and 5.0 V. Normally, the 5.0 V supply is tied to VPC IN on the 73S8009C board. The 73S8009C can supply the 3.3 V to the remainder of the system by configuring the jumpers accordingly. The 73S8009C VDD output can be disconnected from the rest of the evaluation board if desired and the 3.3 V supply on the 73S12xxF Evaluation Board can be used. See the jumper descriptions for more details.

## 2 Connections

This section describes the 73S8009C Demo Board external connectors. All the digital signals and power supply connections are made through 10-pin header connectors labeled J2 and J4 in Figure 2.

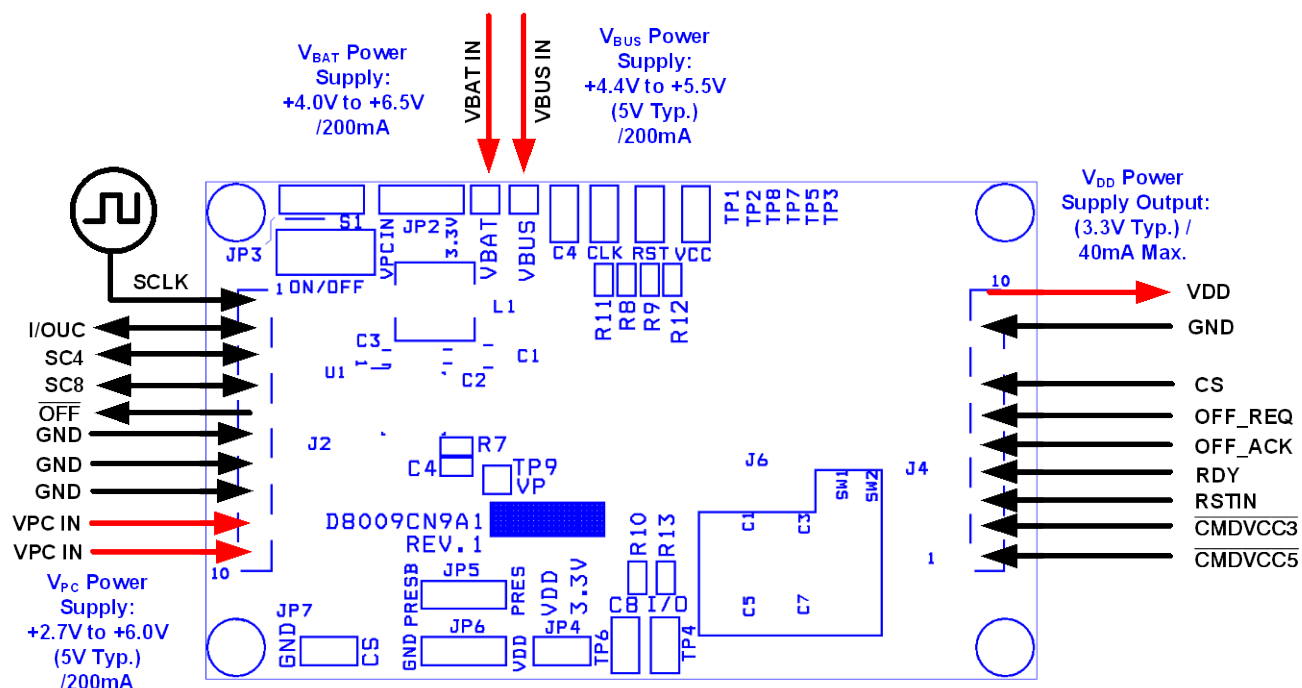

Figure 2: 73S8009C Demo Board External Connectors

Table 3 describes the pins for the J4 connector. There is one power pin (Pin 1) and one ground pin (Pin 9).

Table 3: J4 Pin Descriptions

Pin	Pin Name	Function
1	CMDVCC5	Controls the turn-on, output voltage value, and turn-off of $V_{CC}$ .
2	CMDVCC3	
3	RSTIN	Controls the card reset signal.
4	RDY	Indicates when smart card power supply is stable and ready.
5	OFF_ACK	Setting OFF_ACK high powers “off” all analog functions and disconnects the 73S8009C from $V_{BAT}$ or $V_{PC}$ .
6	OFF_REQ	Digital output. Request to the host system controller to turn the 73S8009C off.
7	CS	Chip Select – active high.
8	N/C	No Connect.
9	GND	Ground.
10	VDD	System interface supply voltage and supply voltage for companion controller circuitry.

Table 4 describes the J2 connector pins.

**Table 4: J2 Pin Descriptions**

Pin	Pin Name	Function
1	SCLK	Clock source input.
2	I/OUC	System controller data I/O to/from the card.
3	SC4	System controller auxiliary data C4 to/from the card.
4	SC8	System controller auxiliary data C8 to/from the card.
5	$\overline{\text{OFF}}$	Interrupt signal to the processor. Indicator of card presence and any card fault conditions.
6	GND	Ground.
7	GND	Ground.
8	GND	Ground.
9	VPC IN	Must be between 2.7 V and 6.5 V.
10	VPC IN	Must be between 2.7 V and 6.5 V.

Connections should be made in this order:

- Power Supplies: Apply 3.3 V to pin 10 of J4 or 5 V to pins 9 and 10 of J2 depending on the setting of JP2.
- Press the ON/OFF button.
- Control signals to the device can be connected through J2 and J4. See Figure 2 and Figure 4.
- Apply the clock signal.



### 3 Jumpers, Switches and Test Points

The items marked in Figure 3 are described in Table 5.

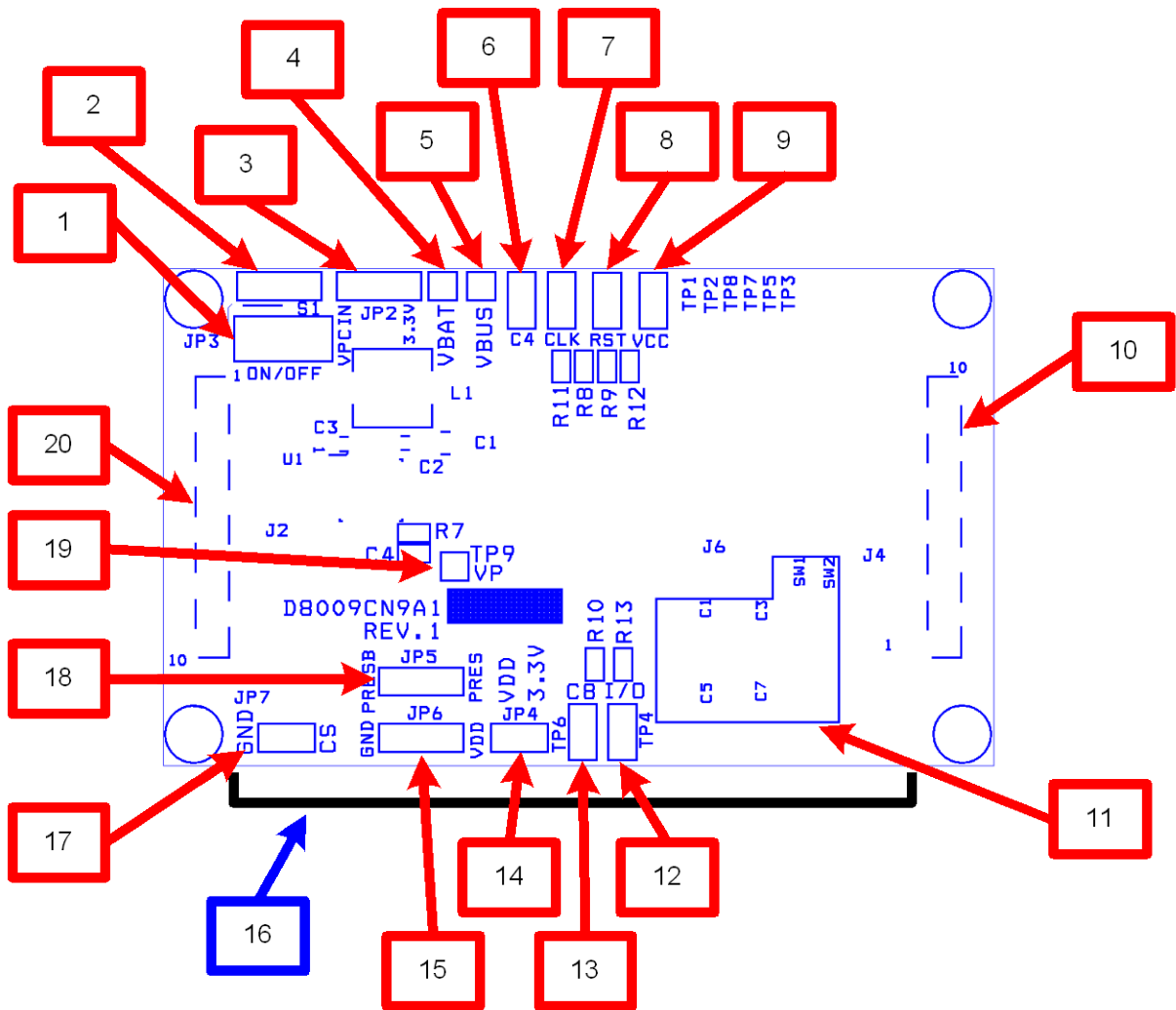

Figure 3: 73S8009C Demo Board Description

**Table 5: 73S8009C Demo Board Description**

Item # (Figure 3)	Electrical Schematic & PCB Silkprint Reference	Name	Use
1	S1	ON/OFF switch	Push-button switch to turn on/off the 73S8009C. Note: OFF_ACK must be set high to turn off.
2	JP3	ON_OFF Jumper	When set to 1-2, the ON_OFF input is set to ground which turns on the 73S8009C when power is applied. When set to 2-3, the push button switch is connected to the ON_OFF pin. When using VBUS as an always on configuration, JP3 must be set to the 1-2 position and the OFF_ACK input must be grounded.
3	JP2	VPC Select	The VPC input can select between the VPC_IN and the 3.3 V inputs. When selecting the VPC_IN, the VDD output can source the 3.3 V supply on the evaluation board. See the description for JP4.
4 5 6 7 8 9 12 13	TP1 TP2 TP8 TP7 TP5 TP3 TP4 TP6	Test Points: VBAT Test point VBUS Test point C4 CLK RST VCC I/O C8	VBAT Input VBUS Input  Two-pin test points for each respective smart card signal. The pin label name is the respective signal (i.e. VCC, CLK) and the other pin is GND.
10	J4	Board 3.3 V supply and digital control signals	Connector that either gathers or supplies the 3.3 V supply. It includes the 73S8009C host control signal pins RDY, CS, OFF_REQ, OFF_ACK, CMDVCC5, CMDVCC3, and RSTIN.
11	J6	Smart Card Connector	SIM/SAM smart card format connector. Note that J6 is wired in parallel to the smart card connector J5 (underneath the PCB). J5 and J6 are never to be used at the same time.
14	JP4	VDD Select	When the jumper is inserted, the 73S8009C VDD output is connected to the 3.3 V power plane. When using in conjunction with a 73S12xxF Evaluation Board or other host, it supplies the 3.3 V source on the on that platform if it is so configured. Caution must be taken as damage could occur if the 73S12xxF Evaluation Board or host is sourcing 3.3 V with this jumper inserted. Removal of the jumper provides proper isolation with any host platform.

Item # (Figure 3)	Electrical Schematic & PCB Silkprint Reference	Name	Use
15 18	JP6 JP5	Card Polarity detect select	<p>The setting of these two jumpers depends on the type of smart card connector used (whether switch is nominally open or closed), and which of the card presence switch input of the 73S8009C is used. In this demo board, the switch is nominally open. The jumpers can be set in one of two ways:</p> <ol style="list-style-type: none"> <li>1. Default setting: Use of PRES: JP5 must be set to PRES, and JP6 set to VDD</li> <li>2. Alternative use: Use of <math>\overline{\text{PRES}}</math>: JP5 must be set to PREB, and JP6 set to GND</li> </ol> <p>Note: see board errata in the appendix for JP6</p>
16	J5	Smart Card Connector	<p>Smart card connector. When inserting a card (credit card size format), contacts must face up.</p>
17	JP7	CS Disable	<p>CS Disable Jumper. Insertion of jumper disables the 73S8009CN. The state of the <math>\overline{\text{CMDVCC3}}</math>, <math>\overline{\text{CMDVCC5}}</math> and RSTIN inputs will be latched and the I/OUC, AUX1UC and AUX2UC are tri-stated. The <math>\overline{\text{OFF}}</math> and RDY outputs are also tri-stated.</p>
19	TP9	Vp Test Point	<p>Test point to monitor the internal intermediate voltage regulator. This regulator output takes the VPC voltage and step it up to more than 5 V (if necessary) as the input source for the VCC and VDD output regulators.</p>
20	J3	Board VPC_IN supply, smart card data signals and $\overline{\text{OFF}}$	<p>Connector that supplies the VPC input supply voltage, the smart card data interface signals and the <math>\overline{\text{OFF}}</math> interrupt output.</p>

## 4 Design Considerations

### 4.1 General Layout Rules

Follow these layout rules:

- Route I/O and auxiliary signals away from card interface signals.
- Keep CLK trace as short as possible and with minimal bends in the trace. If possible, keep routing of the CLK trace to one layer (avoid vias to other layers). Keep CLK trace away from other traces especially RST, I/O and VCC. Filtering of the CLK trace is allowed for noise purposes. Up to 30 pF to ground is allowed at the CLK pin of the smart card connector. Also, the zero  $\Omega$  series resistor (R7) can be replaced with a small resistor for additional filtering (no more than 100  $\Omega$ ).
- Keep VCC trace as short as possible. Make trace a minimum of 0.5 mm thick. Also, keep VCC away from other traces especially RST and CLK.
- Keep RST trace away from VCC and CLK traces. Up to 30 pF to ground is allowed for filtering.
- Keep 0.1  $\mu$ F close to VDD pin of the device and directly take other end to ground.
- Keep 0.1  $\mu$ F and 10  $\mu$ F close to VPC pin of the device and directly take other end to ground.
- Keep 4.7  $\mu$ F close to VP pin of the device and directly take other end to ground.
- Keep 0.47  $\mu$ F close to VCC pin of the smart card connector and directly take other end to ground.

### 4.2 Optimization for Compliance with EMV

Default configuration of the Demo board contains a 27 pF capacitor (C12) from the CLK pin of the smart connector to ground and a 27 pF capacitor (C13) from the RST pin of the smart connector to ground. These capacitors serve as filters for CLK and RST signals in the case of long traces or test equipment perturbations. The capacitor on CLK reduces ringing on the trace, reduces coupling to other traces and slows down the edge of the CLK signal. The capacitor on RST helps the perturbation specification in a noisy environment. The filter capacitors can be useful in the EMV test environment and have no effect on NDS testing

C12 and C13 are represented on both schematic and BOM. These capacitors are optional filter capacitors on the smart card lines CLK and RST, respectively for each card interface. These capacitors may be adjusted (value, not to exceed 30 pF) or removed to optimize performance in each specific application (PCB, card clock frequency, compliance with applicable standards etc).

### 4.3 Power Supply Input Configurations

#### 4.3.1 USB Power

The USB configuration uses the power supplied by the VBUS (4.4 to 5.5 V) and an optional VBAT input that automatically switches from the VBUS to VBAT when the VBUS power is removed. This switch over is done smoothly and does not cause any disruption of the operation of the 73S8009C and the VDD output supply. The operation of the ON/OFF switch is overridden when VBUS is applied. The 73S8009C and VDD output will always be active while the VBUS voltage is applied. The ON/OFF switch is enabled when running off VBAT. When using this configuration, the VPC input should not be connected to any other power source.

#### 4.3.2 Single Supply Power

The single supply configuration should leave the VBUS and VBAT pins unconnected and only connect the power supply to VPC (2.7 to 6.0 V).

#### 4.4 ON/OFF Switch Operation

The ON/OFF switch uses a pushbutton to toggle between turning the 73S8009C on and off. The switch input contains a debounce circuit for protection. The 73S8009C defaults to the OFF state when the power source is applied. When the 8009C is in the OFF state, a switch closure turns on the 73S8009C. When the 73S8009C is ON, a switch closure does not turn off the 73S8009C by itself, but it activates the OFF\_REQ signal by setting it high. The 73S8009C does not shut off until the OFF\_ACK is set high. The purpose of this sequence is to allow the host processor to perform any necessary shut down tasks before losing power. When the host is finished, it can set the OFF\_ACK signal high to shut off the 73S8009C. If there is no need for the host to perform any shutdown tasks, the OFF\_ACK pin can be left open and it follows the state of the OFF\_REQ output by means of an internal resistor connection between the OFF\_REQ and OFF\_ACK pins.

- ✓ When power is applied to VBUS, the 73S8009C automatically turns on and the ON/OFF switch is overridden. However, care must be taken as the ON\_OFF input is internally latched while the VBUS is applied. When VBUS is removed, the latched state of the ON/OFF switch input dictates the state of the 73S8009C. If the switch input was not closed, the state of this latch will not change. It will be in the same state before the VBUS power was applied. If it has changed it holds the last toggled state. The OFF\_REQ output follows this toggling. If the OFF\_REQ output is high when VBUS power is removed and the OFF\_ACK is high, the 73S8009C shuts off.

# 5 73S8009C Demo Board Schematics, PCB Layouts and Bill of Materials

## 5.1 Schematics

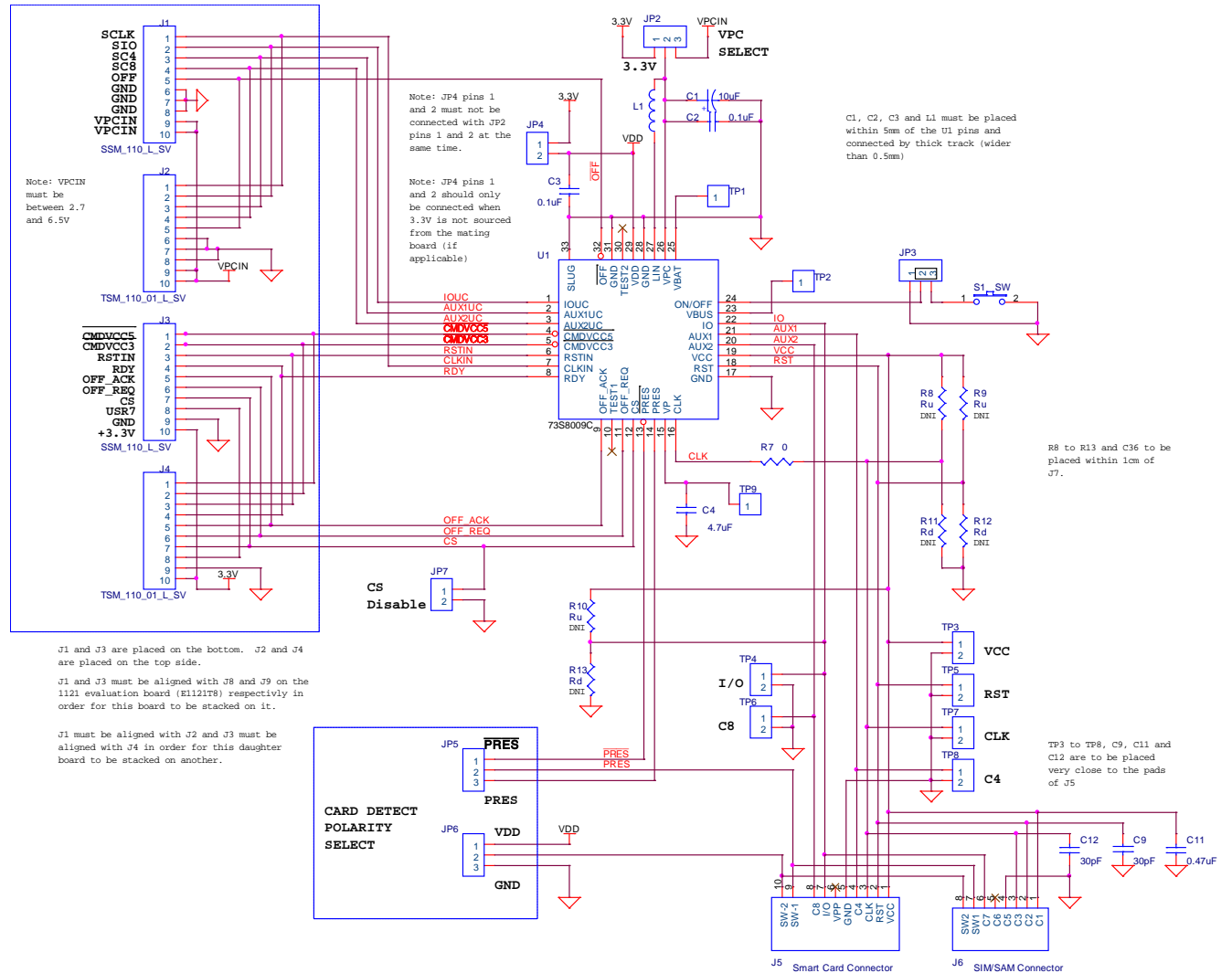

Figure 4: 73S8009C Electrical Schematic



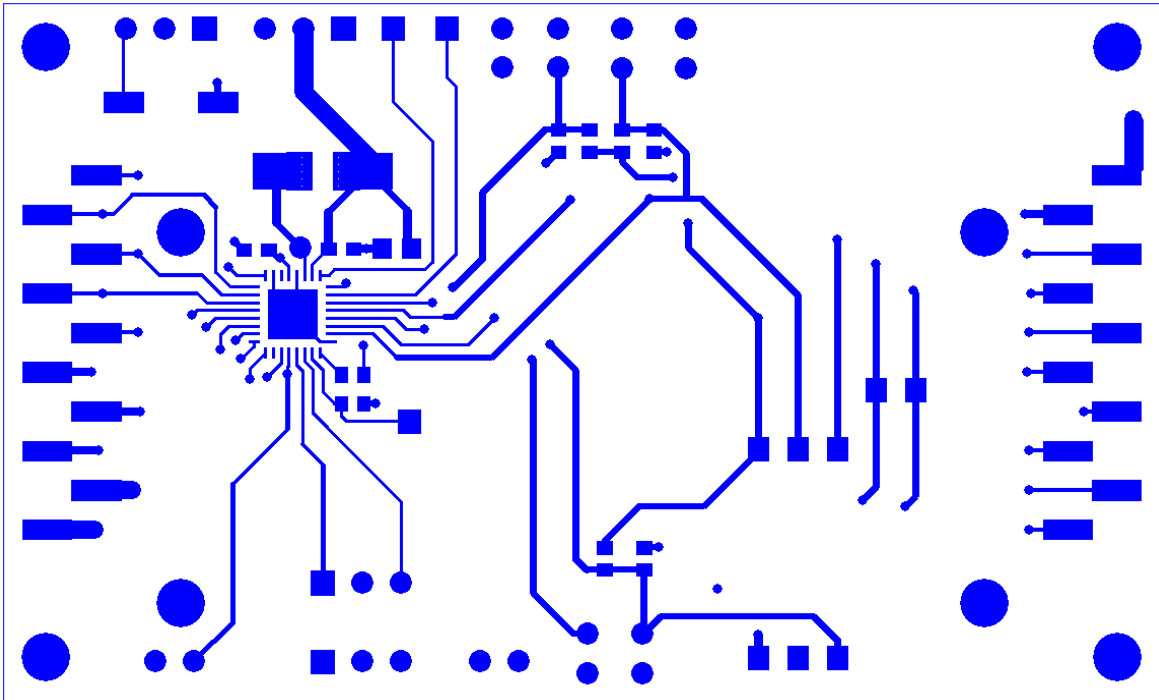

Figure 7: 73S8009C Demo Board: Top Signal Layer

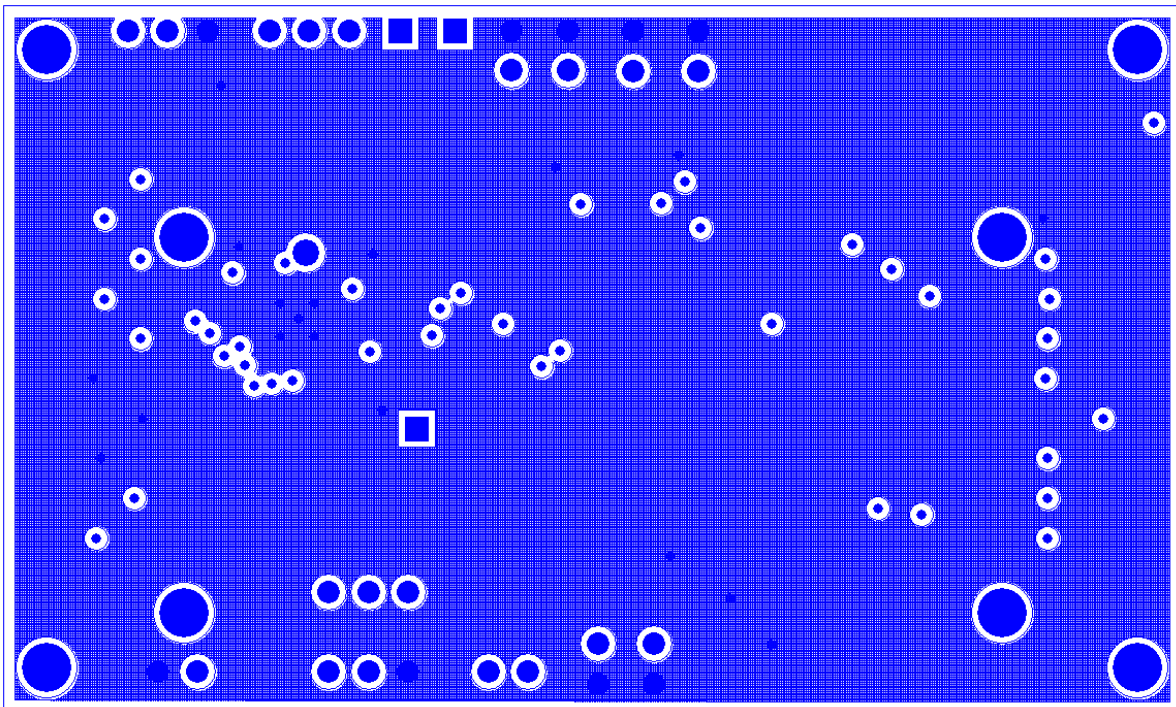

Figure 8: 73S8009C Demo Board: Middle Layer 1, Ground Plane



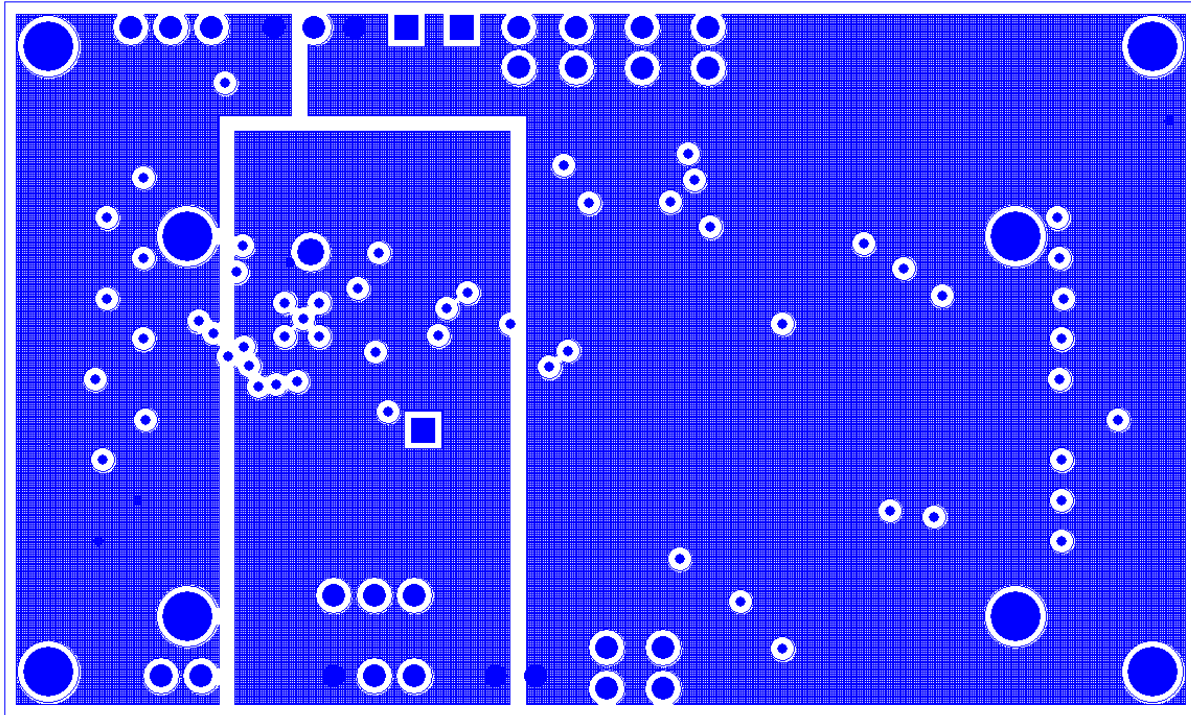

Figure 9: 73S8009C Demo Board: Middle Layer 2, Supply Plane

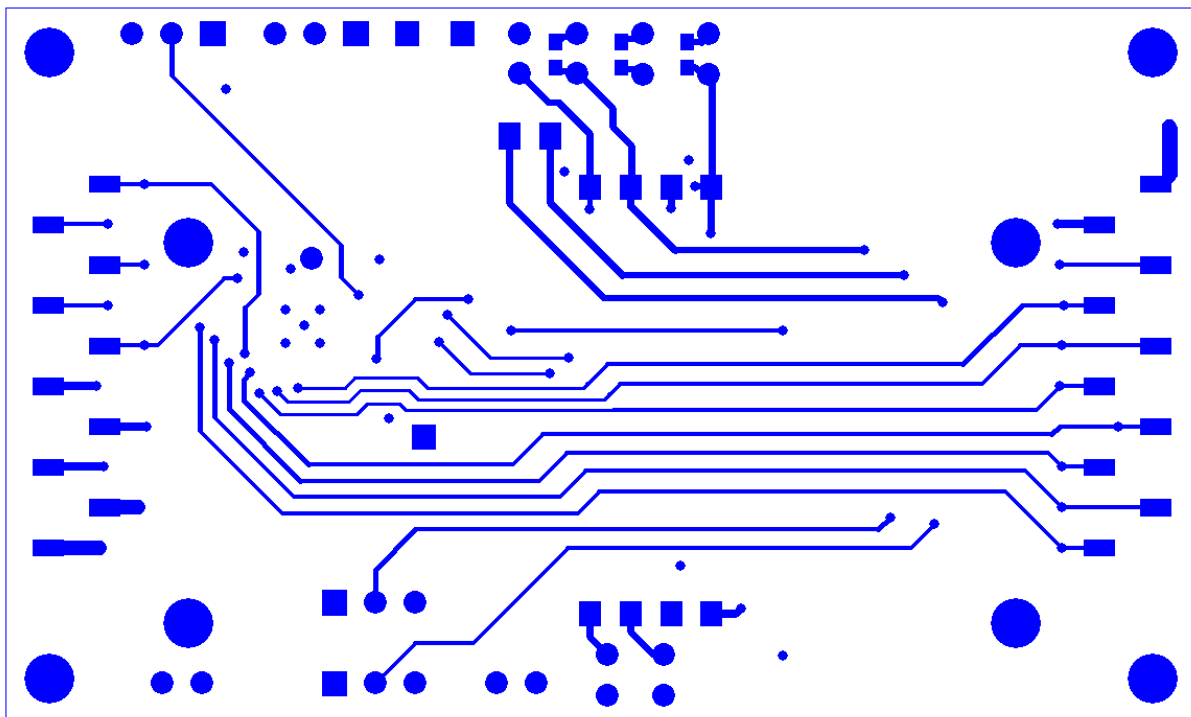

Figure 10: 73S8009C Demo Board: Bottom Signal Layer

### 5.3 73S8009C Demo Board Bill of Materials

Table 6: 73S8009C Demo Board Bill of Materials

Qnt	Reference	Part	PCB Footprint	Digikey Part Number	Part Number	Manufacturer
1	C1	10 $\mu$ F	805	PCC2225CT-ND	ECJ-2FB0J106M	Panasonic
2	C2, C3	0.1 $\mu$ F	603	PCC1762CT-ND	ECJ-1VB1C104K	Panasonic
1	C4	4.7 $\mu$ F	603	PCC2396CT-ND	ECJ-1VB0J475K	Panasonic
2	C9, C12	27 pF	603	PCC270ACVCT-ND	ECJ-1VC1H270J	Panasonic
1	C11	0.47 $\mu$ F	603	PCC2275CT-ND	ECJ-1VB0J475K	Panasonic
4	JP2, JP3, JP5, JP6	Header 3	3pins, 2.54mm pitch	S1011E-36-ND	PBC36SAAN	Sullins
2	JP4, JP7	Header 2	2pins, 2.54mm pitch	S1011E-36-ND	PBC36SAAN	Sullins
2	J1, J3	SSM_110_L_SV	SSM_110_L_SV	X	SSM_110_L_SV	Samtec
2	J2, J4	TSM_110_01_L_SV	TSM_110_01_L_SV	X	TSM_110_01_L_SV	Samtec
1	J5	Smart Card Connector	ITT_CCM02-2504	401-1715-ND	CCM02-2504LFT	ITTCannon
1	J6	SIM/SAM Connector	ITT_CCM03-3754	CCM03-3754CT-ND	CCM03-3754	ITTCannon
1	L1	Inductor		445-1998-1-ND	SLF7032T-100M1R4-2-PF	TDK
2	R7	0	603	P0.0GCT-ND	ERJ-3GEY0R00V	Panasonic
1	S1	Switch	Panasonic EVQ	P8051SCT	EVQ-PJX05M	Panasonic
8	TP1, TP2, TP3, TP4, TP5, TP6, TP7, TP8	TP	2X1_Header	S1011E-36-ND	PBC36SAAN	Sullins
1	U1	73S8009C	32QFN	X	73S8009C	Teridian

Note: The resistors noted Ru and Rd in the schematic are not populated on the board. They can be implemented to adjust the features of the smart card reader.

## 6 Errata

The 73S8009C Demo Board contains a silk screen error on JP6. The VDD and GND are reversed and have corrective decals attached to show the proper labeling.

## 7 Ordering Information

Table 7 lists the order number used to identify the 73S8009C Demo Board.

**Table 7: 73S8009C Demo Board Order Number**

Part Description	Order Number
73S8009C 32-Pin QFN Demo Board	73S8009C-DB

## 8 Related Documentation

The following 73S8009C documents are available from Teridian Semiconductor Corporation:

*73S8009C Data Sheet*

*73S8009C Demo Board User Manual*

## 9 Contact Information

For more information about Teridian Semiconductor products or to check the availability of the 73S8009C, contact us at:

6440 Oak Canyon Road  
Suite 100  
Irvine, CA 92618-5201

Telephone: (714) 508-8800  
FAX: (714) 508-8878  
Email: [scr.support@teridian.com](mailto:scr.support@teridian.com)

For a complete list of worldwide sales offices, go to <http://www.teridian.com>.

## Revision History

Revision	Date	Description
1.0	5/22/2007	First publication.
1.1	8/9/2007	Corrected schematic error.
1.2	9/6/2007	Corrected pin number for OFF_ACK in pin description.
1.3	2/10/2010	Formatted in the new Teridian style. Added Section 1.1, Package Contents. Added Section 1.2, Safety and ESD Notes. Added Table 3: J4 Pin Descriptions. Added Table 4: J2 Pin Descriptions. Added Section 7, Ordering Information. Added Section 8, Related Documentation. Added Section 9, Contact Information. Miscellaneous editorial corrections.