

Evaluation Board for the ADP1850SP Step-Down DC-to-DC Controller

FEATURES

- Input range: 10 V to 20 V**
- Two output voltages: 3.3 V and 1.8 V**
- Output current: 14 A per channel**
- Switching frequency: 600 kHz**
- Operates in PWM or PSM**
- Compact, low cost, and efficient design**

EVALUATION BOARD DESCRIPTION

This document describes the design, operation, and test results of the ADP1850SP-EVALZ. The input range for this evaluation board is 10 V to 20 V, and the two regulated output voltages are set to 3.3 V (V_{OUT1}) and 1.8 V (V_{OUT2}) with a maximum 14 A output current. A switching frequency (f_{sw}) of 600 kHz is chosen to achieve a good balance between efficiency and the sizes of the power components.

ADP1850 DEVICE DESCRIPTION

The [ADP1850](#) is a dual-channel, step-down switching controller with integrated drivers for external N-channel synchronous

power MOSFETs. The two PWM outputs are phase shifted 180°, which reduces the input RMS ripple current, thus minimizing required input capacitance. The two outputs can be combined for dual-phase PWM operation that can deliver more than 50 A output current. The internal parameters of the two channels are optimized for current sharing.

In addition, boost diodes are integrated into the ADP1850, thus lowering the overall system cost and component count. The ADP1850 can be set to operate in pulse skip, high efficiency mode under light load or in PWM continuous conduction mode.

The ADP1850 includes externally adjustable soft start, output overvoltage protection, externally adjustable current limit, power good, tracking function, and a programmable oscillator frequency that ranges from 200 kHz to 1.5 MHz. The ADP1850 provides an output voltage accuracy of $\pm 0.85\%$ from -40°C to $+85^{\circ}\text{C}$ and $\pm 1.5\%$ from -40°C to $+125^{\circ}\text{C}$ junction temperature. This controller can be powered from a 2.75 V to 20 V supply and is available in a 32-lead 5 mm \times 5 mm LFCSP package.

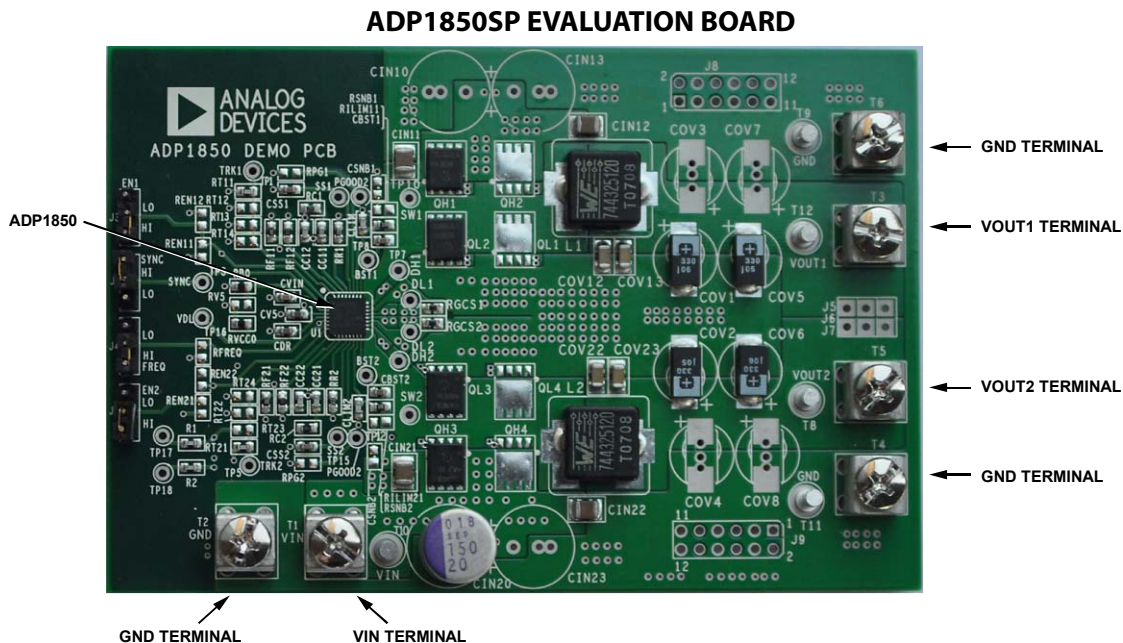

Figure 1.

TABLE OF CONTENTS

Features	1	Output Capacitors	3
Evaluation Board Description.....	1	MOSFET Selection.....	3
ADP1850 Device Description.....	1	Test Results	4
ADP1850SP Evaluation Board.....	1	Evaluation Board Operating Instruction	5
Revision History	2	Other Information About the Evaluation Board PCB Layout.....	6
Component Design	3	Evaluation Board Schematics and Artwork	7
Inductor Selection	3	Ordering Information.....	11
Input Capacitors	3	Bill of Materials.....	11

REVISION HISTORY

8/11—Rev. 0 to Rev. A

Changes to Figure 2 and Figure 4.....	4
Changes to Table 3.....	11

11/10—Revision 0: Initial Version

COMPONENT DESIGN

For information about selecting power components and calculating component values, see the [ADP1850](#) data sheet.

INDUCTOR SELECTION

A 1.2 μH inductor with a 20 A average current rating (744325120 from Würth Elektronik) is selected. This is a compact inductor with a ferrite core, which offers high performance in terms of low R_{DC} and low core loss.

INPUT CAPACITORS

Because of the very low ESR and high input current rating of multilayer ceramic capacitors (MLCCs), two 10 μF MLCCs in Size 1210 are selected as the input capacitors at the input of each channel. In addition, a 150 μF bulk OS-CON™ (aluminum solid capacitor with conductive polymer) capacitor from Sanyo is chosen for filtering out any unwanted low-frequency noise from the input power supply.

OUTPUT CAPACITORS

A combination of POSCAP™ polymer capacitors and MLCCs are selected for the output rails. Polymer capacitors have low ESR and high current ripple rating. Connecting polymer capacitors and MLCCs in parallel is very effective in reducing voltage ripple. Two 330 μF POSCAP capacitors and two 22 μF MLCCs are selected for each output.

MOSFET SELECTION

For low output or low duty cycle, select a high-side MOSFET with fast rise and fall times and with low input capacitance to minimize charging and switching power loss. As for the synchronous rectifier (low-side MOSFET), select a MOSFET with low $R_{\text{DS(on)}}$ because the switching speed is not critical and there is no switching power loss in the low-side MOSFET.

For the high-side MOSFET, the BSC080N03LS from Infineon Technologies in the PG-TDSON-8 or Super-SO8 package is selected. This part has low input capacitance (1.2 nF) and fast transition times (3 ns). For the low-side MOSFET, the BSC030N03LS, with $R_{\text{DS(on)}}$ of 4.7 m Ω at a V_{GS} of 4.5 V, is selected.

TEST RESULTS

T_A = 25°C.

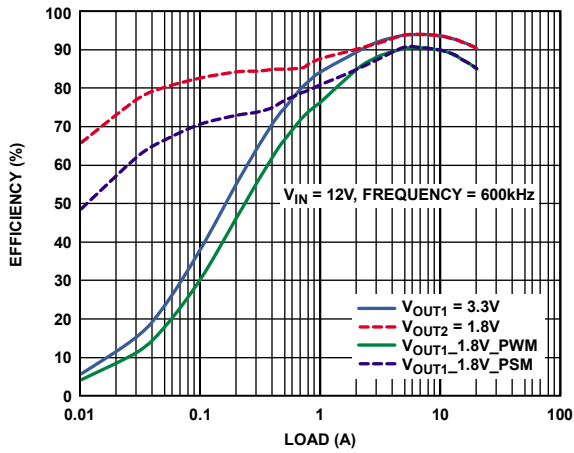

Figure 2. Efficiency (Measurement Is Made with the Adjacent Channel Disabled)

09455-002

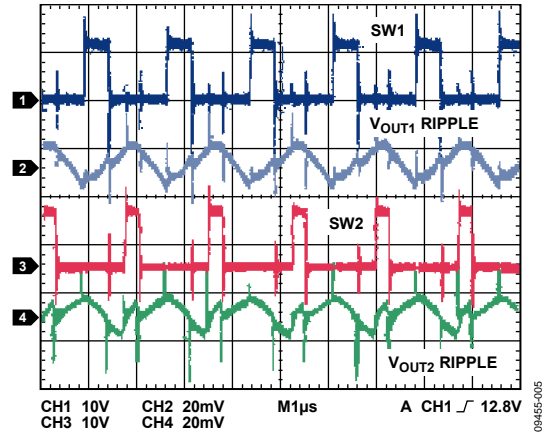

Figure 5. Output Ripple, 14 A Load

09455-005

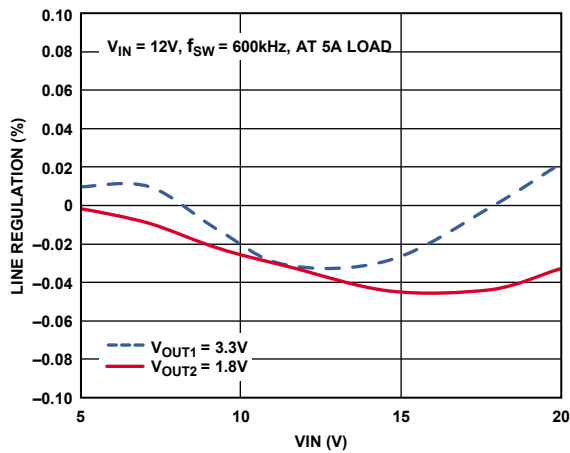

Figure 3. Line Regulation

09455-003

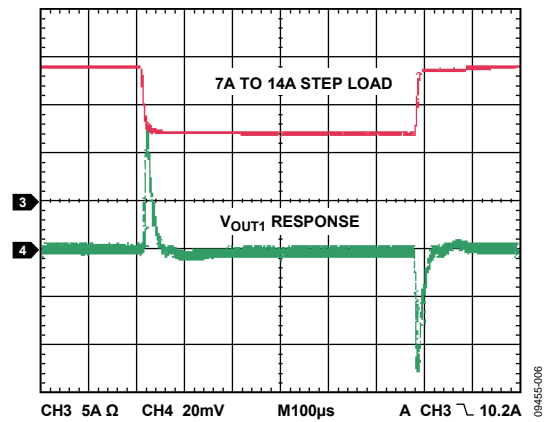

Figure 6. Step Load Transient, V_{OUT1}

09455-006

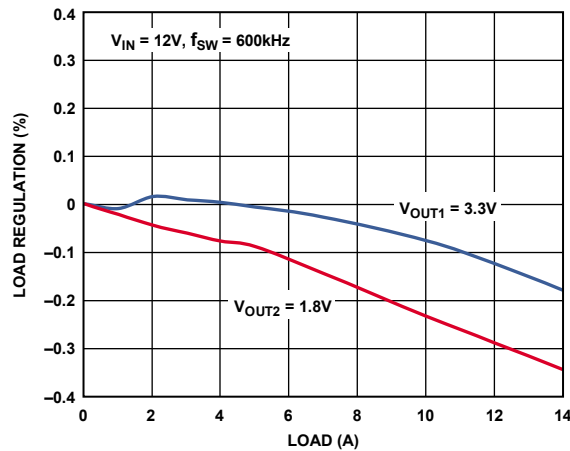

Figure 4. Load Regulation

09455-004

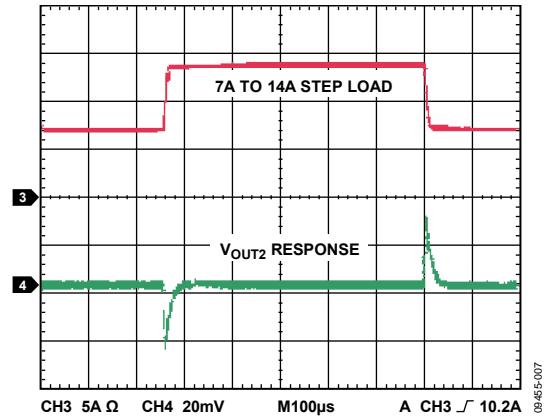

Figure 7. Step Load Transient, V_{OUT2}

09455-007

EVALUATION BOARD OPERATING INSTRUCTION

1. Connect Jumper J3 (EN1) to the high position to enable Channel 1 of the ADP1850.
2. Connect Jumper J2 (EN2) to the high position to enable Channel 2 of the ADP1850.
3. Connect Jumper J4 (FREQ) to the high position for 600 kHz operation.
4. Connect Jumper J1 (SYNC) to the high position for PWM operation or to low for PSM operation.
5. Connect the positive terminal of the input power supply to the input terminal, T1. The input range is 10 V to 20 V.

Table 1. Jumper Description

Jumper	Description	Default Factory Setting	Function
J1	SYNC	High	Connect high for PWM or low for PSM operation. For synchronization, run an external clock source to this pin.
J2	EN2	High	Connect high to enable Channel 2 of the ADP1850 or low to disable the channel.
J3	EN1	High	Connect high to enable Channel 1 of the ADP1850 or low to disable the channel.
J4	FREQ	High	Connect low for 300 kHz or high for 600 kHz operation. This 14 A evaluation board is configured for operation at 600 kHz. Connect J4 high.

Table 2. Performance Summary ($T_A = 25^\circ\text{C}$)

Parameter	Condition
V_{IN}	10 V to 20 V
f_{SW}	Switching frequency, 600 kHz
V_{OUT1}	3.3 V
I_{OUT1}	0 A to 14 A
V_{OUT1} Ripple, DC Load	18 mV at 14 A load
V_{OUT1} Deviation upon Step Load Release	1.5% with a 7 A step load
V_{OUT2}	1.8 V
I_{OUT2}	0 A to 14 A
V_{OUT2} Ripple, DC Load	18 mV at 14 A load
V_{OUT2} Deviation upon Step Load Release	1.8% with a 7 A step load

OTHER INFORMATION ABOUT THE EVALUATION BOARD PCB LAYOUT

As seen in Figure 1, the layout of this evaluation board is not optimized for the smallest PCB area. It is laid out in such a way that any of the components can be desoldered and replaced easily with different components with a hand soldering iron so that the user can modify the existing design without acquiring a new PCB layout. The physical size of the compensation components is 0603, which is selected for its ease of hand soldering when reworking the board is needed. The size of these components can be 0402 or even smaller in the final design. Note that there are extra place holders for input bulk capacitors, output filter capacitors, and MOSFETs. The user can remove, add, or change any of these power components to achieve a particular design objective. The track functions,

where TRK1 and TRK2 are pulled up to VCCO through 0 Ω dummy resistors, are not used on this evaluation board. If a tracking function is needed, the user can remove the 0 Ω dummy resistors and add external resistive components to obtain the desired tracking function. Dummy 0 Ω resistors are placed at the driver gates, DHx and DLx, for evaluation purpose only and can be removed in the final design. Also, the configuration of this evaluation board can be modified to obtain a single output dual-phase operation. Furthermore, many test points are placed on the evaluation board so that the user can easily evaluate the performances of the [ADP1850](#) with an oscilloscope. See Figure 8, the evaluation board schematic, for more information.

EVALUATION BOARD SCHEMATICS AND ARTWORK

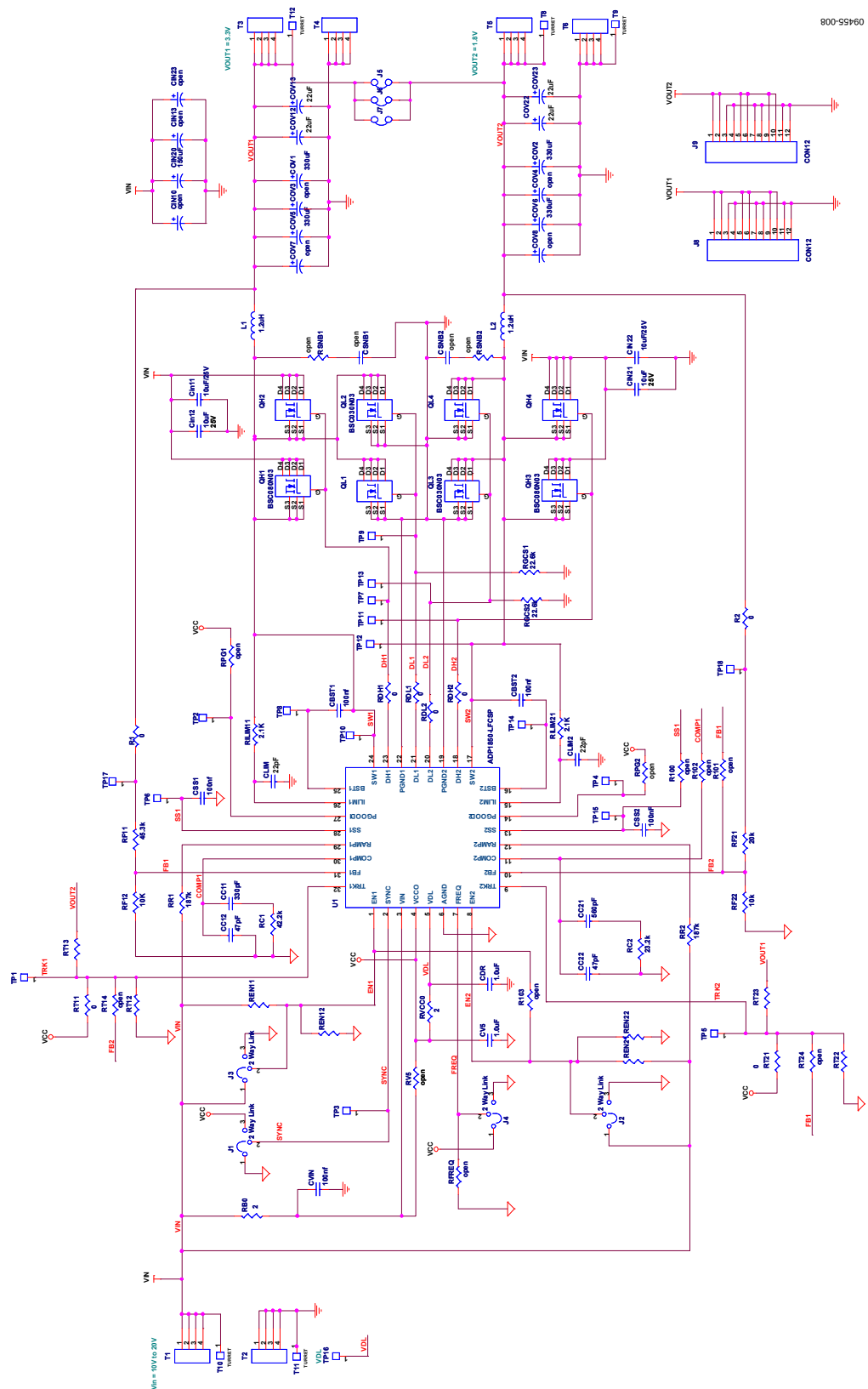

Figure 8. Evaluation Board Schematic

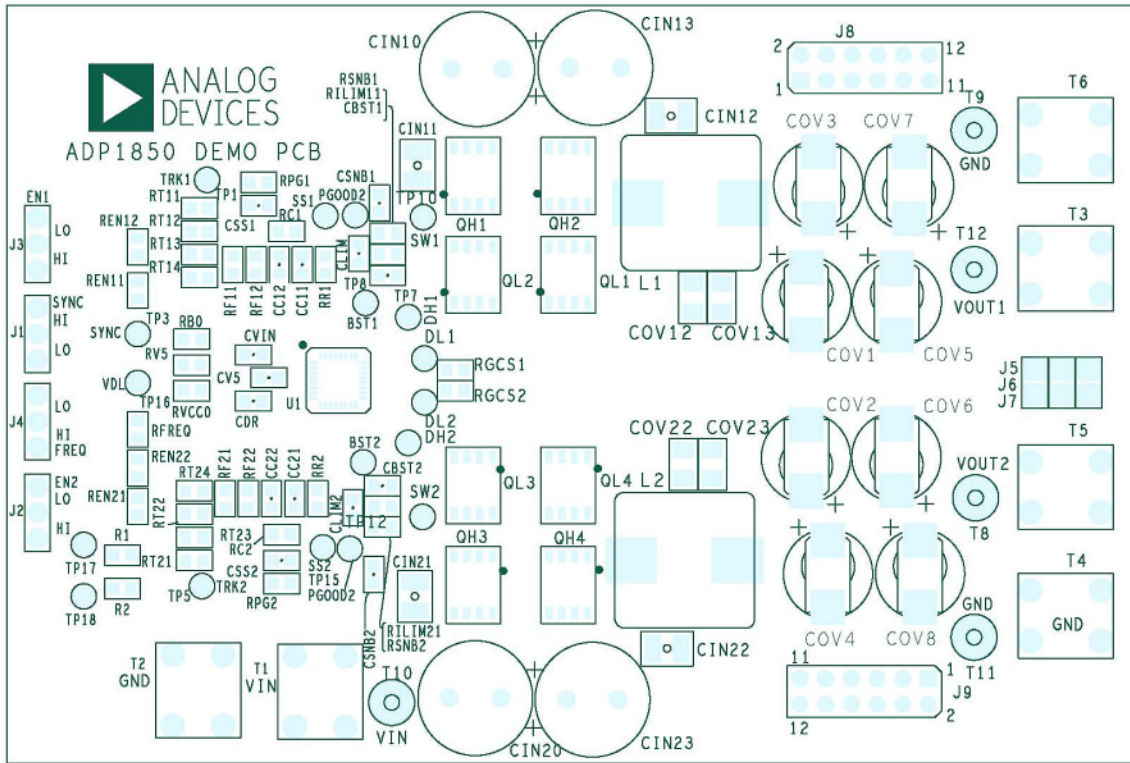

Figure 9. Top Silkscreen

09455-009

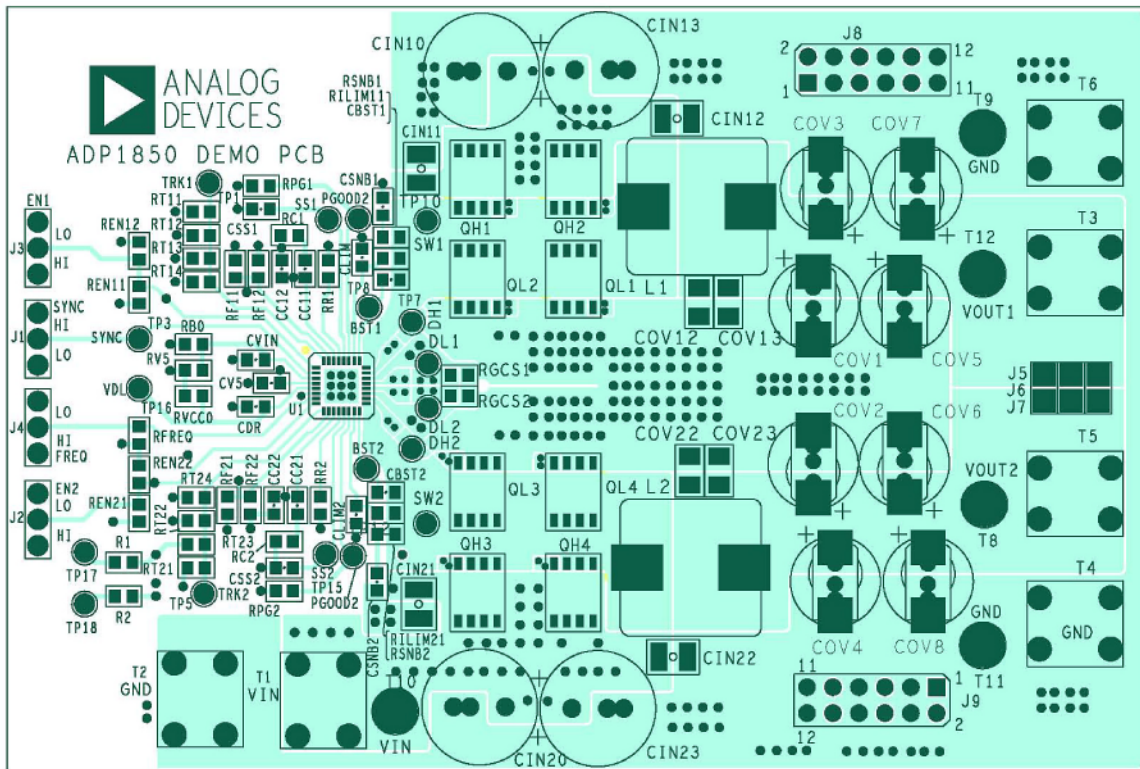
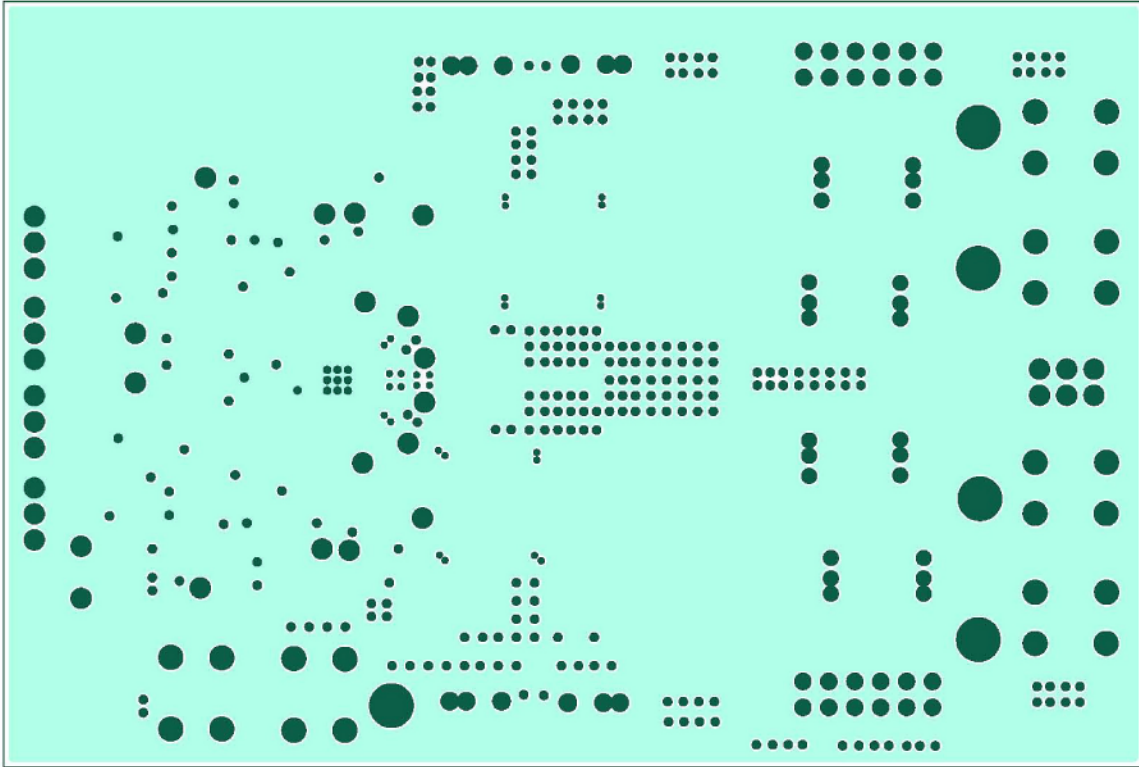

Figure 10. Top Layer

09455-010



09455-011

Figure 11. Second Layer (AGND Plane)

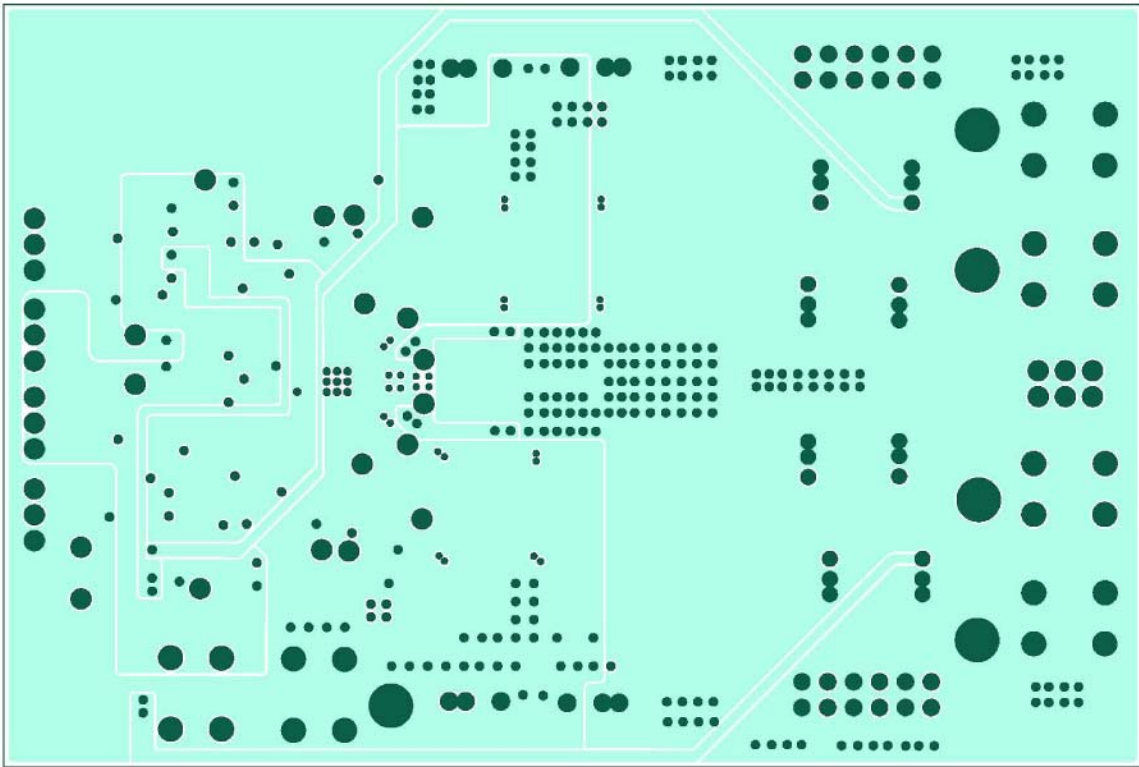

09455-012

Figure 12. Third Layer (PGND Layer)

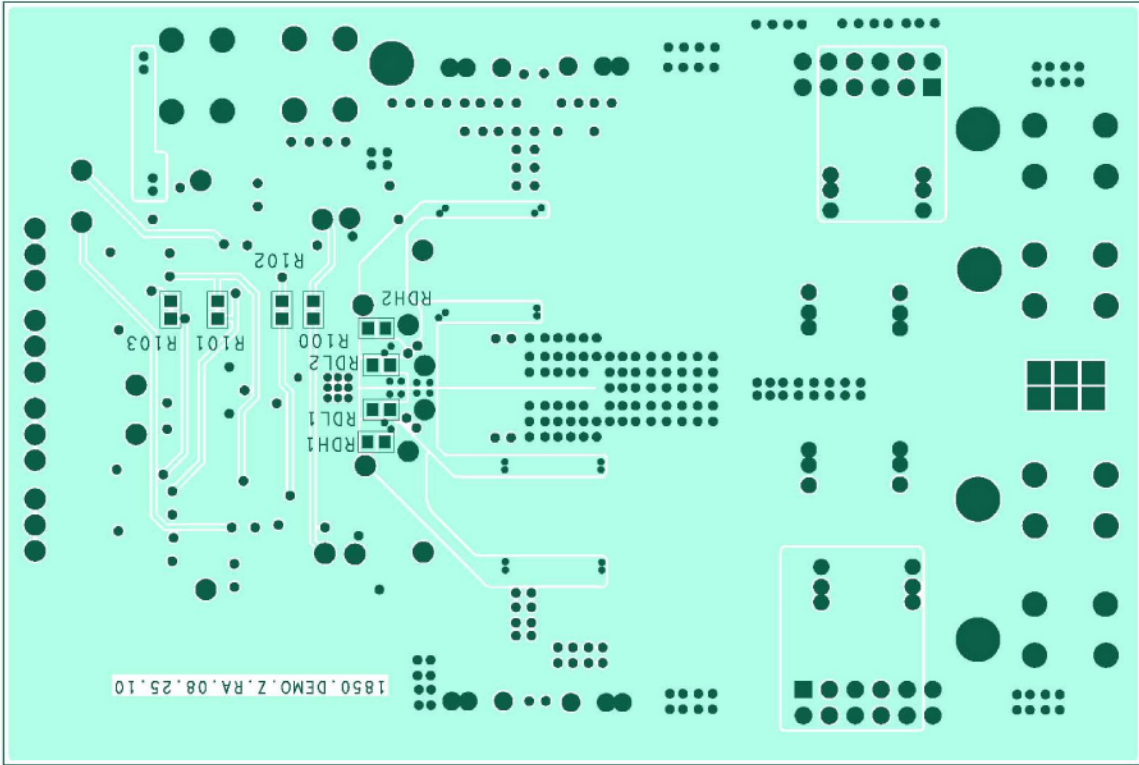

09455-013

Figure 13. Bottom Layer (PGND Layer)

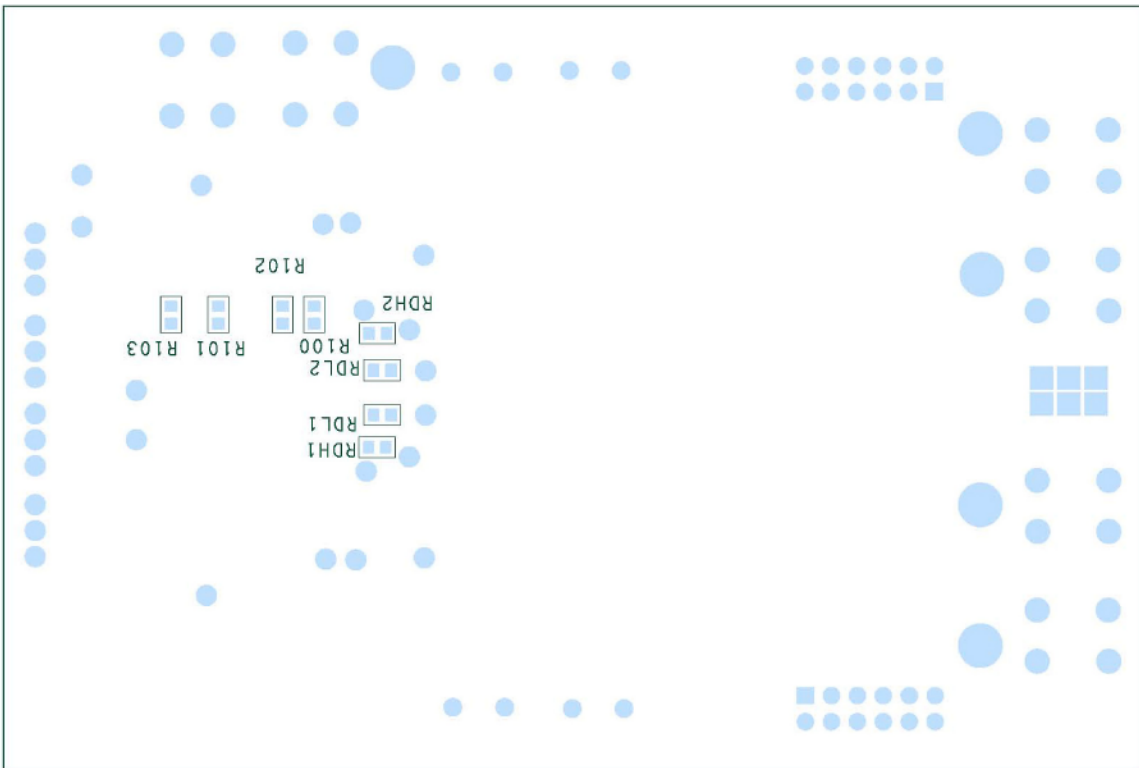

09455-014

Figure 14. Bottom Silk Screen

ORDERING INFORMATION

BILL OF MATERIALS

Table 3.

Qty	Reference Designator	Description	Manufacturer	Part No.
1	U1	Device under test, LFCSP	Analog Devices	ADP1850
1	CIN20	OS-CON, 150 μ F, 20 V	Sanyo	20SEP150M
4	CIN11, CIN12, CIN21, CIN22	Input capacitor MLCC, 10 μ F, X7R, 25 V, 1210	Murata	GRM32DR71E106KA12
5	CSS1, CSS2, CBST1, CBST2, CVIN	Input capacitor MLCC, 100 nF, X7R, 25 V, 0603	Murata	GRM188R71E104KA01
2	CV5, CDR	Input capacitor MLCC, 1.0 μ F, X5R, 6.3 V, 0603	Murata	GRM185R60J105KE21
2	RB0, RVCCO	Resistor, 2 Ω , 0603	Vishay	CRCW06032R00F
2	RGCS1, RGCS2	Resistor, 22.6 k Ω , 0603	Vishay	CRCW06032262F
2	RR1, RR2	Resistor, 187 k Ω , 0603	Vishay	CRCW06031873F
4	COV1 COV11, COV2, COV21	POSCAP, 330 μ F, 6.3 V, 18 m Ω	Sanyo	6TPE330MFL
4	COV12, COV13, COV22, COV23	MLCC, 22 μ F, X5R, 1206	Murata	GRM31CR60J226ME19L
2	L1, L2	Inductor, 1.2 μ H, 1.8 m Ω , I _N = 20 A, I _{SAT} = 25 A	Würth Elektronik	744325120
2	RF22, RF12	Resistor, 10 k Ω , 0603	Vishay	CRCW06031002F
1	RF21	Resistor, 20 k Ω , 0603	Vishay	CRCW06032002F
1	RF11	Resistor, 45.3 k Ω , 0603	Vishay	CRCW06034532F
8	RDH1, RDH2, RDL1, RDL2, Rt11, Rt21, R1, R2	Resistor, 0 Ω , 0603	Vishay	CRCW06030R00F
2	QH1, QH3	N MOSFET, 30 V, 9 m Ω , super-SO8	Infineon	BSC080N03LS
2	QL2, QL3	N MOSFET, 30 V, 4.5 m Ω , super-SO8	Infineon	BSC030N03LS
1	CC11	MLCC, 330 pF, 0603	Vishay	VJ0603Y331KXAA
1	CC21	MLCC, 560 pF, 0603	Vishay	VJ0603Y561KXAA
2	CC12, CC22	MLCC, 47 pF, 0603	Vishay	VJ0603A470KXAA
1	RC1	Resistor, 42.2 k Ω , 0603	Vishay	CRCW06034222F
1	RC2	Resistor, 23.2 k Ω , 0603	Vishay	CRCW06032322F
2	RLIM11, RLIM21	Resistor, 2.1 k Ω , 0603	Vishay	CRCW06032101F
2	CLIM, CLIM2	MLCC, 22 pF, 0603	Vishay	VJ0603A220KXAA
4	J1, J2, J3, J4	3-terminal jumpers, 0.1 inch Spacing	Any	
5	T8, T9, T10, T11, T12	Test points, 110 mil through hole	Keystone Electronics Corp.	1502-1
6	T1, T2, T3, T4, T5, T6	Terminals	Keystone Electronics Corp.	8191

NOTES

**ESD Caution**

ESD (electrostatic discharge) sensitive device. Charged devices and circuit boards can discharge without detection. Although this product features patented or proprietary protection circuitry, damage may occur on devices subjected to high energy ESD. Therefore, proper ESD precautions should be taken to avoid performance degradation or loss of functionality.

Legal Terms and Conditions

By using the evaluation board discussed herein (together with any tools, components documentation or support materials, the "Evaluation Board"), you are agreeing to be bound by the terms and conditions set forth below ("Agreement") unless you have purchased the Evaluation Board, in which case the Analog Devices Standard Terms and Conditions of Sale shall govern. Do not use the Evaluation Board until you have read and agreed to the Agreement. Your use of the Evaluation Board shall signify your acceptance of the Agreement. This Agreement is made by and between you ("Customer") and Analog Devices, Inc. ("ADI"), with its principal place of business at One Technology Way, Norwood, MA 02062, USA. Subject to the terms and conditions of the Agreement, ADI hereby grants to Customer a free, limited, personal, temporary, non-exclusive, non-sublicensable, non-transferable license to use the Evaluation Board FOR EVALUATION PURPOSES ONLY. Customer understands and agrees that the Evaluation Board is provided for the sole and exclusive purpose referenced above, and agrees not to use the Evaluation Board for any other purpose. Furthermore, the license granted is expressly made subject to the following additional limitations: Customer shall not (i) rent, lease, display, sell, transfer, assign, sublicense, or distribute the Evaluation Board; and (ii) permit any Third Party to access the Evaluation Board. As used herein, the term "Third Party" includes any entity other than ADI, Customer, their employees, affiliates and in-house consultants. The Evaluation Board is NOT sold to Customer; all rights not expressly granted herein, including ownership of the Evaluation Board, are reserved by ADI. CONFIDENTIALITY. This Agreement and the Evaluation Board shall all be considered the confidential and proprietary information of ADI. Customer may not disclose or transfer any portion of the Evaluation Board to any other party for any reason. Upon discontinuation of use of the Evaluation Board or termination of this Agreement, Customer agrees to promptly return the Evaluation Board to ADI. ADDITIONAL RESTRICTIONS. Customer may not disassemble, decompile or reverse engineer chips on the Evaluation Board. Customer shall inform ADI of any occurred damages or any modifications or alterations it makes to the Evaluation Board, including but not limited to soldering or any other activity that affects the material content of the Evaluation Board. Modifications to the Evaluation Board must comply with applicable law, including but not limited to the RoHS Directive. TERMINATION. ADI may terminate this Agreement at any time upon giving written notice to Customer. Customer agrees to return to ADI the Evaluation Board at that time. LIMITATION OF LIABILITY. THE EVALUATION BOARD PROVIDED HEREUNDER IS PROVIDED "AS IS" AND ADI MAKES NO WARRANTIES OR REPRESENTATIONS OF ANY KIND WITH RESPECT TO IT. ADI SPECIFICALLY DISCLAIMS ANY REPRESENTATIONS, ENDORSEMENTS, GUARANTEES, OR WARRANTIES, EXPRESS OR IMPLIED, RELATED TO THE EVALUATION BOARD INCLUDING, BUT NOT LIMITED TO, THE IMPLIED WARRANTY OF MERCHANTABILITY, TITLE, FITNESS FOR A PARTICULAR PURPOSE OR NON-INFRINGEMENT OF INTELLECTUAL PROPERTY RIGHTS. IN NO EVENT WILL ADI AND ITS LICENSORS BE LIABLE FOR ANY INCIDENTAL, SPECIAL, INDIRECT, OR CONSEQUENTIAL DAMAGES RESULTING FROM CUSTOMER'S POSSESSION OR USE OF THE EVALUATION BOARD, INCLUDING BUT NOT LIMITED TO LOST PROFITS, DELAY COSTS, LABOR COSTS OR LOSS OF GOODWILL. ADI'S TOTAL LIABILITY FROM ANY AND ALL CAUSES SHALL BE LIMITED TO THE AMOUNT OF ONE HUNDRED US DOLLARS (\$100.00). EXPORT. Customer agrees that it will not directly or indirectly export the Evaluation Board to another country, and that it will comply with all applicable United States federal laws and regulations relating to exports. GOVERNING LAW. This Agreement shall be governed by and construed in accordance with the substantive laws of the Commonwealth of Massachusetts (excluding conflict of law rules). Any legal action regarding this Agreement will be heard in the state or federal courts having jurisdiction in Suffolk County, Massachusetts, and Customer hereby submits to the personal jurisdiction and venue of such courts. The United Nations Convention on Contracts for the International Sale of Goods shall not apply to this Agreement and is expressly disclaimed.