

**With built-in 'plug-and-play' functionality, Molex's Mobile TV Standard Antenna integrates LDS technology to eliminate the need for external attachments or active CMMB control chips**

As Chinese telecom operators gravitate toward CMMB (China Multimedia Mobile Broadcasting) - a home-grown audio/video coding standard for local broadcasting - domestic manufacturers in a number of promising electronic device sectors aggressively push for products that support this format.

An example of this is seen in the development of high-end mobile phones in the China market that enable handheld TV broadcasts over the wide 470 – 800MHz frequency range in CMMB format. Since not all phone makers develop their own hardware (baseband and RF chipsets) or even their own PCBs, they are only likely to have access to a 50-ohm input pin on the CMMB chip for a CMMB antenna signal (50 Ohm being the standard interface RF impedance). While this limitation may be overcome by attaching an external, retractable whip antenna to the device to enable CMMB-range reception, miniaturization trends toward slimmer and smaller phones preclude this option. Attempts to design an internal antenna reasonably small have met with challenges that include a narrow antenna bandwidth and poor radiation efficiency. Phone makers circumvent the CMMB bandwidth limitation using active circuits (example, RF switches) to make the antenna tunable to the desired frequency band. CMMB receiver chips are needed to generate control signals that make these 'active' antennas tunable; however, off-the-shelf CMMB receiver chips do not necessarily provide mobile makers with access to control signals and custom-designed CMMB chips are costly to implement.

Molex has developed an inexpensive, passive 'plug-and-play' antenna that can be integrated internally into any mobile device, supports the 470 – 800MHz UHF band and allows CMMB-based TV reception without the need for any active circuitry or frequency tuning. Fabricated from LDS technology, Molex's Mobile TV Standard Antenna comprises only a simple 50-ohm interface measuring 50.0 by 5.0 by 6.0mm (1.97 by 0.20 by 0.24") and features housing slots that help improve radiation efficiency as well as vertical ribs that reduce warpage during molding. With integral hooks at the sides, the antenna snaps into a matching set of apertures at the inner ends of the mobile device covers. These devices can include smartphones, tablet PCs, notebooks, netbooks, GPS devices with CMMB functionality as well as CMMB-enabled handheld devices.

The antenna requires a simple matching network and very minimum ground clearance from the edge of the PCB for optimal RF performance. The sleek design of the antenna helps maximize the layout area of the PCB it connects to, and reduces design cycle-time. In addition to providing engineering cost savings, the antenna is also RoHS-compliant and halogen-free.

For more information visit our website at:  
[www.molex.com/link/standard\\_antennas.html](http://www.molex.com/link/standard_antennas.html)

**Mobile TV Standard Antenna**  
**RoHS-compliant,**  
**Halogen-free**

**47951 Mobile TV Standard Antenna**

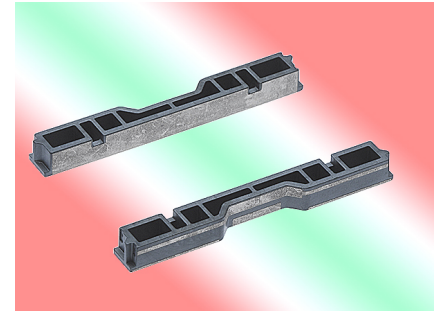

*Mobile TV Standard Antenna*

**FEATURES AND BENEFITS**

- Simple 50-ohm passive antenna interface provides complete CMMB band coverage without the need for costly active circuitry, switches or controls; reduces engineering costs with the simple interface between antenna and CMMB receiver
- Internal antenna design enhances mobile device appearance when integrated and eliminates concerns over durability and functionality of external antennas
- Specially-designed housing slots of the plastic housing features reduced antenna radiation loss
- Vertical ribs in housing reduces antenna warpage during molding
- Product is RoHS compliant and halogen-free for environmental sustainability

**SPECIFICATIONS**

**Reference Information**

Packaging: Tray  
 Use With: CMMB receiver  
 Designed In: mm  
 RoHS: Yes  
 Halogen Free: Yes  
 Glow Wire Compliant: No

**Electrical**

f\_start (MHz): 470  
 f\_end (MHz): 800  
 Return Loss S11 (dB): < -2  
 Total Efficiency at 470 MHz (dB): > -10 dB  
 Total Efficiency at 800 MHz (dB): > -5.9 dB  
 Polarization: Linear  
 Input Impedance (Ohms): 50

**Physical**

Housing Material: LCP Vectra E8401  
 Contact: Two SMD contact springs  
 Plating:  
 Contact Area — Nickel (Ni)  
 Underplating — Copper (Cu)  
 Operating Temperature: -30 to +75°C

## PRODUCT FEATURES

- Figure 1 shows the Mobile TV Standard Antenna fabricated with LDS technology
  - The antenna has Nickel (Ni) plating over Copper (Cu) underplate traces which connect to the PCB via a metallic c-clips (not shown)
  - The antenna body, made of LDS-grade LCP, is also known as the 'antenna carrier'
  - The antenna contact area (shown with the red rectangle) are contacted via pins 1 and 2 (respectively) to the source and ground inductors of the matching network
  - Its location-pin recesses orient and align the antenna such that the recesses match the position of the locating pins on the device cover
  - The hooks at the sides of the antenna snap into a matching set of apertures at the inner ends of the device cover, to secure the antenna into position

**Mobile TV Standard  
Antenna  
RoHS-compliant,  
Halogen-free**

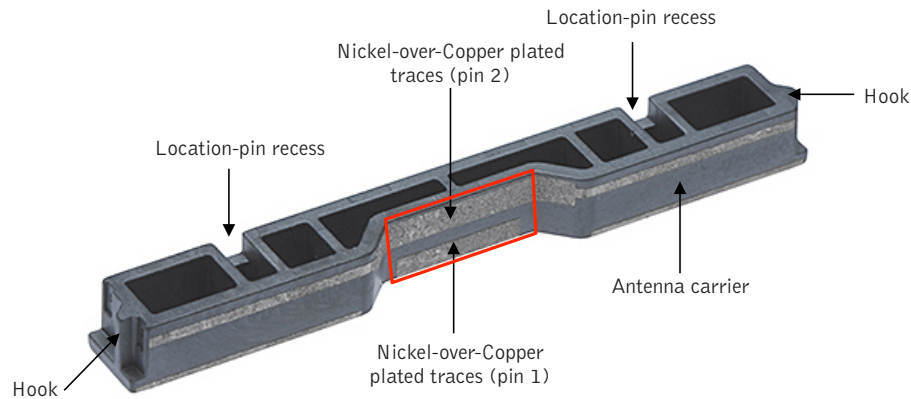

Figure 1. Design features of a Mobile TV Standard Antenna

- Figure 2 shows locating pins on the device cover that help orient and align the Mobile TV Standard Antenna during mounting. The hooks at the side of the antenna latch onto the side of the device cover, securing it precisely to the cover
- Figure 3 illustrates how easily the antenna integrates into the rear cover of the mobile device via a dual-locking mechanism. The antenna just 'snaps-into' the mobile device cover and is ready for use without the need for any active tuning

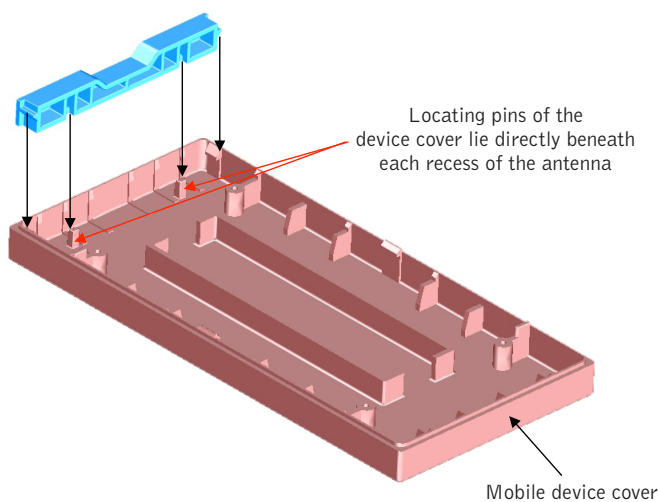

Figure 2. Alignment and interlocking features of the antenna and mobile device cover

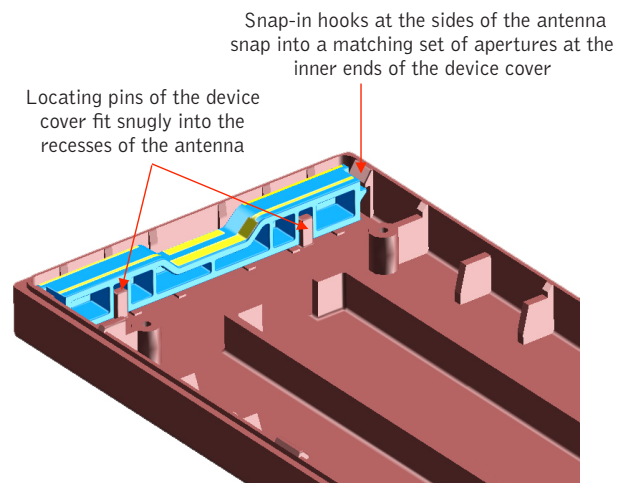

Figure 3. Easy integration of the Mobile TV Antenna into a mobile device cover

**Mobile TV Standard  
Antenna  
RoHS-compliant,  
Halogen-free**

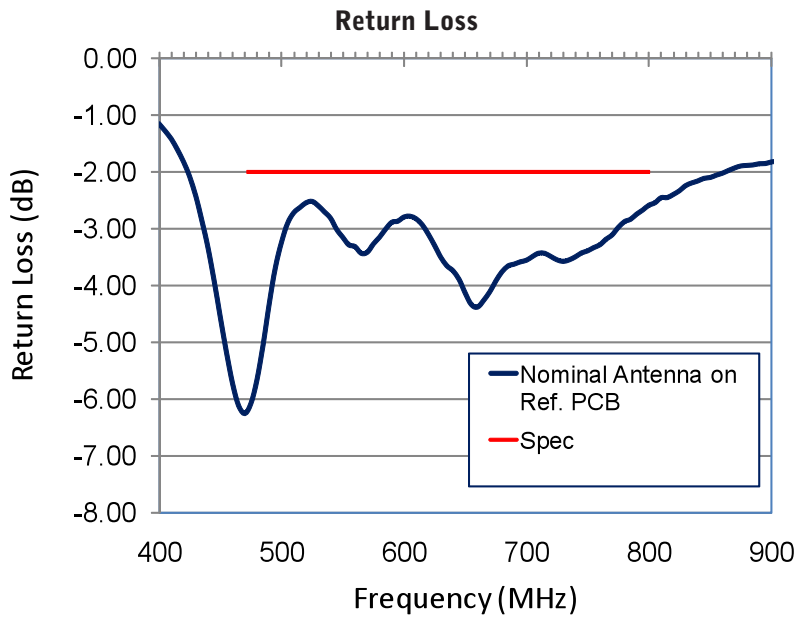

Figure 4: Return Loss (S11) measured on reference PCB with cover

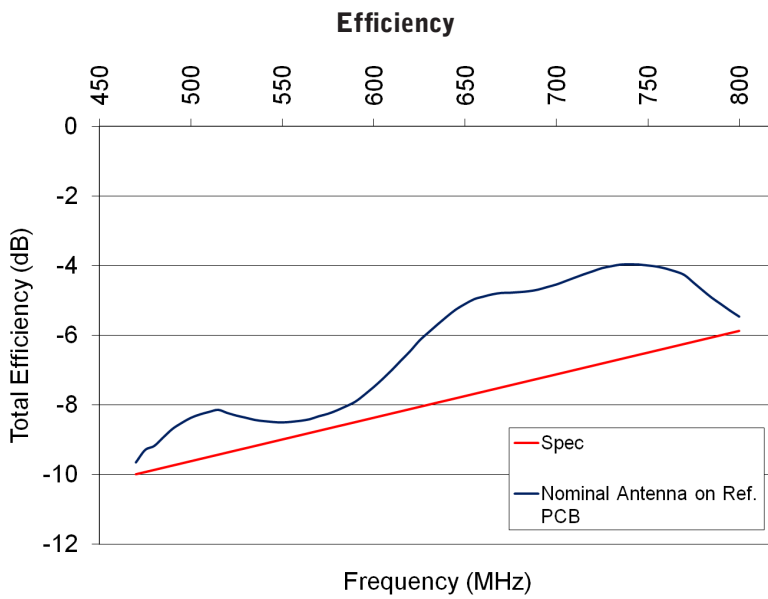

Figure 5: Total Efficiency (including Mismatch Loss) measured on reference PCB with cover

Mobile TV Standard  
Antenna  
RoHS-compliant,  
Halogen-free

Radiation Plots – 635MHz

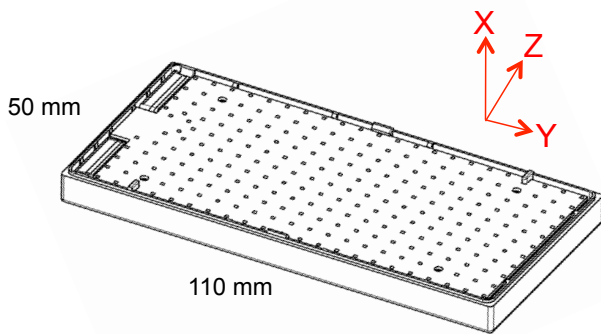

Figure 6a: Antenna on reference PCB with cover

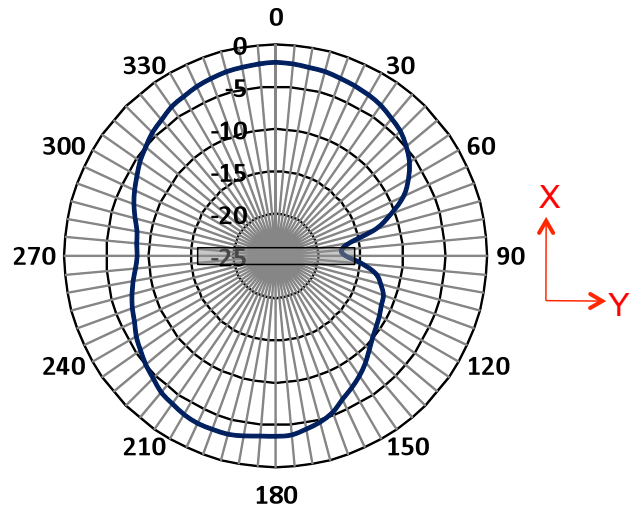

Figure 6b: Radiation diagram of X-Y plane shows combined polarizations at 635 MHz

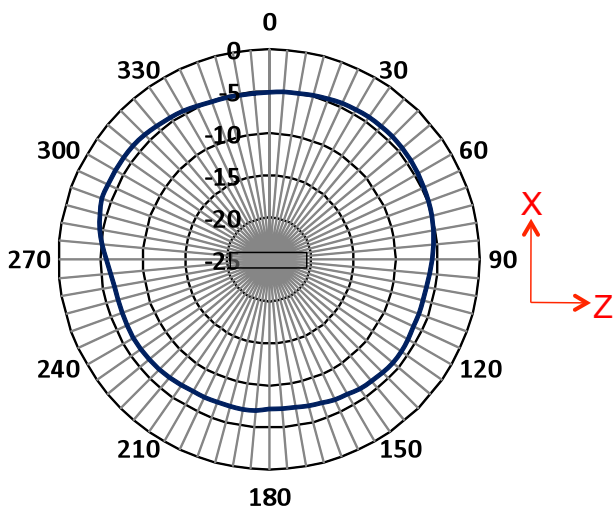

Figure 6c: Radiation diagram of X-Z plane shows combined polarizations at 635 MHz

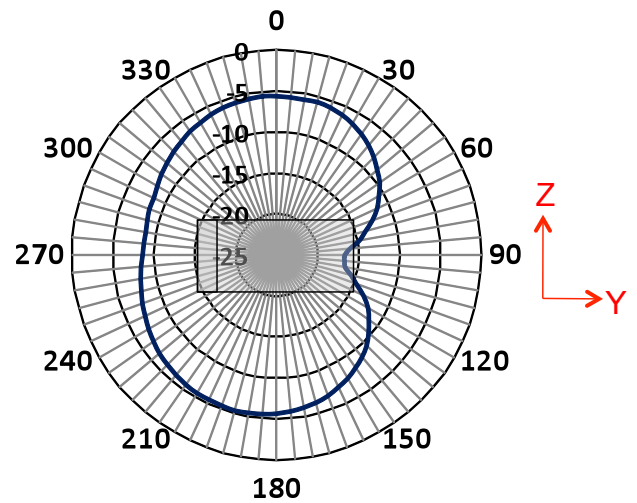

Figure 6d: Radiation diagram of Z-Y plane shows combined polarizations at 635 MHz

---

## APPLICATIONS

- Telecommunication Applications
  - Mobile phones
  - Smartphones
  - Tablet PCs
  - Notebooks and netbooks
- Other Markets
  - GPS navigation devices with CMMB functionality
  - Other CMMB-enabled devices



*Tablet PC*

**Mobile TV Standard  
Antenna  
RoHS-compliant,  
Halogen-free**



*Notebook PC*



*Mobile Phones and Smart Phones*



*CMMB-enabled device*

---

## ORDERING INFORMATION

Order No.	Description
47951-0001	Mobile TV Antenna, 50.00mm (1.97") Length, 50 Ohms, Snap Mount