

SPECIFICATIONS

(RoHS Compliant)



Model Number: MSD12K3E2X-E3

Version: 00

Part Number: 17001159A

Jun 12, 2018

Mechanical Drawing:

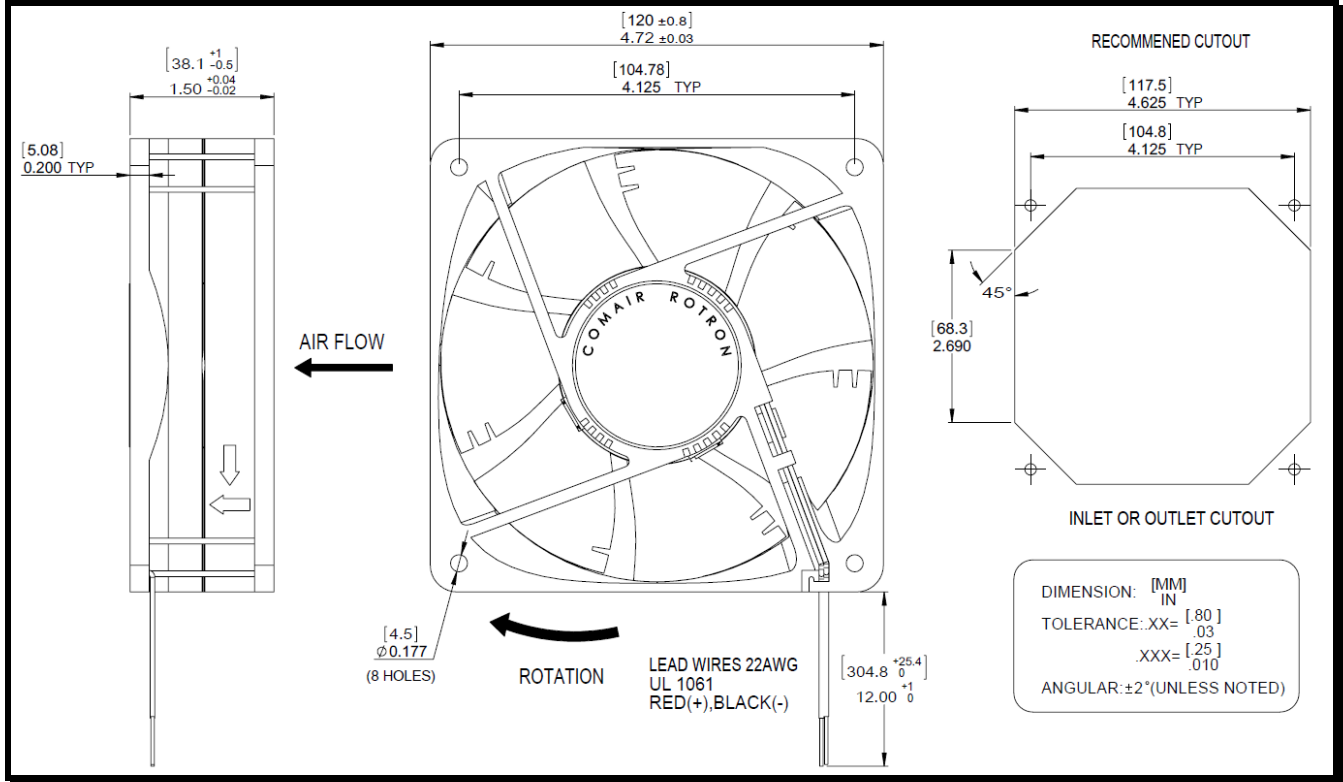

Motor:

Nominal Voltage	= 12 vdc
Operating Voltage Range	= 8 - 16 vdc
Nominal Running Current	= 0.92 amps
Max. Locked Rotor Current	= 2.2 amps
Running Power	= 11.0 watts
Average Speed	= 3400 RPM
Bearings	= Ball
Air Flow	= 120 CFM
Acoustic	= 51.8 dBA

Construction:

Venturi: Plastic, Black, UL 94V-0
 Propeller: Plastic, Black, UL 94V-0

Life Expectancy:

This fan is designed for continuous duty life of 45,000 hours at 70°C.

Termination:

12"±1"(304.8±25.4mm) 22AWG UL1061 Leadwires
 Red = Power(+)
 Black = Return(-)
 Blue/White = Tach output
 Yellow = PWM control

Additional Features:

Brushless DC Motor
 Automatic Restart Capability
 Electronic Locked Rotor Protection
 Polarity Protected
 Operating Temperature: -10°C to 70°C
 Storage Temperature: -40°C to 85°C
 Environmental Protection: Type 3(IP68)

TACHOMETER:

Output: Open Collector
 Ic: 20 mA max.
 Vcc: 32 Vdc max.
 Pulses per Revolution: 2
 Isolated: No

Speed Control:

PWM: 200 ~ 2 KHz, Open Collector
 <10% Duty: Off
 10%~95% Duty: Linear Ramp
 >95% Duty or Open Lead Wire: Full Speed

Agencies:

UL, CUL, CE

PQ Curve:

