

Compensated High Current Choke, 1-phase



Description

- Current compensated choke
- 1-phase choke
- THT-terminals
- Flange for mounting onto printed circuit board

Unique Selling Proposition

- Compact size and light weight
- Open design for optimal cooling
- Nanocrystalline or ferrite ring cores
- Customer specific pin outs available

Standards

- EN 60938
- UL 1283
- CSA 22.2 no 8

Approvals

- UL File Number: E72928
- ENEC File Number: 40043700

Applications

- Frequency converter
- Charge stations
- UPS-systems
- Switching power supplies

Weblinks

[pdf datasheet](#), [html-datasheet](#), [General Product Information](#), [Approvals](#), [CE declaration of conformity](#), [RoHS](#), [CHINA-RoHS](#), [REACH](#), [Distributor-Stock-Check](#), [Detailed request for product](#), [SPICE Library](#)

Technical Data

Rated voltage	IEC, UL: 300VAC	Test Voltage	2500VDC, 2sec, winding to winding	
	CSA: 250 VAC		Climatic Category	40/100/21 acc. to IEC 60068-1
	max. 425 VDC		Allowable Operation Temp.	-40°C to 100°C
Rated Current	10 - 50A @ Ta 40 °C			
Rated inductance	0.15 - 6.9mH, Tol. -30% +50%			
Power Operating Frequency	0 - 400Hz			
Terminal Type	THT			
Weight	30 - 115g			
Material: Housing	UL 94V-0			

Detailed information on product approvals, code requirements, usage instructions and detailed test conditions can be looked up in [General Product Information](#)

Dimension

37-10

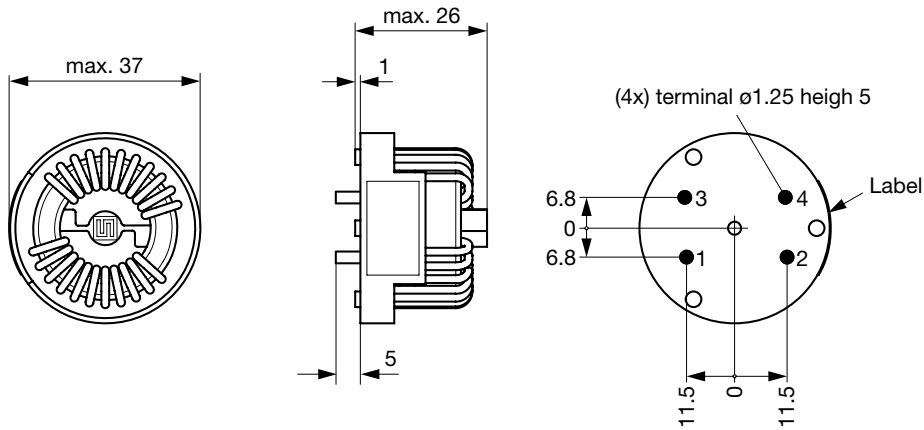

37-12

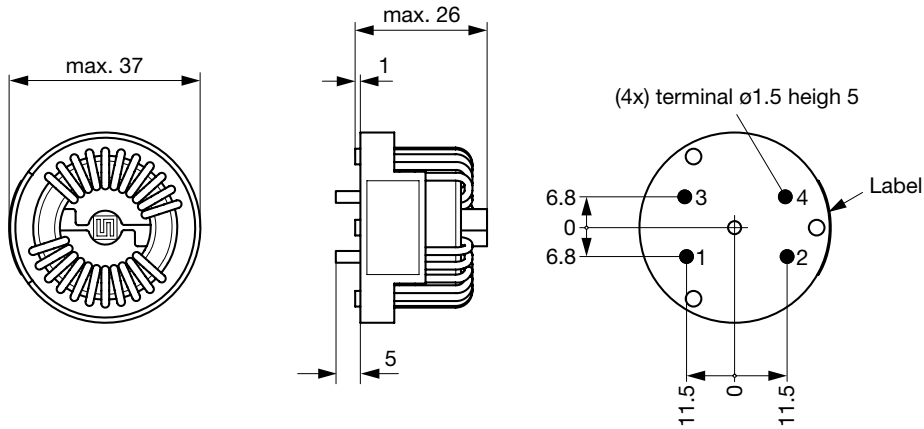

42-16

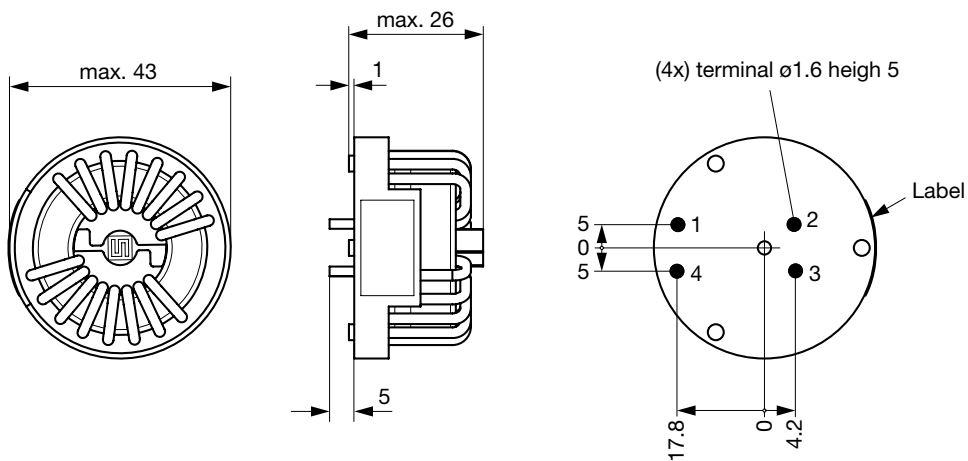

42-20

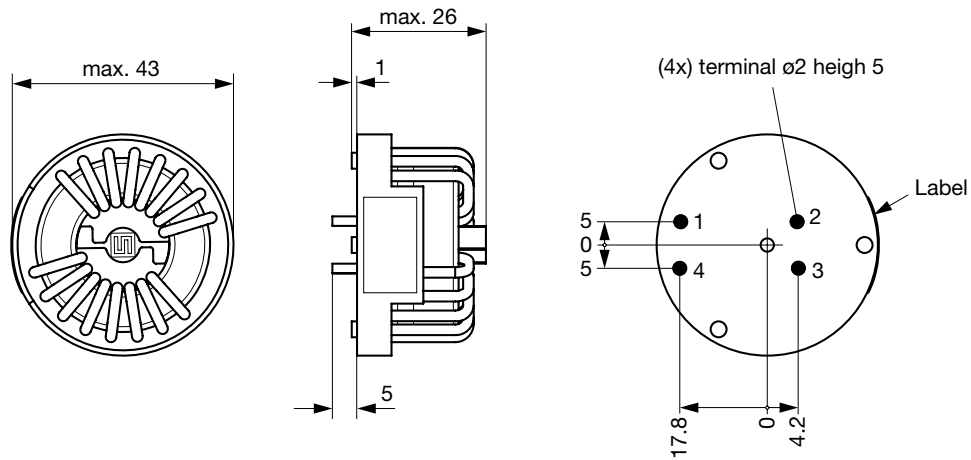

42-25

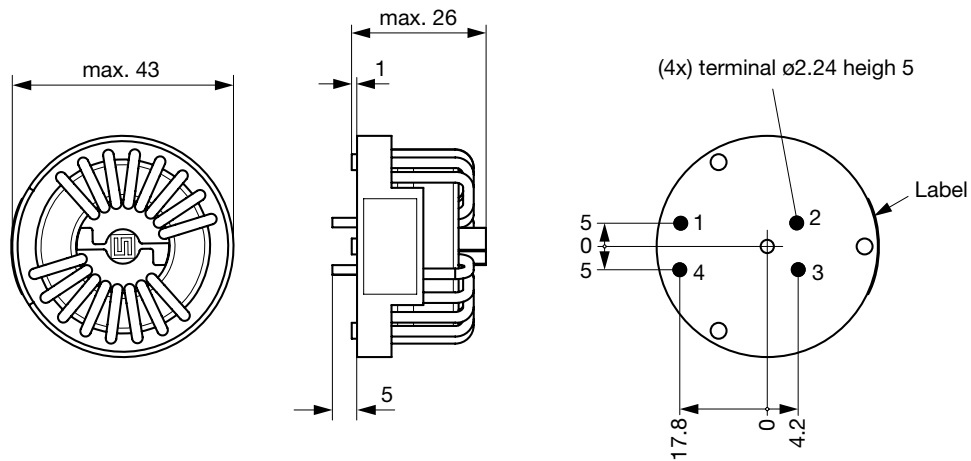

52-32

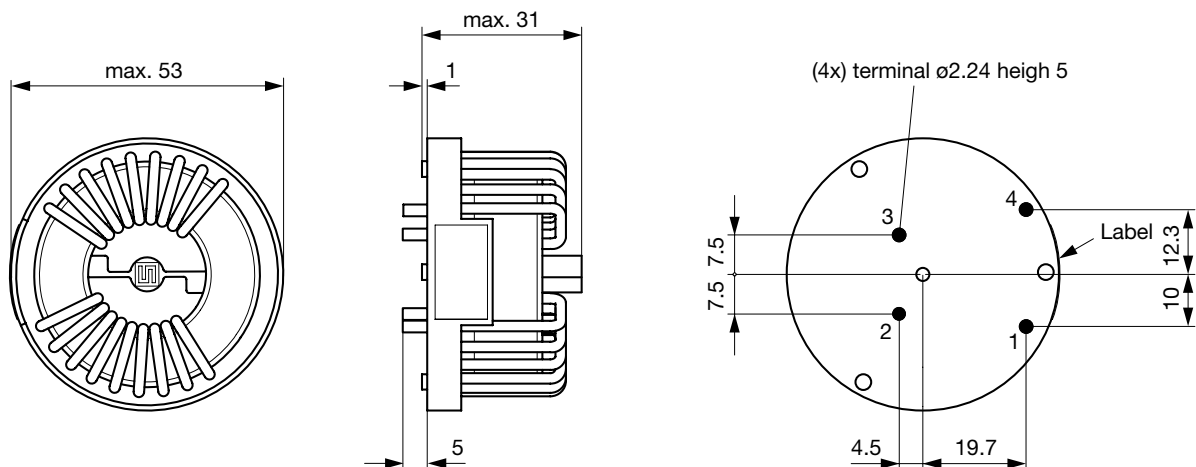

52-40

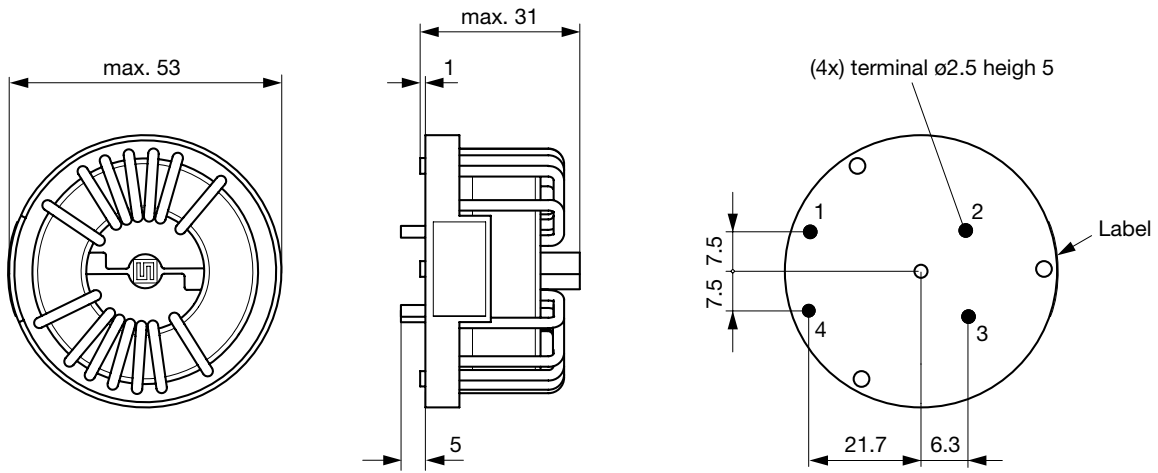

52-50

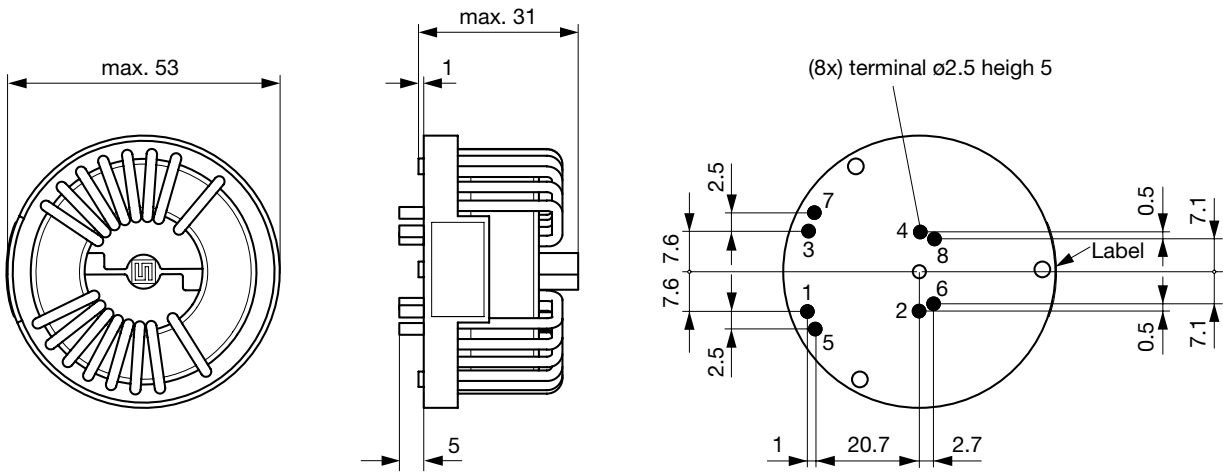

Diagrams

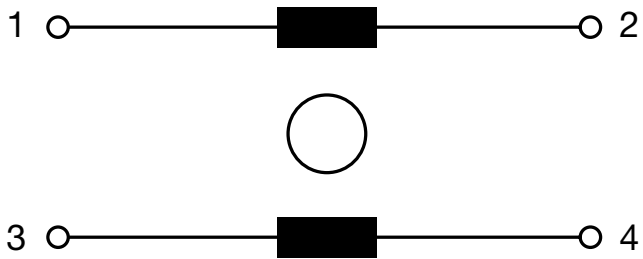

1 phase

Impedance curves

DKIH-3237-xxxx

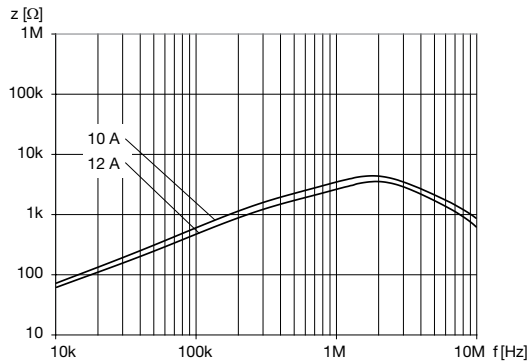

DKIH-3237-xxxx-NK

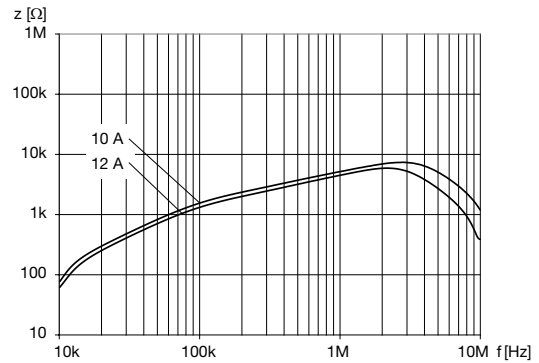

DKIH-3242-xxxx

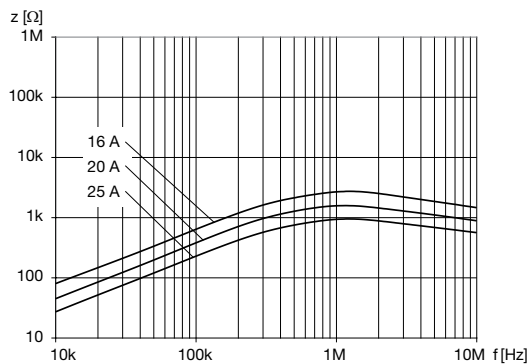

DKIH-3242-xxxx-NK

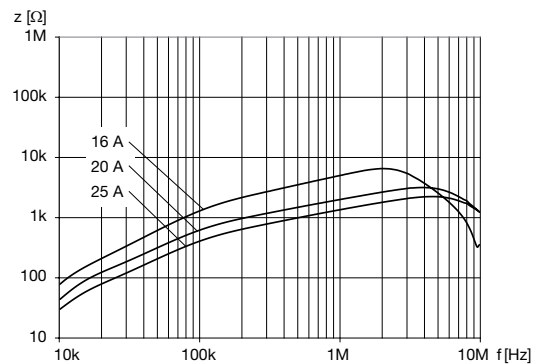

DKIH-3252-xxxx

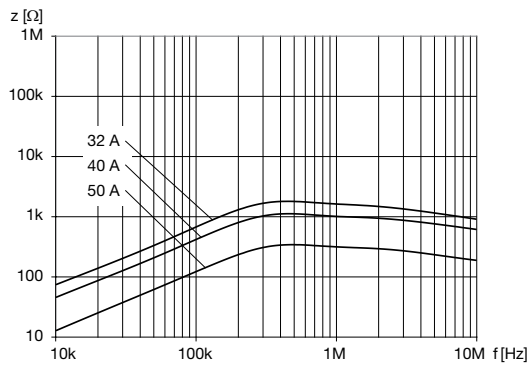

DKIH-3252-xxxx-NK

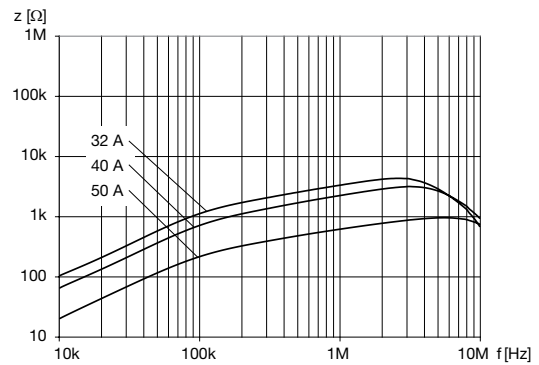

All Variants

I_n [A]	L_n [mH]	R_{cu} [m ²]	Power _{loss} [W]	f_{RES} [MHz]	Copper ϕ [mm]	Weight [g]	Housings	Packing unit [pcs.]	Order Number
10	6.9	10	2	2.2	1.25	30 g	37-10	40	DKIH-3237-1010-NK
10	0.8	10	2	2	1.25	30 g	37-10	40	DKIH-3237-10D8
12	6.8	7	2	2.5	1.5	40 g	37-12	40	DKIH-3237-1220-NK
12	0.7	7	2	2	1.5	40 g	37-12	40	DKIH-3237-12D7
16	6.9	5.6	2.9	2	1.6	45 g	42-16	20	DKIH-3242-160Q-NK
16	0.9	5.6	2.9	1.5	1.6	45 g	42-16	20	DKIH-3242-16D9
20	3.7	2.5	2	4	2	50 g	42-20	20	DKIH-3242-202M-NK
20	0.5	2.5	2	1.5	2	50 g	42-20	20	DKIH-3242-20D5
25	2.35	1.6	2	5	2.24	50 g	42-25	20	DKIH-3242-257K-NK
25	0.3	1.6	2	1.5	2.24	50 g	42-25	20	DKIH-3242-25D3
32	7.2	2.3	4.7	2.5	2.24	105 g	52-32	20	DKIH-3252-324Q-NK
32	0.75	2.3	4.7	0.4	2.24	105 g	52-32	20	DKIH-3252-32D8
40	4.3	1.5	4.8	3	2.5	115 g	52-40	20	DKIH-3252-409M-NK

I_n [A]	L_n [mH]	R_{Cu} [mΩ]	Power _{loss} [W]	f_{RES} [MHz]	Copper ø [mm]	Weight [g]	Housings	Packing unit [pcs.]	Order Number
40	0.45	1.5	4.8	0.4	2.5	115 g	52-40	20	DKIH-3252-40D5
50	1.4	0.5	2.5	6	2 x 2.5	115 g	52-50	20	DKIH-3252-506J-NK
50	0.15	0.5	2.5	0.4	2 x 2.5	115 g	52-50	20	DKIH-3252-50D2

Most Popular.

Availability for all products can be searched real-time: <http://www.schurter.com/en/Stock-Check/Stock-Check-SCHURTER>