

**DESCRIPTION**

The LXMG221D-0700040-D2F is a fully enclosed compact solid-state LED lighting driver module. It operates from a universal AC input supply in the range of 347V<sub>AC</sub> to 480V<sub>AC</sub>, 60Hz to drive a string of LEDs with active power factor correction. LED string voltage can range from 20V to 57V at a constant current of 700mA.

Control terminal leads include a dimming input BRITE A with a dedicated RETURN lead. The amplitude of the output LED string current will vary from 10% to 100% corresponding to a 1V<sub>DC</sub> to 10V<sub>DC</sub> signal on the BRITE A input following the 0V to 10V ESTA E1.3-2001 Analog Control Specification Standard. The BRITE A terminal when pulled down below minimum dimming will turn off the LEDs and enter a low power consumption mode. A second control terminal lead provides a FAULT indicator.

In the case that there is an LED string short between OUTPUT(+) and OUTPUT(-), or string open, or a product over temperature condition the FAULT terminal will go low. The FAULT terminal includes an open collector device that can be pulled up to a maximum of 60V and will sink 8mA typical to 0.8V when a short or open fault occurs.

To reduce audible noise the internal switching frequency remains above 30kHz. Safety features include open output circuit protection, whole string short circuit protection. The maximum allowable hot spot case temperature is 90°C (above this temperature the module will be thermally self-protected). The recommended operating ambient temperature range is -30°C to 70°C, as long as the maximum case temperature is not exceeded. The compact enclosure is rated to IP66, meets UL8750 and UL1310 class 2.

**KEY FEATURES**

- High Voltage AC Input: 347V<sub>AC</sub> to 480V<sub>AC</sub>
- High Efficiency
- Active Power Factor Correction
- Constant Current 700mA
- Dimming Input Provides 10% to 100% Range, Plus Shutdown
- Anode Supply Adjusts for String Voltage between 20V and 57V
- Small Compact Size
- Suitable for Damp Locations (IP66)
- UL8750 & UL1310
- UL File E337545
- FCC Class B
- Long Life Expectancy
- RoHS Compliant
- Full Protection: OVP, SCP, OTP, Maximum Power Limit
- Unique Fault Detection and Management

**APPLICATIONS**

Residential and Commercial LED Lighting Fixtures such as:

- LED Down Lights
- LED Street Lights

**IMPORTANT:** For the most current data, consult MICROSEMI's website: <http://www.microsemi.com>  
Patents Pending

**PRODUCT HIGHLIGHT**

Photo is representative only, actual product may differ slightly

**ORDER INFORMATION**

Part Number	Input Voltage	Output Current	Fault Output
LXMG221D-0700040-D2F	347V <sub>AC</sub> to 480V <sub>AC</sub> 60Hz	700mA Dimmable Current Source 20V to 57V Anode Voltage	Yes

**ABSOLUTE MAXIMUM RATINGS**

Input Voltage ( $V_{IN}$ ).....	0V <sub>AC</sub> to 528V <sub>AC</sub>
Input Power .....	50W (Internally Limited)
Input Frequency ( $V_{IN}$ ).....	57Hz to 63Hz
Peak Output LED String Current .....	810mA (Internally Limited)
Peak Output String Voltage .....	59.5V (Internally Limited)
Output Power .....	44W (Internally Limited)
Input Signal Voltage (BRITE A Input).....	-0.3V to greater of 10V or OUTPUT(+)
Output Signal Voltage (FAULT) .....	-0.3V to 60V
Cold Start Temperature.....	-30°C
Hot Spot Case Temperature, zero airflow .....	90°C
Storage Temperature Range .....	-40°C to 85°C

Note: Exceeding these ratings could cause damage to the device. All voltages are with respect to Ground. Currents are positive into, negative out of specified terminal.

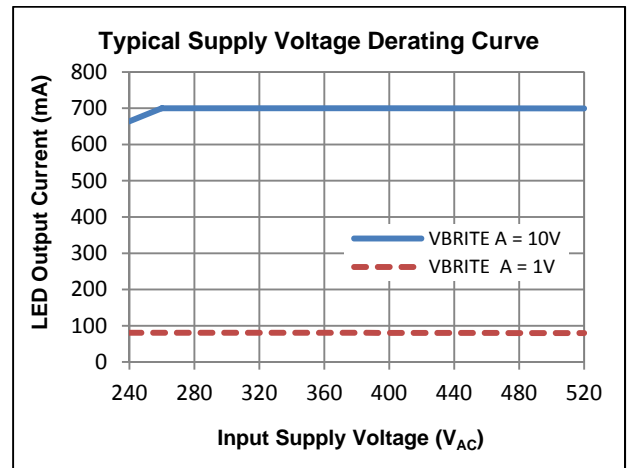
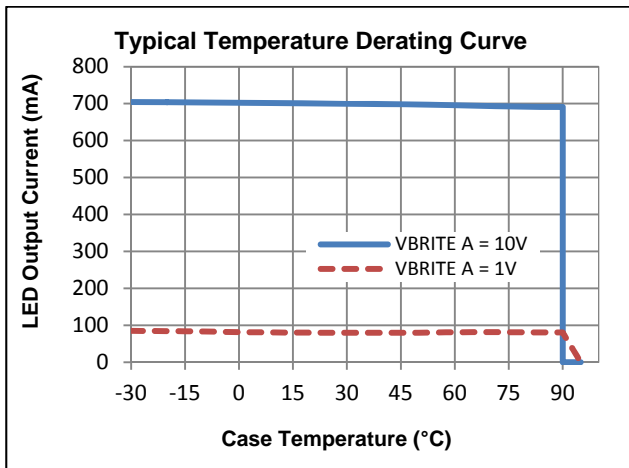
**RECOMMENDED OPERATING CONDITIONS (R.C.)**

This module has been designed to operate over a wide range of input and output conditions. However, best efficiency and performance will be obtained if the module is operated under the condition listed in the 'R.C.' column. Min. and Max. columns indicate values beyond which the inverter, although operational, might not function optimally.

Parameter	Symbol	Min	R.C.	Max	Units
Input Supply Voltage Range	$V_{IN}$	347		480	V <sub>AC</sub>
Linear BRITE A Control Input Voltage Range	$V_{BRITE A}$	0		10	V
Linear BRITE A Control PWM Frequency Range (Open Collector)	$V_{BRITE\_PWM}$	0.2		10	kHz
Linear BRITE A Control PWM Amplitude Range (Totem Pole)	$V_{BRITE\_PWM}$	10		$V_{OUTPUT(+)}$	V
Linear BRITE A Control PWM Frequency Range (Totem Pole)	$V_{BRITE\_PWM}$	0.2		25	kHz
LED String Voltage (at 700mA) <sup>1</sup>	$V_{LED}$	40 <sup>1)</sup>		57	V
OUTPUT(-) Sink Current	OUTPUT(-) <sub>ISINK</sub>		700		mA
Maximum Allowable Case Temperature	$T_C$			90	°C
Cold Start Temperature	$T_{COLD}$	-30			°C

1) Operation has been verified down to 20V, but it is recommended that low voltage performance with actual loading be verified by the user.



#### ELECTRICAL CHARACTERISTICS

Unless otherwise specified, the following specifications apply over the recommended operating condition except where otherwise noted;  $V_{IN} = 347V_{AC}$  to  $480V_{AC}$ , 60Hz; BRITE A =  $8k\Omega$  to RETURN; FAULT =  $1k\Omega$  pull up to 10V Full Load condition uses an LED load with  $57V_{DC}$  @ 700mA unless otherwise noted. Case temperature range:  $-30^{\circ}C$  to  $90^{\circ}C$ ; production tested at  $25^{\circ}C$ .

Parameter	Symbol	Test Conditions / Comment	Min	Typ	Max	Units
Input Voltage	$V_{IN}$	Line Frequency 57 to 63 Hz	312		528	$V_{AC}$
Off Power	$P_{IN(MIN)}$	BRITE A $\leq 0.5V$ , $V_{IN} = 480V_{AC}$			0.5	W
Input AC Current	$I_{347}$	Measured at Full Load and $347V_{AC}$ Input			175	mA
	$I_{480}$	Measured at Full Load and $480V_{AC}$ Input			125	mA
Maximum Inrush Current	$I_{INRUSH}$	Measure at $480V_{AC}$ Peak AC Line; Maximum Duration 10 $\mu$ s			60	A
		Measure at $480V_{AC}$ Peak AC Line Measured after 10 $\mu$ s			5	A
Power Factor		Full Load, $347V_{AC}$ to $480V_{AC}$	0.9			PF
Efficiency	$\eta$	Full Load, $V_{LED} = 57V$ , $V_{IN} = 480V_{AC}$	88	91		%
Total Harmonic Distortion	THD	Full load, $347V_{AC}$ to $480V_{AC}$			15	%

#### OUTPUTS

Average Sink Current	$I_{OUT-}$	$T_A = 25^{\circ}C$	665	700	735	mA
LED String Voltage	$V_{OUT\Delta}$	Rated LED current	20		57	V
Ripple (pk-pk)	$V_{OUT\Delta}$	Full Load, $V_{LED} = 57V$ , (pk to pk)/Average			2	%
Line Regulation	$I_{OUT-}$	$V_{IN} = \text{Nominal} \pm 10\%$ (i.e. $480V_{AC} \pm 10\%$ )			1	%
Load Regulation	$I_{OUT-}$	OUTPUT(+) 40V to 57V			1	%
Turn-on Time	$t_{TURN\_ON}$	Cold Start, Power ON		0.2	0.5	Sec
Output Overshoot / Undershoot	$I_{OUT+}$	Turning Power On or Off			10	%

#### Dimming

BRITE A Voltage Setting	$V_{BRITE\ A}$	For maximum brightness	9.5	10	10.5	V
		For Minimum brightness	0.95	1	1.05	
BRITE A Output Current	$I_{BRITE\ A}$	BRITE A to RETURN	1.19	1.25	1.37	mA
Minimum Output Current	$I_{MIN}$	BRITE A = 0.95V		10		% of Max
Output Current Dim Range (Analog Dimming)		$I_{LED} = 700mA$ , BRITE A = 0.95V Versus BRITE A $\geq 10V$		10:1		RATIO
Shutdown Voltage	$V_{BRITE\ A}$				0.8	V

#### FAULT

Output Voltage Low	$V_{FAULT}$	Short OUTPUT(+) to OUT(-), FAULT = 8mA			0.8	V
Leakage Current	$I_{FAULT}$	No fault, $V_{FAULT} = 57V$			10	$\mu$ A

#### Protection

Overvoltage Protection	$V_{OV}$	Maximum OUT(+)	57.5	58.5	59.5	V
Over Temperature Shutdown	$T_{OT}$	Over Case Temperature Protection Hot Spot	90	95		$^{\circ}C$



### Safety & EMC Compliance

UL	Compliance to UL8750 & UL1310 Class 2 File E337545
FCC Title 47, Part 15	Conducted and Radiated Emission, Class B
EN 61000-3-3	Voltage fluctuations and flicker
EN61000-4-2	Electrostatic Discharge Immunity
EN61000-4-3	Radiated Susceptibility test
EN61000-4-4	Electrical Fast Transient
EN61000-4-5 and ANSI C61.42.2	Surge Immunity Test, AC Power Line, Category C Low Exposure (6kV/3kV)
EN61000-4-6	Conducted Susceptibility Immunity test
EN61000-4-8	Power Frequency Magnetic Field Immunity Test
EN61000-4-11	Voltage Dips and Interruption Immunity
Life Expectancy	5 years / 50,000 hours @ 100% duty at maximum case temperature 55°C
MTBF	221,569 hours, case temperature 55°; 121,565 hours case temperature 70°C Bellcore TR-NWT-332, Issue 6; Method 1, Case 3, Ground Benign
Environmental Standards	EU RoHS, REACH

### LEAD DESCRIPTION

Name	Pin #	Description
<b>INPUT TERMINAL LEADS (18AWG)</b>		
BLACK	AC LINE	Main Input Power Supply Line 347V <sub>AC</sub> to 480V <sub>AC</sub>
WHITE	AC NEUTRAL	Main Input Power Supply Neutral
<b>CONTROL TERMINAL LEADS (22AWG)</b>		
PURPLE	BRITE A	Analog Dimming Input (Full Brightness if Open)
GRAY	RETURN	RETURN
BROWN	FAULT	Fault Signal (Low During Whole LED String Short or Open)
<b>OUTPUT TERMINAL LEADS (18AWG)</b>		
RED	OUTPUT(+)	LED String Anode Voltage (High Side)
BLUE	OUTPUT(-)	OUTPUT (-) LED Cathode Voltage (Low Side) 700mA

### FAULT TABLE

CONDITION	OUTPUT(-)	FAULT	DRIVER STATUS	COMMENT
OUTPUT(+) String OUTPUT (-) (700mA)	ON	Hi-Z	ON	
OUTPUT(+) OPEN OUT(-)	OPEN	LOW	OUTPUT(+) Max Voltage	
OUTPUT(+) Short OUT(-)	OPEN	LOW	SHUTDOWN	
OUTPUT(+) String OUTPUT (-) w/ 1 or more LED short	ON	Hi-Z	ON	<b>STAYLIT™</b> , OUTPUT(+) ≥ 20V
Over Temperature at the Case Hot Spot	OPEN	LOW	SHUTDOWN	When the temperature goes down, the module turns on again (no user intervention)
Power Loss (Blackout) Event	OPEN	LOW	SHUTDOWN	When Power comes back, the module turns on again (no user intervention)
BRITE A Shorted TO RETURN or OUTPUT(-)	OPEN	Hi-Z	SHUTDOWN	
BRITE A OPEN (or Resistor > 12kOhm)	ON	Hi-Z	ON	



#### CONDITIONS OF ACCEPTABILITY

The components have been judged on the basis of the required spacings in the Standard for Class 2 Power Units, UL 1310.

The input and output leads are 18 AWG, rated 600V, 105°C, VW-1. The suitability of the leads shall be determined in each end-use application. The leads are suitable for factory wiring only, and additional investigation will be required for field wiring.

The polymeric housing is rated V-0 and has been subjected to a ball-impact test. The need for a suitable enclosure shall be considered in the end product.

The component has been evaluated for dry and damp locations, where the humidity conditioning and dielectric tests were conducted per UL 8750.

The maximum temperature measured on housing outside surface was 61.3°C during the Temperature Test when shifted to Ambient Temperature 40°C. The necessity of repeated Temperature Test shall be determined in each end use application.

A proper mechanical, electrical and fire enclosure shall be provided in the end-use application that is in compliance with all the applicable requirements of the end-use application.

Testing was on a 20 A branch circuit. If used on a branch circuit greater than this, additional testing may be necessary.

The LED driver is rated as noted in the Electrical Ratings Table above, and the outputs comply with the requirements for Class 2. The need for additional evaluation shall be considered in the end product if used beyond these ratings.

The LED driver is provided with dimmer leads for connecting an external 0-10 V<sub>DC</sub> source for dimming the output current. The leads colors are shown in box below. The dimmer circuit is considered as Class 2 circuit.

Lead Function	Color
AC LINE	BLACK
AC NEUTRAL	WHITE
OUTPUT(+)	RED
OUTPUT(-)	BLUE
RETURN	GRAY
FAULT	BROWN
BRITE A	PURPLE



#### TYPICAL CHARACTERISTIC CHARTS 25°C

#### BRITE A INPUT vs OUTPUT CURRENT and OUTPUT VOLTAGE @ VIN = 480V<sub>AC</sub>

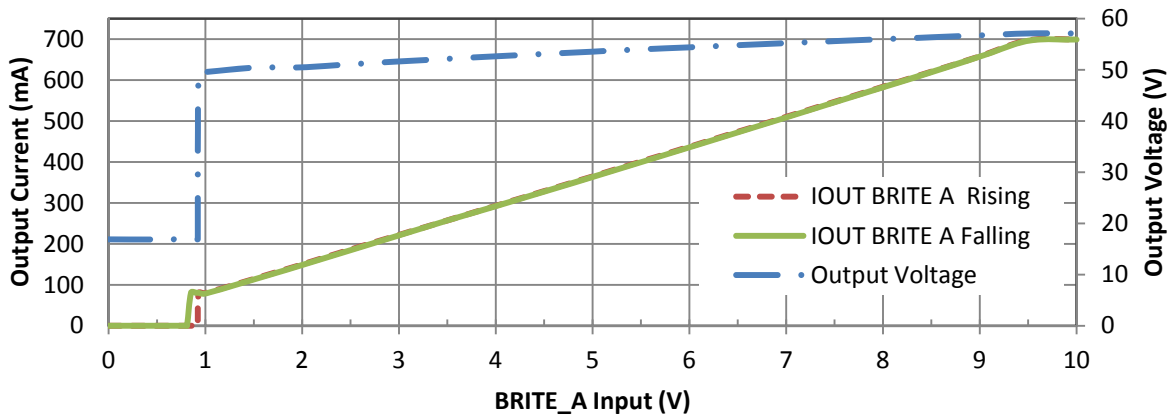

#### Power Factor vs Output Power

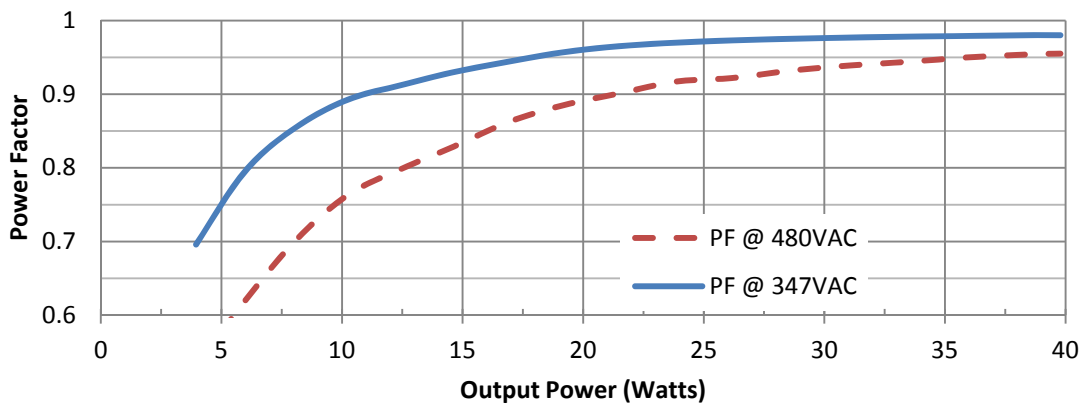

#### Efficiency vs Output Power

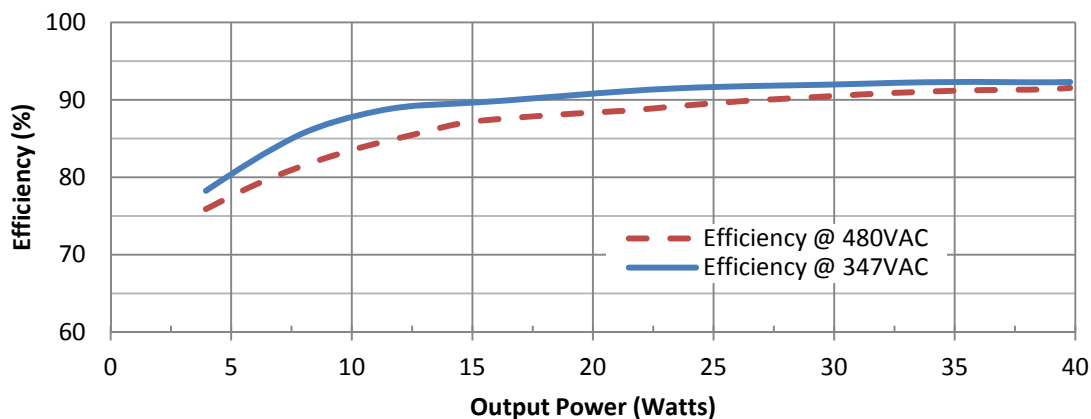



#### MECHANICAL DRAWING

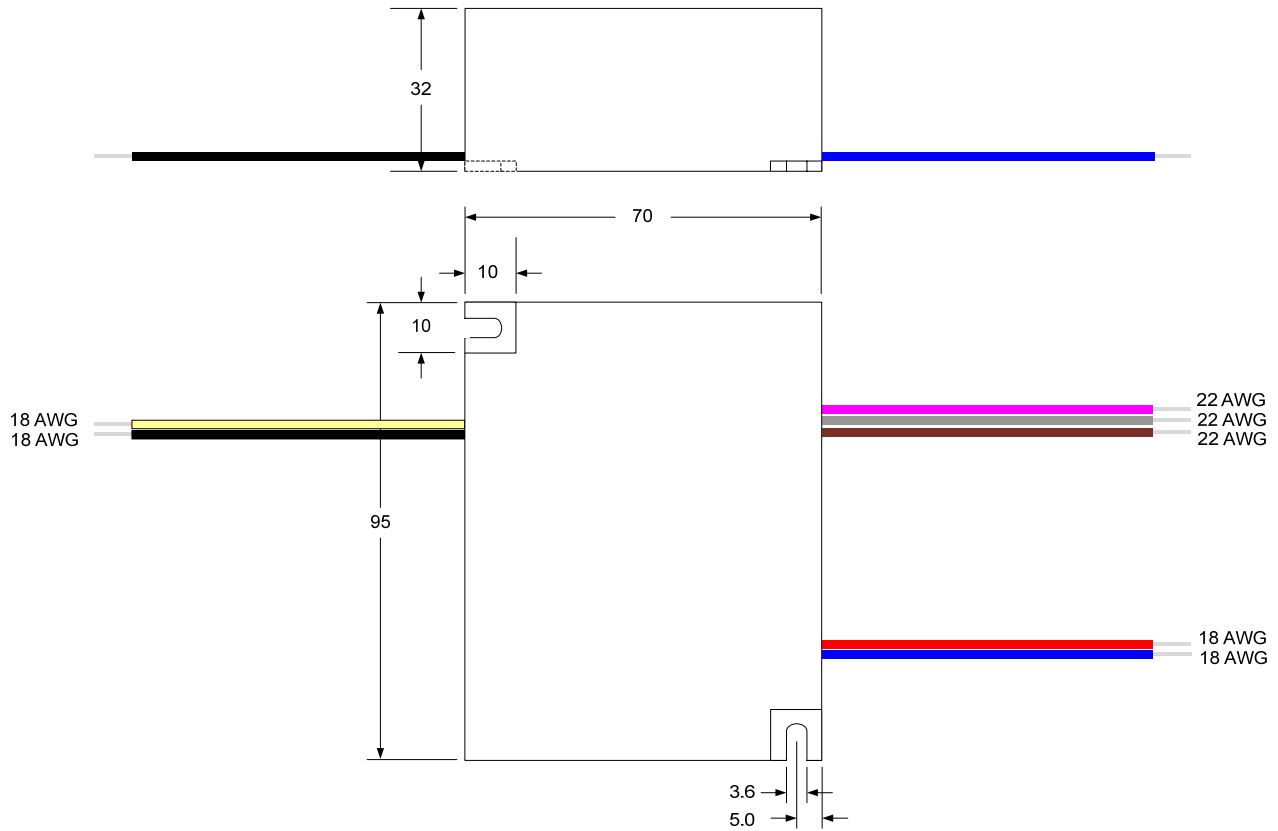

Wire length is 230mm ± 10mm, stripped 12mm ± 5mm UL1015 AWG#18 16/30 stranded 105°C Input & Output wires; AWG#22 7/30 stranded Control wires, all wires tinned. Please insure the wire nuts are installed correctly to prevent intermittent operation. Connecting the AC input to Control or Output wires will result in damage to the module.

#### APPLICATION INFORMATION

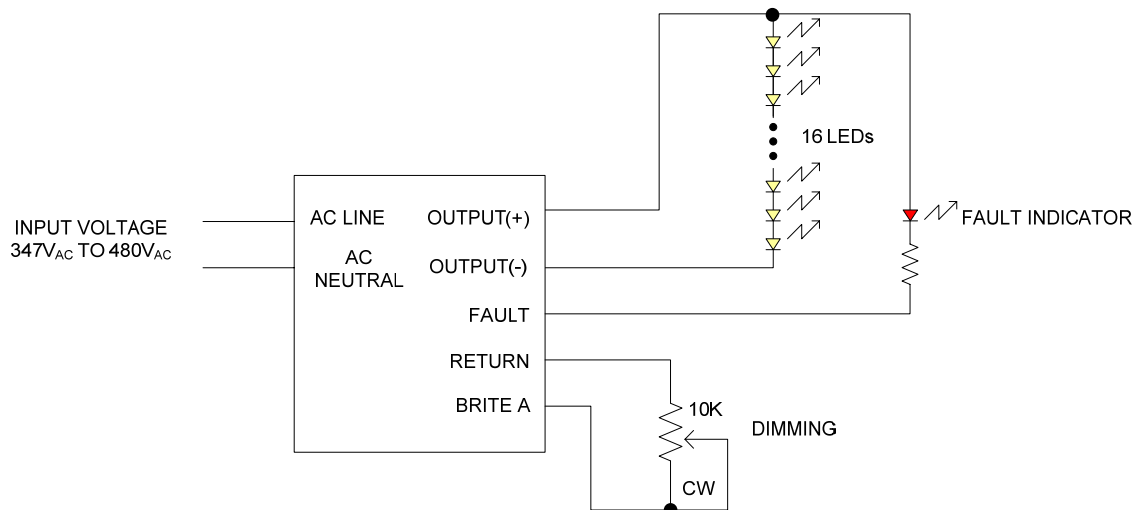



**Microsemi**<sup>®</sup>

**LXMG221D-0700040-D2F**

**40W 700mA Dimmable HV LED Driver Module**

**PRODUCTION DATASHEET**

NOTES

PRODUCTION DATA – Information contained in this document is proprietary to Microsemi and is current as of publication date. This document may not be modified in any way without the express written consent of Microsemi. Product processing does not necessarily include testing of all parameters. Microsemi reserves the right to change the configuration and performance of the product and to discontinue product at any time.