

MITSUBISHI IGBT MODULES  
**CM200DU-12H**  
 HIGH POWER SWITCHING USE  
 INSULATED TYPE

**CM200DU-12H**



- IC ..... 200A
- VCES ..... 600V
- Insulated Type
- 2-elements in a pack

**APPLICATION**

UPS, NC machine, AC-Drive control, Servo, Welders

**OUTLINE DRAWING & CIRCUIT DIAGRAM**

Dimensions in mm

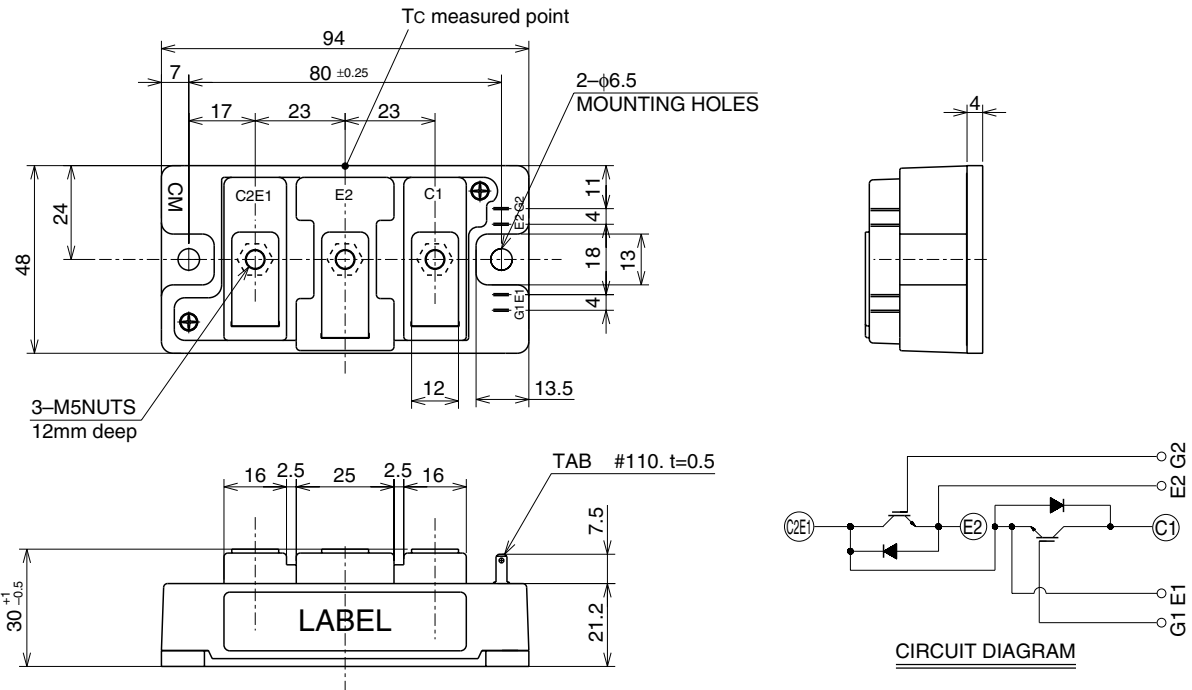

**CM200DU-12H**

**HIGH POWER SWITCHING USE  
INSULATED TYPE**

**MAXIMUM RATINGS (T<sub>j</sub> = 25°C, unless otherwise specified)**

Symbol	Item	Conditions	Ratings	Unit
V <sub>CE</sub> S	Collector-emitter voltage	V <sub>GE</sub> = 0V	600	V
V <sub>GE</sub> S	Gate-emitter voltage	V <sub>CE</sub> = 0V	±20	V
I <sub>C</sub>	Collector current	T <sub>C</sub> = 25°C	200	A
I <sub>CM</sub>		Pulse (Note 1)	400	A
I <sub>E</sub> (Note 2)	Emitter current	T <sub>C</sub> = 25°C	200	A
I <sub>EM</sub> (Note 2)		Pulse (Note 1)	400	A
P <sub>C</sub> (Note 3)	Maximum collector dissipation	T <sub>C</sub> = 25°C	650	W
T <sub>j</sub>	Junction temperature	—	-40 ~ +150	°C
T <sub>stg</sub>	Storage temperature	—	-40 ~ +125	°C
V <sub>iso</sub>	Isolation voltage	Charged part to base plate, f = 60Hz, AC 1 minute	2500	V <sub>rms</sub>
—	Mounting torque	Main terminals M5 screw	2.5 ~ 3.5	N·m
		Mounting M6 screw	3.5 ~ 4.5	N·m
—	Weight	Typical value	310	g

**ELECTRICAL CHARACTERISTICS (T<sub>j</sub> = 25°C, unless otherwise specified)**

Symbol	Item	Test Conditions	Limits			Unit	
			Min	Typ	Max		
I <sub>CES</sub>	Collector cutoff current	V <sub>CE</sub> = V <sub>CE</sub> S, V <sub>GE</sub> = 0V	—	—	1	mA	
V <sub>GE(th)</sub>	Gate-emitter threshold voltage	I <sub>C</sub> = 20mA, V <sub>CE</sub> = 10V	4.5	6	7.5	V	
I <sub>GES</sub>	Gate-leakage current	±V <sub>GE</sub> = V <sub>GES</sub> , V <sub>CE</sub> = 0V	—	—	0.5	μA	
V <sub>CE(sat)</sub>	Collector-emitter saturation voltage	I <sub>C</sub> = 200A, V <sub>GE</sub> = 15V (Note 4)	T <sub>j</sub> = 25°C	—	2.4	3.0	V
			T <sub>j</sub> = 125°C	—	2.6	—	
C <sub>ies</sub>	Input capacitance	V <sub>CE</sub> = 10V	—	—	17.6	nF	
C <sub>oes</sub>	Output capacitance	V <sub>GE</sub> = 0V	—	—	9.6	nF	
C <sub>res</sub>	Reverse transfer capacitance	—	—	—	2.6	nF	
Q <sub>G</sub>	Total gate charge	V <sub>CC</sub> = 300V, I <sub>C</sub> = 200A, V <sub>GE</sub> = 15V	—	400	—	nC	
t <sub>d(on)</sub>	Turn-on delay time	V <sub>CC</sub> = 300V, I <sub>C</sub> = 200A	—	—	150	ns	
t <sub>r</sub>	Turn-on rise time	V <sub>GE</sub> = ±15V	—	—	400	ns	
t <sub>d(off)</sub>	Turn-off delay time	R <sub>G</sub> = 3.1Ω	—	—	300	ns	
t <sub>f</sub>	Turn-off fall time	Resistive load	—	—	300	ns	
V <sub>EC</sub> (Note 2)	Emitter-collector voltage	I <sub>E</sub> = 200A, V <sub>GE</sub> = 0V	—	—	2.6	V	
t <sub>rr</sub> (Note 2)	Reverse recovery time	I <sub>E</sub> = 200A,	—	—	160	ns	
Q <sub>rr</sub> (Note 2)	Reverse recovery charge	die / dt = -400A / μs	—	0.48	—	μC	
R <sub>th(j-c)Q</sub>	Thermal resistance (Note 5)	Junction to case, IGBT part (Per 1/2 module)	—	—	0.19	K/W	
R <sub>th(j-c)R</sub>		Junction to case, FWDi part (Per 1/2 module)	—	—	0.35	K/W	
R <sub>th(c-f)</sub>	Contact thermal resistance	Case to heat sink, conductive grease applied (Per 1/2 module) (Note 6)	—	0.07	—	K/W	

- Note 1. Pulse width and repetition rate should be such that the device junction temperature (T<sub>j</sub>) does not exceed T<sub>jmax</sub> rating.  
 2. I<sub>E</sub>, V<sub>EC</sub>, t<sub>rr</sub>, Q<sub>rr</sub> & die/dt represent characteristics of the anti-parallel, emitter-collector free-wheel diode.  
 3. Junction temperature (T<sub>j</sub>) should not increase beyond 150°C.  
 4. Pulse width and repetition rate should be such as to cause negligible temperature rise.  
 5. Case temperature (T<sub>C</sub>) measured point is shown in page OUTLINE DRAWING.  
 6. Typical value is measured by using thermally conductive grease of λ = 0.9[W/(m · K)].

# CM200DU-12H

HIGH POWER SWITCHING USE  
INSULATED TYPE

## PERFORMANCE CURVES

**OUTPUT CHARACTERISTICS (TYPICAL)**

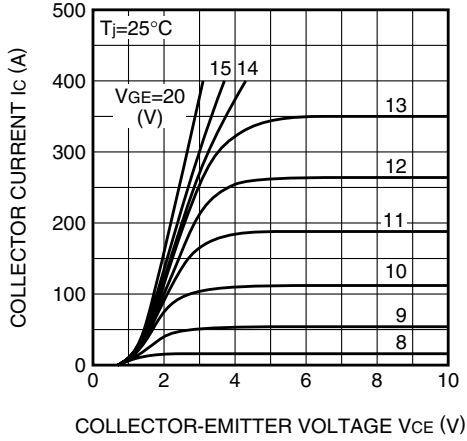

**TRANSFER CHARACTERISTICS (TYPICAL)**

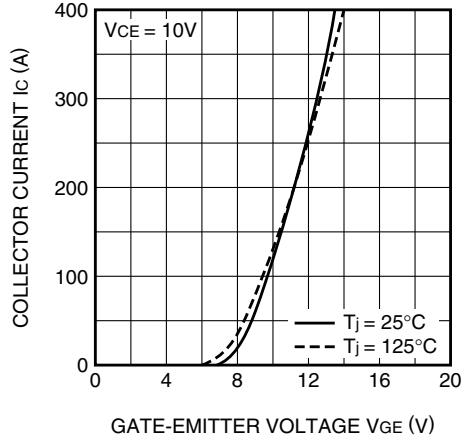

**COLLECTOR-EMITTER SATURATION VOLTAGE CHARACTERISTICS (TYPICAL)**

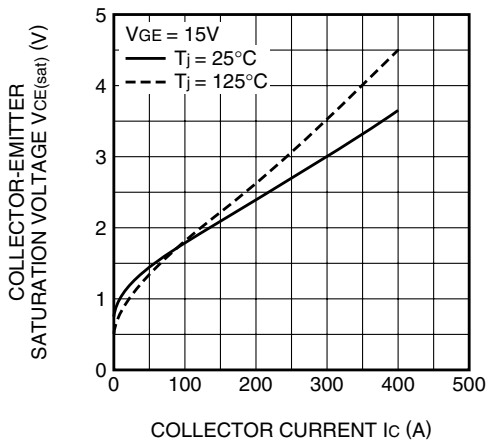

**COLLECTOR-EMITTER SATURATION VOLTAGE CHARACTERISTICS (TYPICAL)**

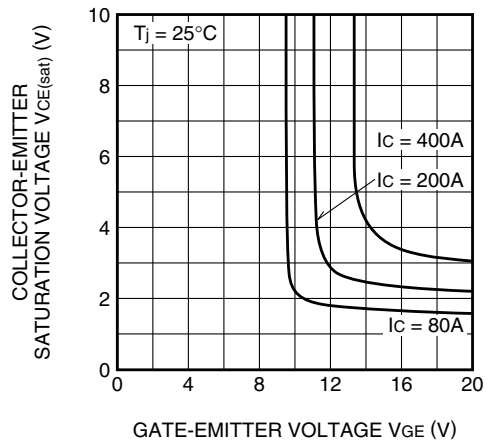

**FREE-WHEEL DIODE FORWARD CHARACTERISTICS (TYPICAL)**

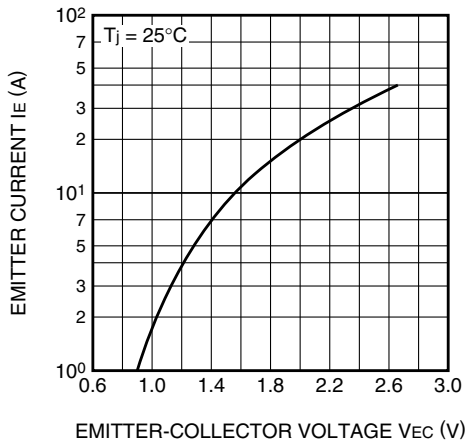

**CAPACITANCE CHARACTERISTICS (TYPICAL)**

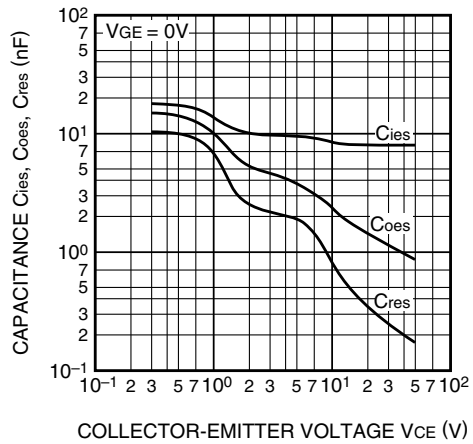

CM200DU-12H

HIGH POWER SWITCHING USE  
INSULATED TYPE

HALF-BRIDGE  
SWITCHING TIME CHARACTERISTICS  
(TYPICAL)

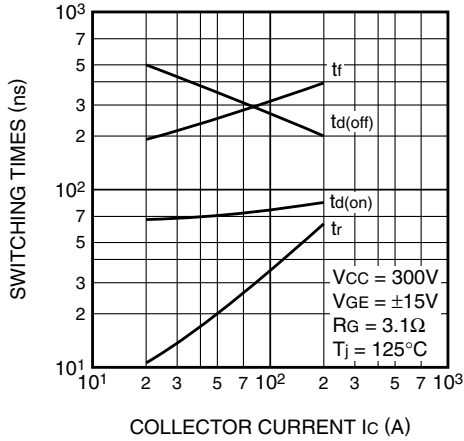

REVERSE RECOVERY CHARACTERISTICS  
OF FREE-WHEEL DIODE  
(TYPICAL)

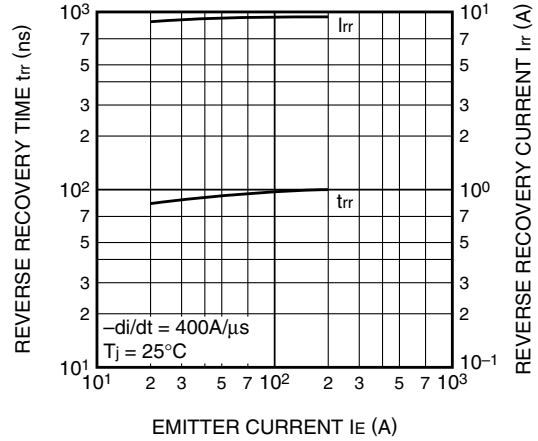

TRANSIENT THERMAL  
IMPEDANCE CHARACTERISTICS  
(IGBT part)

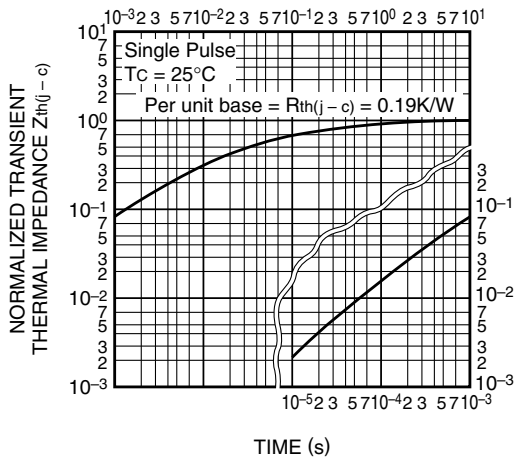

TRANSIENT THERMAL  
IMPEDANCE CHARACTERISTICS  
(FWDi part)

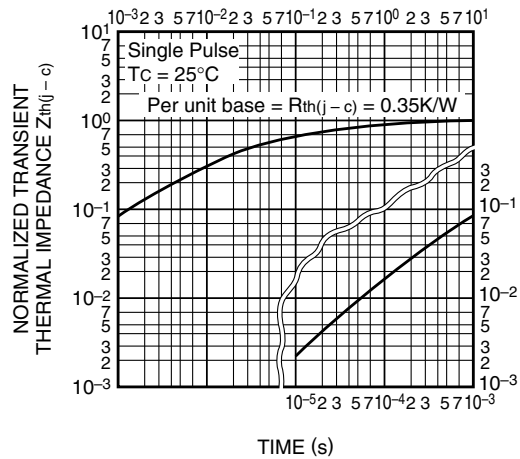

GATE CHARGE CHARACTERISTICS  
(TYPICAL)

