

LARISA-RZ-CLIP8

~25° diffused beam. Clip fastening for 0.8 mm thick PCB

TECHNICAL SPECIFICATIONS:

Dimensions	9.9x9.9 mm
Height	7.5 mm
Fastening	clips
Colour	black
Box size	
Box weight	6.6 kg
Quantity in Box	10000 pcs
ROHS compliant	yes ⓘ



MATERIAL SPECIFICATIONS:

Component	Type	Material	Colour
LARISA-RZ	Lens	PMMA	clear
LARISA-HOLDER-CLIP8	Holder	PC	black

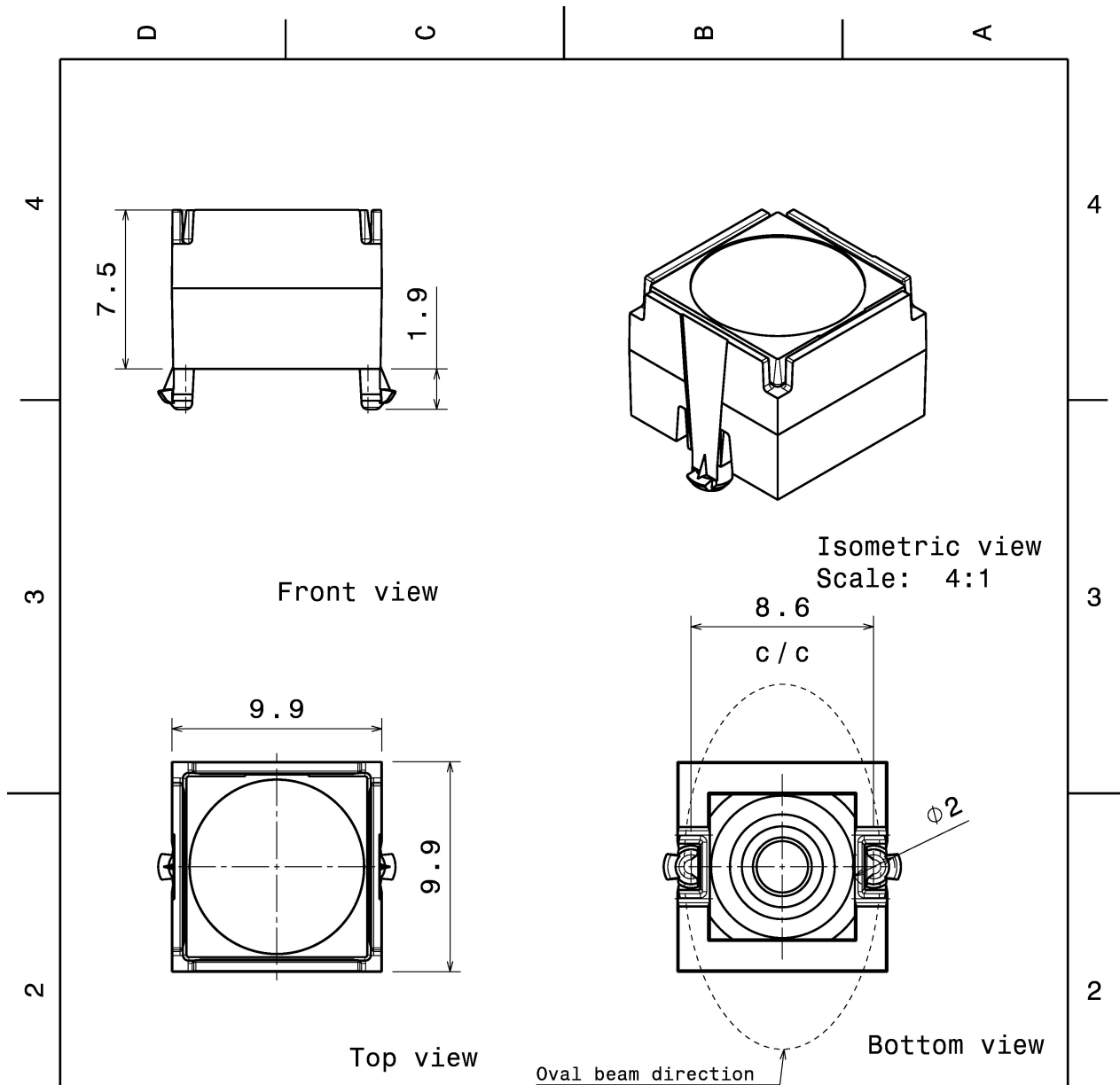

INDEX	PART NO	DESCRIPTION	MATERIAL	COLOUR
1	-	LARISA lens	PMMA	
2	C12907	LARISA-HOLDER-CLIP8	PC	black

Tolerances if not otherwise shown
According to DIN ISO 2768-1
Linear measures:
Up to 30mm class M, otherwise class C.
According to DIN ISO 2768-2
Form and position: class L



Ledil Oy
Salorankatu 10
FIN 24240 SALO
Finland

THIRD ANGLE PROJECTION:

DRAWING TITLE

LARISA-CLIP8

This drawing is the property of LEDiL Oy. It may not be reproduced, copied or communicated without a written agreement with LEDiL Oy.

SIZE PART NUMBER

A4

WEIGHT 0,6 g

SHEET 1/1

PHOTOMETRIC DATA (MEASURED):

CREE 

LED XB-D
FWHM 27.0°
Efficiency 73 %
Peak intensity 2.280 cd/lm
Required components:



CREE 

LED XQ-E
FWHM 24.0°
Efficiency 77 %
Peak intensity 2.600 cd/lm
Required components:

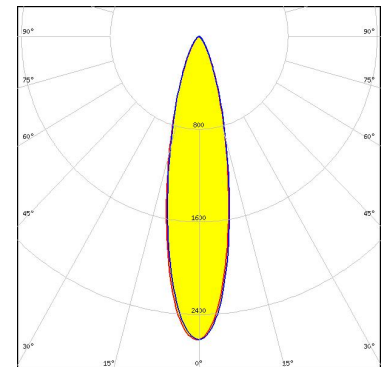
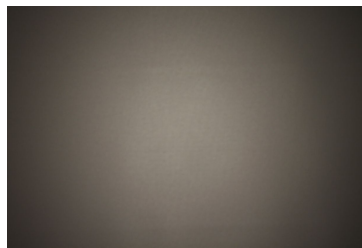

CREE 

LED XQ-E HI
FWHM 21.0°
Efficiency 71 %
Peak intensity 3.400 cd/lm
Required components:

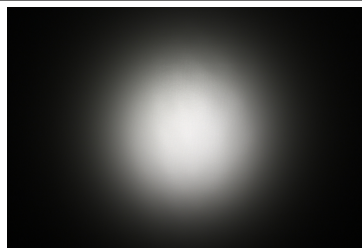

 **LUMILEDS**

LED LUXEON C
FWHM 26.0°
Efficiency 75 %
Peak intensity 2.400 cd/lm
Required components:

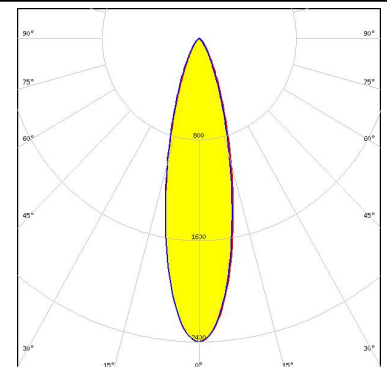
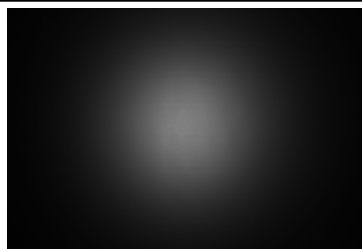

PHOTOMETRIC DATA (MEASURED):

LUMILEDS

LED LUXEON Z
FWHM 22.0°
Efficiency 75 %
Peak intensity 3.270 cd/lm
Required components:

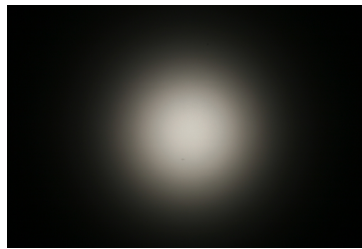

LUMILEDS

LED LUXEON Z ES
FWHM 26.0°
Efficiency 71 %
Peak intensity 1.930 cd/lm
Required components:

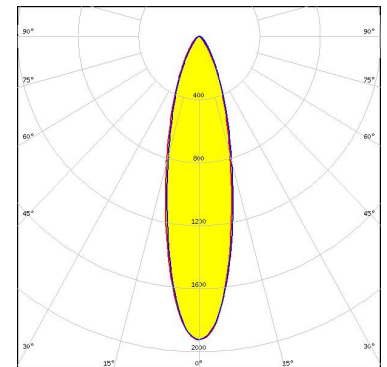
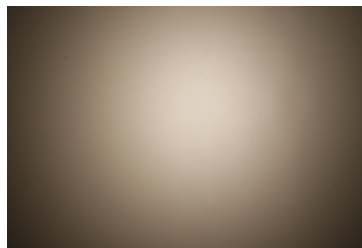

NICHIA

LED NF2x757G
FWHM 31.0°
Efficiency 74 %
Peak intensity 1.430 cd/lm
Required components:

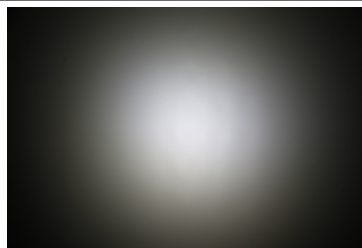

OSRAM

Opto Semiconductors

LED Duris S5 (2 chip)
FWHM 32.0°
Efficiency 72 %
Peak intensity 1.600 cd/lm
Required components:

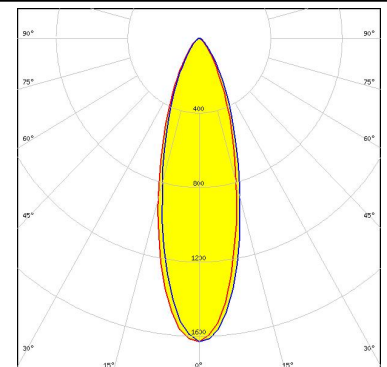

GENERAL INFORMATION:

NOTE: The typical beam angle will be changed by different color, chip size and chip position tolerance. The typical total beam angle is the full angle measured where the luminous intensity is half of the peak value.

MATERIALS:

As part of our continuous research and improvement processes, and to ensure the best possible quality and availability of our products, LEDiL reserves the right to change material grades without notice.

PRODUCT DATA USER AGREEMENT AND DISCLAIMER:

The measured data in the provided downloadable LEDiL Product Datasheets and Mechanical 2D-Drawings is rounded and provided as reference for planning. LEDiL Oy's optical specifications have been verified by conducting performance testing of the products in accordance with the company's quality system. The reported data are averaged results of multiple measurements with typical variation. LEDiL Oy reserves the right to without prior notification make changes and improvements to its products.

LEDiL Oy assumes neither warranty, nor guarantee nor any other liability of any kind for the contents and correctness of the provided data. The provided data has been generated with highest diligence but the provided data may in reality not represent the complete possible variation range of all intrinsic parameters. Therefore, in certain cases a deviation from the provided data could occur.

LEDiL Oy reserves the right to undertake technical changes of its products without further notification which could lead to changes in the provided data. LEDiL Oy assumes no liability of any kind for the possible deviation from any provided data or any other damage resulting from the usage of the provided data.

The user agrees to this disclaimer and user agreement with the download or usage of the provided files.

LEDiL Oy

Joensuunkatu 13
FI-24240 SALO
Finland

LEDiL Inc.

228 West Page Street
Suite D
Sycamore IL 60178
USA

Local sales and technical support

[www.ledil.com/
where_to_buy](http://www.ledil.com/where_to_buy)

Shipping locations

Salo, Finland
Hong Kong, China

Distribution Partners

[www.ledil.com/
where_to_buy](http://www.ledil.com/where_to_buy)