

LOC	DIST	REVISIONS					
E	B	P	LTR	DESCRIPTION	DATE	DWN	APVD
			BA	NEW RELEASE	10-NOV-08	SM	St.P

FOR FURTHER INFORMATION SEE DATA SHEET FOR
CRG SERIES-THICK FILM CHIP RESISTORS

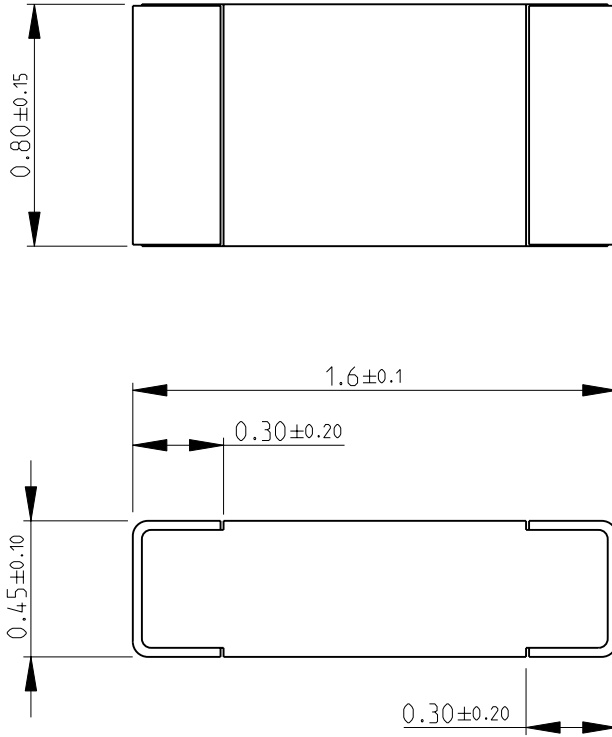

RoHS Compliant

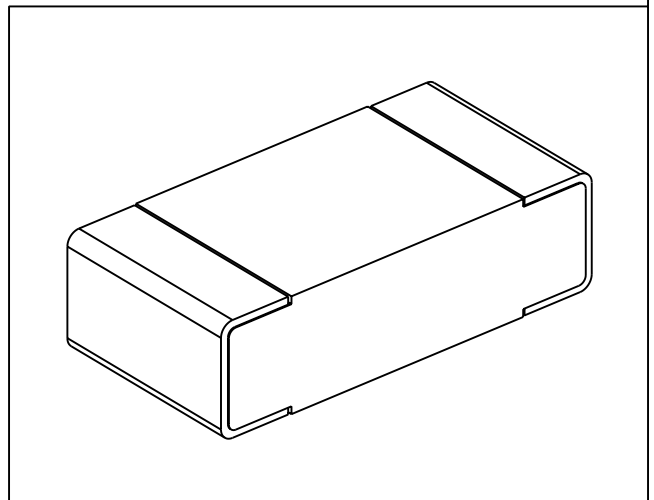

2008

RELEASED FOR PUBLICATION

THIS DRAWING IS UNPUBLISHED.

© COPYRIGHT 2008 BY TYCO ELECTRONICS CORPORATION. ALL RIGHTS RESERVED.

DIMENSIONS: mm	DWN	SUBHASH.M	10-NOV-08	MATERIAL	-	FINISH	-	
	CHK	PRAKASH.S	10-NOV-08	Tyco Electronics Corporation Dorcan, Swindon, SN3 5HH				
TOLERANCES UNLESS OTHERWISE SPECIFIED:	APVD	STEPHEN.P	10-NOV-08					NAME
	0 PLC ±0.5	PRODUCT SPEC	-	SIZE	CAGE CODE	DRAWING NO	RESTRICTED TO	
1 PLC ±0.2	APPLICATION SPEC	-	A 4	00779	© = 1623094	-		
2 PLC ±0.1	WEIGHT	-	CUSTOMER DRAWING				SCALE	40:1
3 PLC ±-							SHEET	1 OF 1
4 PLC ±-							REV	BA
ANGLES ±5°								