

---

## Sup/IRBuck™

### USER GUIDE FOR IRDC3891 EVALUATION BOARD

#### DESCRIPTION

The IR3891 is a dual synchronous buck converter, providing a compact, high performance and flexible solution in a small 5mm X 6mm Power QFN package.

Key features offered by the IR3891 include internal Digital Soft Start, precision 0.5V reference voltage, Power Good, thermal protection, programmable switching frequency, Enable input, input under-voltage lockout for proper start-up, enhanced line/load regulation with feed forward, external frequency synchronization with smooth clocking, internal LDO, pre-bias start-up,

output over voltage protection as well as open feedback line protection.

Output over-current protection function is implemented by sensing the voltage developed across the on-resistance of the synchronous rectifier MOSFET for optimum cost and performance and the current limit is thermally compensated.

This user guide contains the schematic and bill of materials for the IRDC3891 evaluation board. The guide describes operation and use of the evaluation board itself. Detailed application information for IR3891 is available in the IR3891 data sheet.

---

#### BOARD FEATURES

- $V_{in} = +12.0V$
- $F_s = 600kHz$
- $V_{out1} = +1.8V @ 4A$
- $L_1 = 2.2\mu H$
- $C_{out1} = 4 \times 22\mu F$  (ceramic 0805)
- $C_{in} = 4 \times 10\mu F$  (ceramic 1206) +  $1 \times 330\mu F$  (electrolytic)

$$V_{out2} = +1.2V @ 4A$$

$$L_2 = 1.5\mu H$$

$$C_{out2} = 4 \times 22\mu F$$
 (ceramic 0805)

## CONNECTIONS and OPERATING INSTRUCTIONS

A well regulated +12.0V input supply should be connected to VIN+ and VIN-. A maximum 4A load should be connected to VOUT+ and VOUT-. The connection diagram is shown in Fig. 1 and inputs and outputs of the board are listed in Table I.

IR3891 has only one input supply and internal LDO generates Vcc from Vin. If operation with external Vcc is required, then R3 should be removed and external Vcc should be applied between Vcc+ and Vcc- pins. Vin pin (input of the LDO) and Vcc/LDO pins should be shorted together (populate R4) for external Vcc operation.

The output of channel2 (Vout<sub>2</sub>) can follow the voltage at the Seq pin. For this purpose, The value of R5 and R6 can be selected to provide the desired sequencing ratio between Seq input and Vout<sub>2</sub>. For normal operation (non-sequencing) Seq pin should be left floating. Seq pin is internally pulled up to 3.3V.

**Table I. Connections**

Connection	Signal Name
VIN+	PV <sub>in</sub> (+12V)
VIN-	Ground of PV <sub>in</sub>
VOUT1+	V <sub>out1</sub> (+1.8V)
VOUT1-	Ground of Vout <sub>1</sub>
VOUT2+	V <sub>out2</sub> (+1.2V)
VOUT2-	Ground of Vout <sub>2</sub>
VCC+	VCC/LDO pin
VCC-	Connected to PGND
VSEQ	Sequence input
EN1, EN2	Enable input of each channel
Sync	Synchronous input

## LAYOUT

The PCB is a 4-layer board. All of layers are 2 Oz. copper. The IR3891 and other components are mounted on the top and bottom side of the board.

Power supply decoupling capacitors, the Bootstrap capacitor and feedback components are located close to IR3891. The feedback resistors are connected to the output voltage at the point of regulation and are located close to IR3891. To improve efficiency, the circuit board is designed to minimize the length of the on-board power ground current path.

Connection Diagram

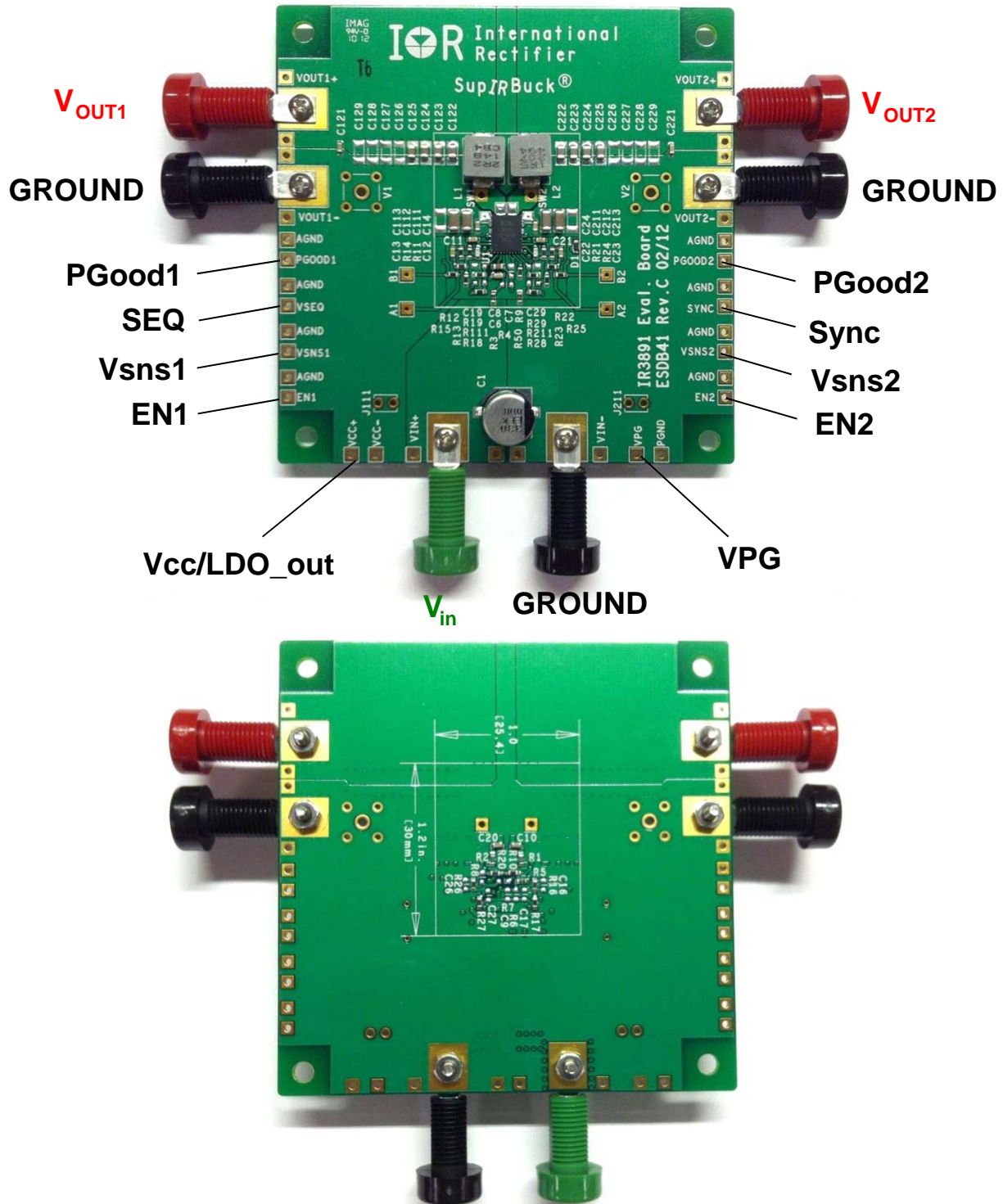

Fig. 1: Connection diagram of IRDC3891 evaluation board (top and bottom)

R50 is the  
Single point  
connection  
between AGND  
and PGND.

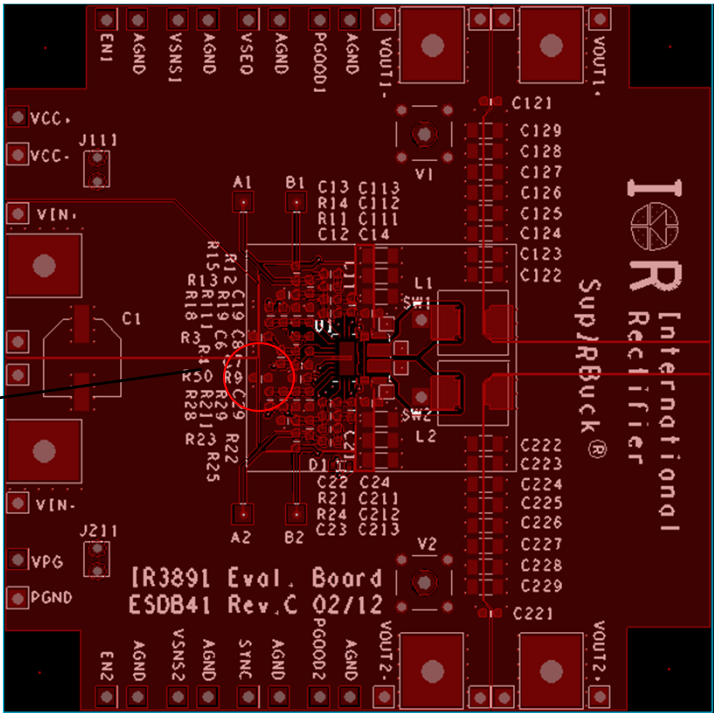

Fig. 2: Board layout, top layer

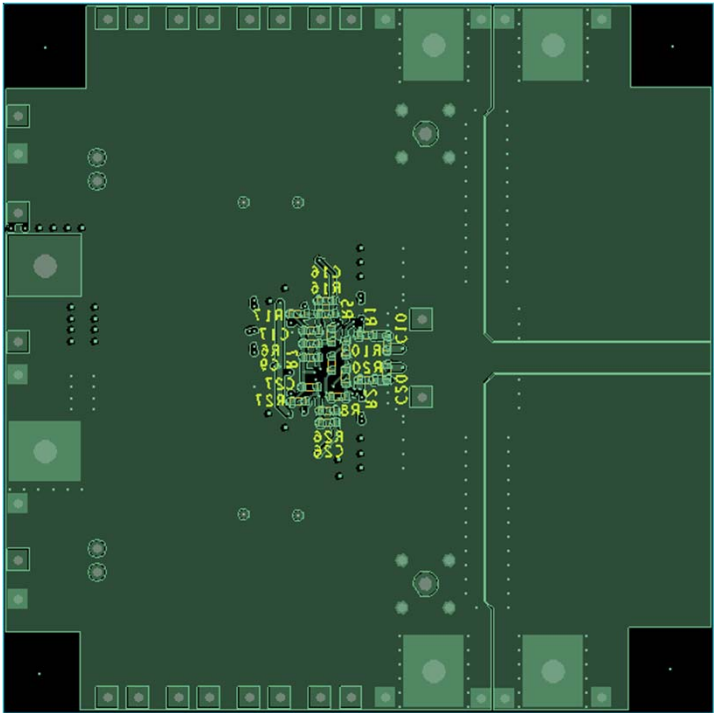
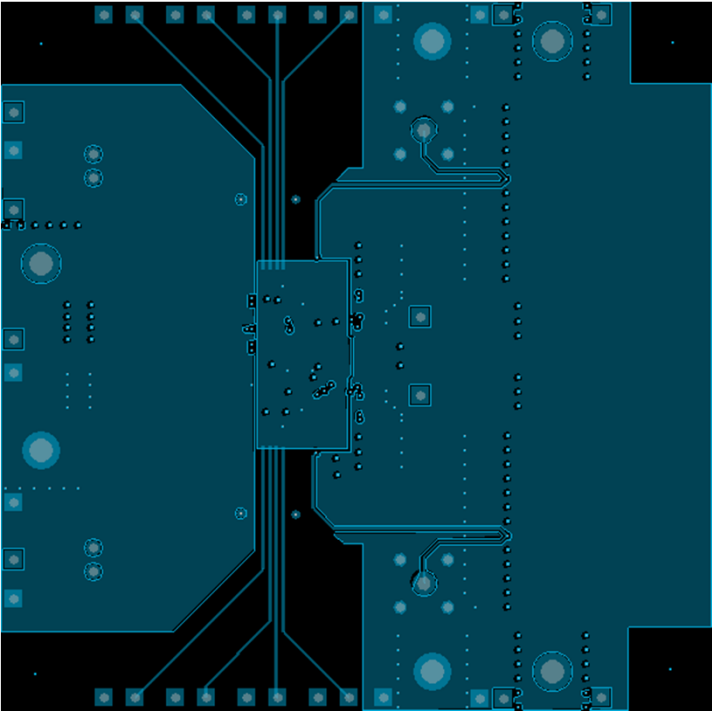
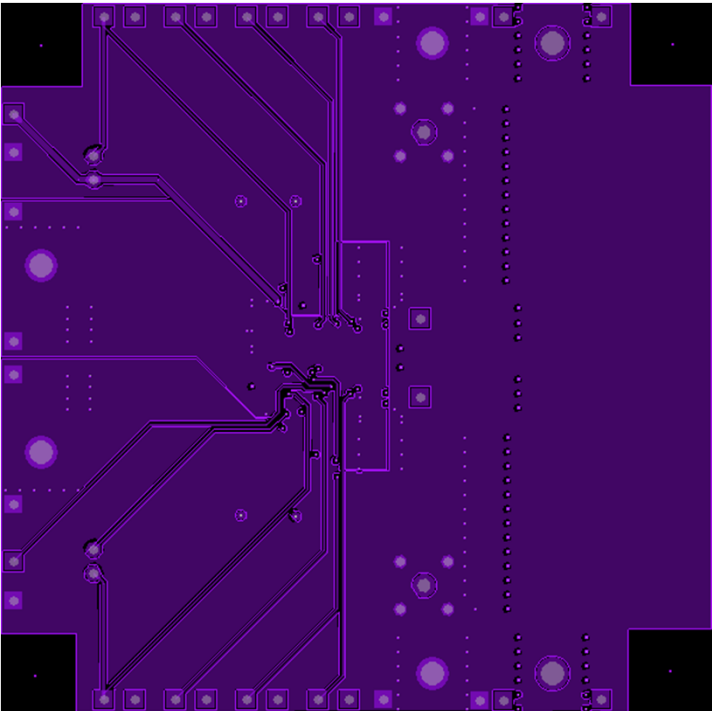

Fig. 3: Board layout, bottom layer



**Fig. 4: Board layout, mid-layer I**



**Fig. 5: Board layout, mid-layer II**

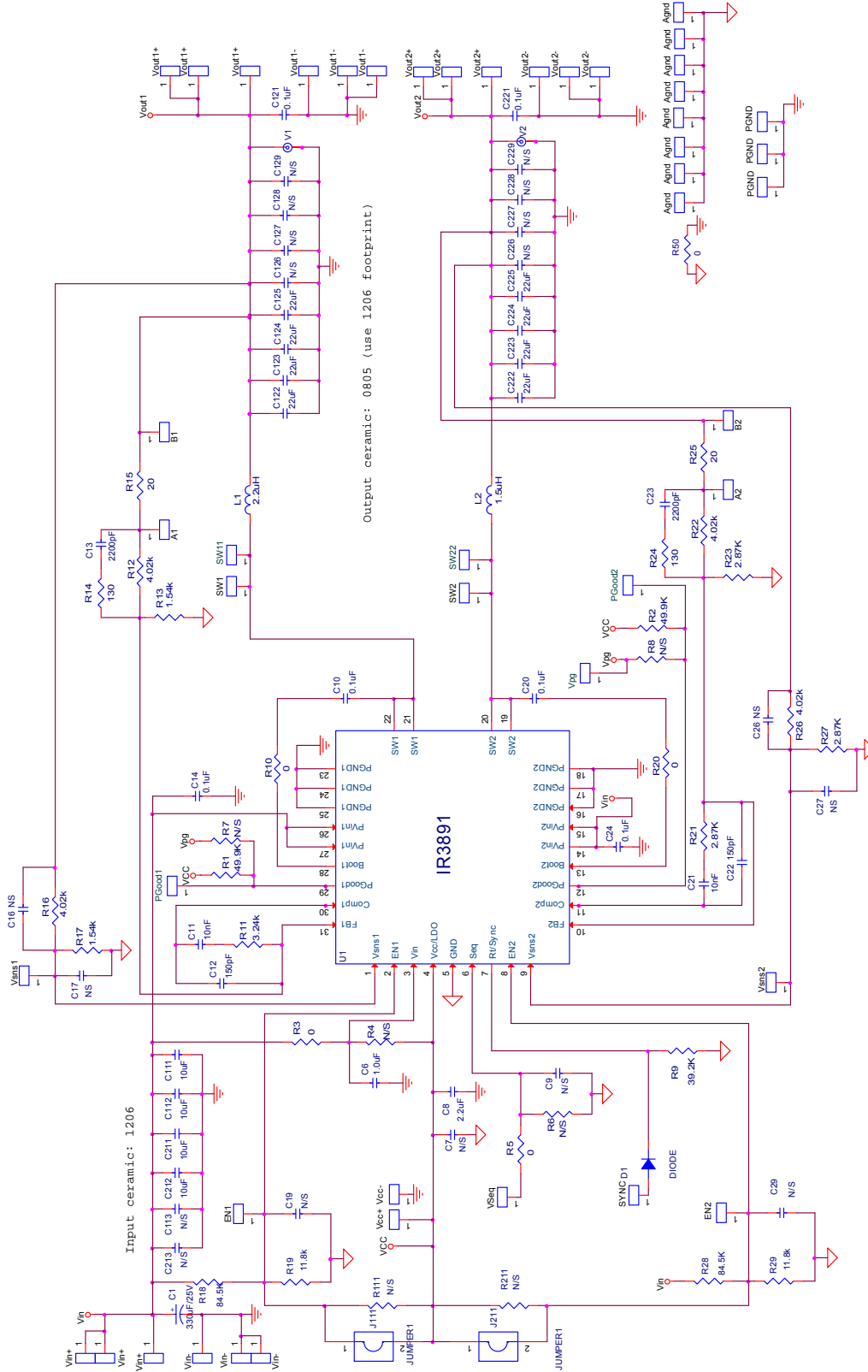

**Fig.6: Schematic of the IRDC3891 evaluation board**

**Bill of Materials**

Vin=12.0V, Vout1=1.8V/4A, Vout2=1.2V/4A, Fsw=600KHz						
Item	Qty	Part Reference	Value	Description	Manufacturer	Part Number
1	1	C1	330uF	SMD Electrolytic F size 25V 20%	Panasonic	EEV-FK1E331P
2	4	C111 C112 C211 C212	10uF	1206, 25V, X5R, 10%	TDK	C3216X5R1E106K
3	1	C6	1.0uF	0603, 25V, X5R, 10%	Murata	GRM188R61E105KA12D
4	1	C8	2.2uF	0603, 16V, X5R, 20%	TDK	C1608X5R1C225M
5	6	C10 C14 C20 C24 C121 C221	0.1uF	0603, 25V, X7R, 10%	Murata	GRM188R71E104KA01B
6	1	C11	10nF	0603, 50V, X7R, 10%	Murata	GRM188R71H103KA01B
7	1	C12	150pF	0603, 50V, NP0, 5%	Murata	GRM1885C1H151JA01D
8	2	C13 C23	2200pF	0603, 50V, X7R, 10%	Murata	GRM188R71H222KA01B
9	1	C21	10nF	0603, 50V, X7R, 10%	Murata	GRM188R71H103KA01B
10	1	C22	150pF	0603, 50V, NP0, 5%	Murata	GRM1885C1H151JA01D
11	8	C122 C123 C124 C125 C222 C223 C224 C225	22uF	0805, 6.3V, X5R, 20%	TDK	C2012X5R0J226M
12	1	L1	2.2uH	SMD 7.05x6.6x4.8mm, 11.2mΩ	Cyntec	PCMB065T-2R2MS
13	1	L2	1.5uH	SMD 7.05x6.6x4.8mm, 6.0mΩ	Cyntec	PCMB065T-1R5MS
14	2	R1 R2	49.9K	Thick Film, 0603, 1/10W, 1%	Panasonic	ERJ-3EKF4992V
15	5	R3 R5 R10 R20 R50	0	Thick Film, 0603, 1/10W	Panasonic	ERJ-3GEY0R00V
16	1	R9	39.2K	Thick Film, 0603, 1/10W, 1%	Panasonic	ERJ-3EKF3922V
17	1	R11	3.24K	Thick Film, 0603, 1/10W, 1%	Panasonic	ERJ-3EKF3241V
18	2	R12 R16	4.02K	Thick Film, 0603, 1/10W, 1%	Panasonic	ERJ-3EKF4021V
19	2	R13 R17	1.54K	Thick Film, 0603, 1/10W, 1%	Panasonic	ERJ-3EKF1541V
20	1	R14	130	Thick Film, 0603, 1/10W, 1%	Panasonic	ERJ-3EKF1300V
21	2	R15 R25	20	Thick Film, 0603, 1/10W, 1%	Panasonic	ERJ-3EKF20R0V
22	2	R18 R28	84.5K	Thick Film, 0603, 1/10W, 1%	Panasonic	ERJ-3EKF8452V
23	2	R19 R29	11.8K	Thick Film, 0603, 1/10W, 1%	Panasonic	ERJ-3EKF1182V
24	1	R21	2.87K	Thick Film, 0603, 1/10W, 1%	Panasonic	ERJ-3EKF2871V
25	2	R22 R26	4.02K	Thick Film, 0603, 1/10W, 1%	Panasonic	ERJ-3EKF4021V
26	2	R23 R27	2.87K	Thick Film, 0603, 1/10W, 1%	Panasonic	ERJ-3EKF2871V
27	1	R24	130	Thick Film, 0603, 1/10W, 1%	Panasonic	ERJ-3EKF1300V
28	2	J111 J211	jumper	This is a simple jumper		
29	1	D1		Schottky, 40V, SOD-523	Vishay	BAS40-02VGS08
30	1	U1	IR3891	PQFN 5x6mm	International Rectifier	IR3891MPBF

## TYPICAL OPERATING WAVEFORMS

$V_{in}=12.0V$ ,  $V_{cc}/LDO=5.3V$ ,  $V_{out1}=1.8V$ ,  $V_{out2}=1.2V$ ,  $I_{o1}=I_{o2}=0-4A$ , Room Temperature, No air flow

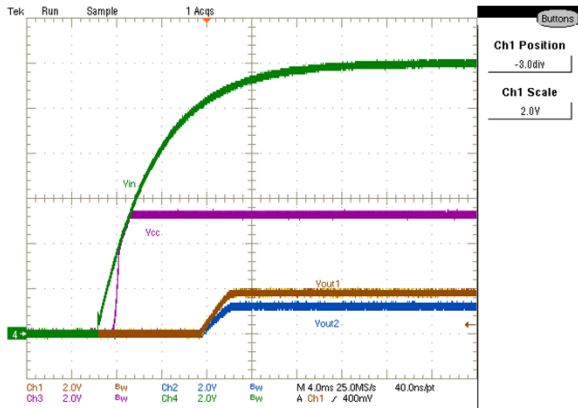

Fig. 7: Start up at 4A Load (Note 1)  
Ch<sub>1</sub>:Vout<sub>1</sub>, Ch<sub>2</sub>:Vout<sub>2</sub>, Ch<sub>3</sub>:Vcc/LDO, Ch<sub>4</sub>:Vin

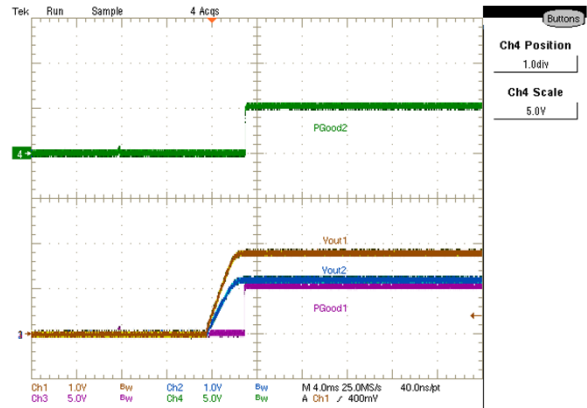

Fig. 8: Start up at 4A Load (Note 1)  
Ch<sub>1</sub>:Vout<sub>1</sub>, Ch<sub>2</sub>:Vout<sub>2</sub>, Ch<sub>3</sub>:PGood<sub>1</sub>, Ch<sub>4</sub>:PGood<sub>2</sub>

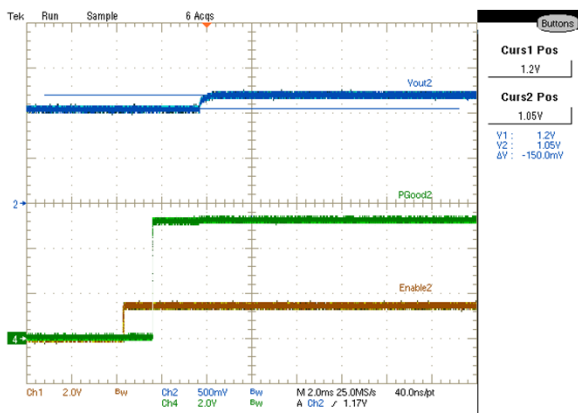

Fig. 9: Start up with 1.05V Prebias, 0A Load  
Ch<sub>1</sub>:Enable<sub>2</sub>, Ch<sub>2</sub>:Vout<sub>2</sub>, Ch<sub>4</sub>:PGood<sub>2</sub>

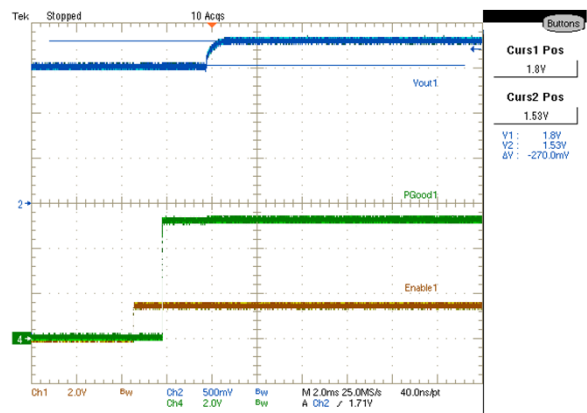

Fig. 10: Start up with 1.52V Prebias, 0A Load  
Ch<sub>1</sub>:Enable<sub>1</sub>, Ch<sub>2</sub>:Vout<sub>1</sub>, Ch<sub>4</sub>:PGood<sub>1</sub>

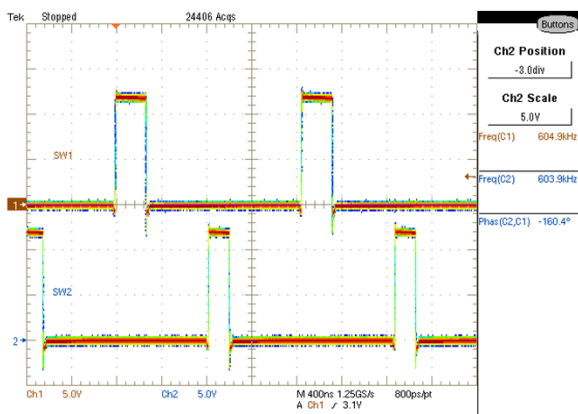

Fig. 11: Inductor switch node at 4A load / Channel  
Ch<sub>1</sub>:SW<sub>1</sub>, Ch<sub>2</sub>:SW<sub>2</sub>

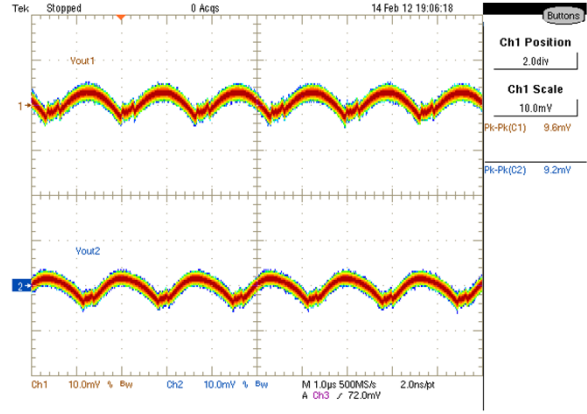

Fig. 12: Output Voltage Ripple, 4A load/channel (Note2)  
Ch<sub>1</sub>: Vout<sub>1</sub>, Ch<sub>2</sub>: Vout<sub>2</sub>



**TYPICAL OPERATING WAVEFORMS**

$V_{in}=12.0V$ ,  $V_{cc}/LDO=5.3V$ ,  $V_{out1}=1.8V$ ,  $V_{out2}=1.2V$ , Room Temperature, No air flow

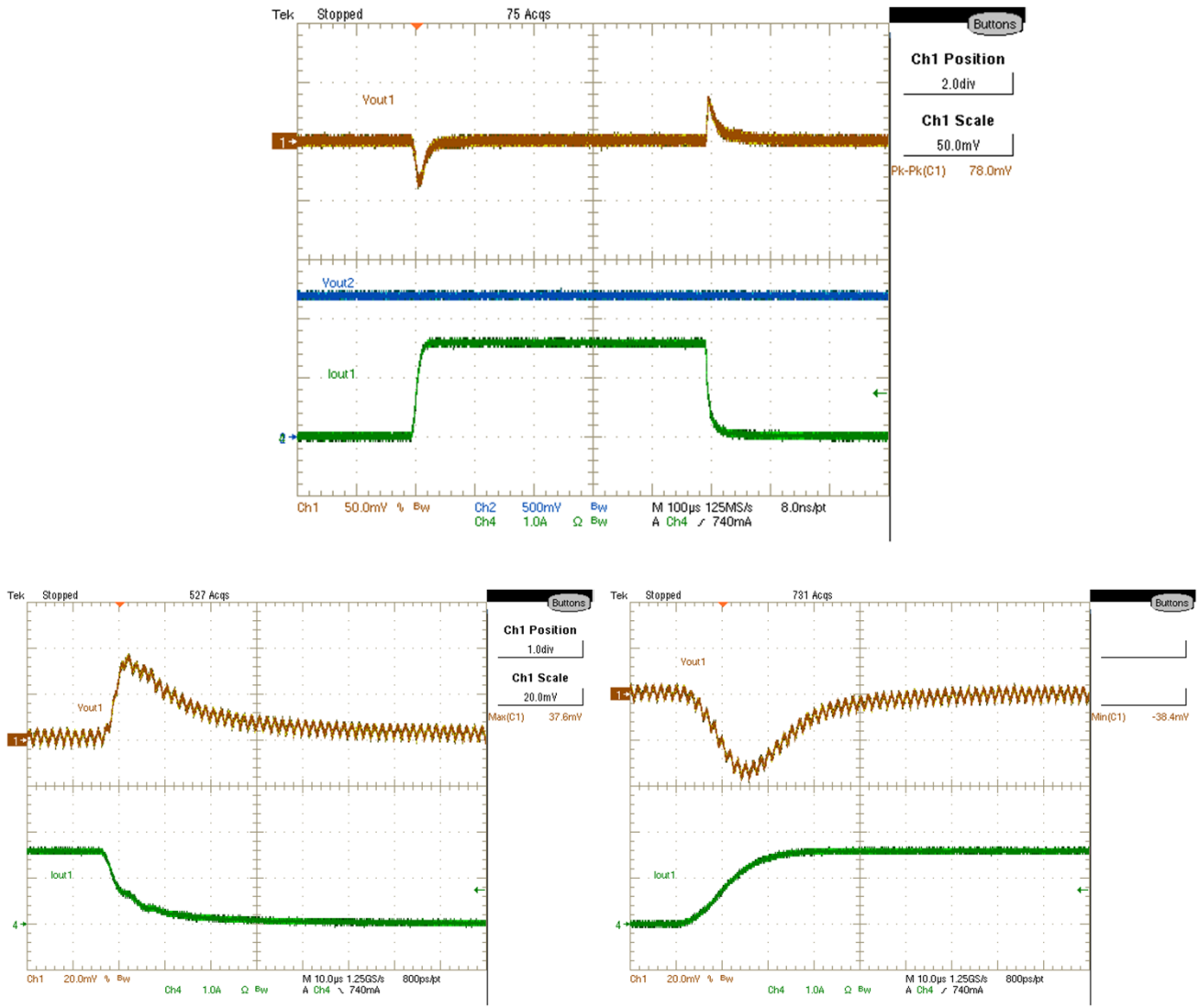

Fig. 15: Transient Response of channel1  
 0A-1.6A (0-40%), Ch<sub>1</sub>:Vout<sub>1</sub>, Ch<sub>2</sub>:Vout<sub>2</sub>, Ch<sub>4</sub>: Iout<sub>1</sub>

## TYPICAL OPERATING WAVEFORMS

$V_{in}=12.0V$ ,  $V_{cc}/LDO=5.3V$ ,  $V_{out1}=1.8V$ ,  $V_{out2}=1.2V$ , Room Temperature, No air flow

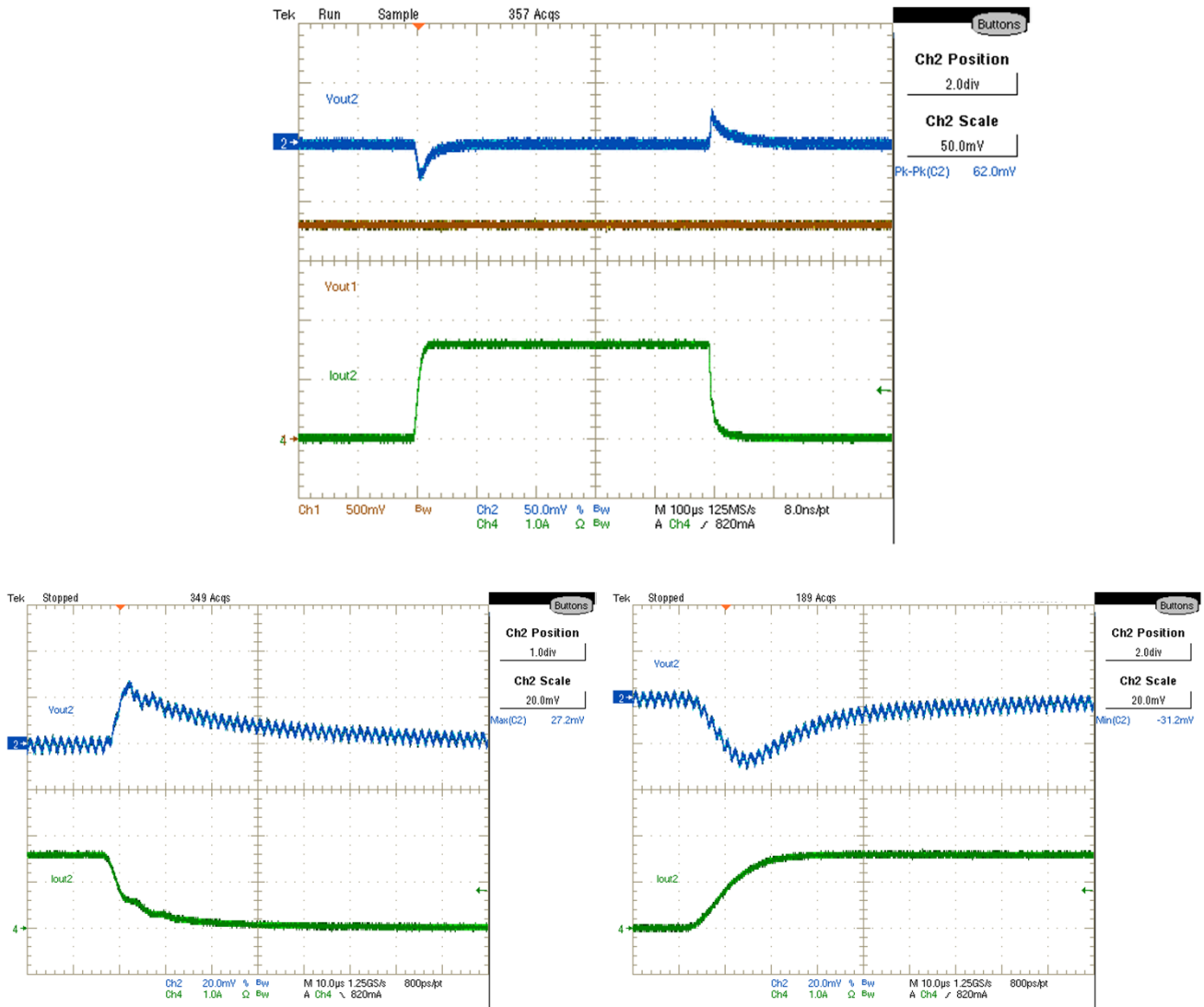

Fig. 16: Transient Response of channel2  
0A-1.6A (0-40%), Ch<sub>1</sub>:Vout<sub>1</sub>, Ch<sub>2</sub>:Vout<sub>2</sub>, Ch<sub>4</sub>: Iout<sub>2</sub>

Note1: Enable is tied to Vin via a resistor divider.

Note2: Vo ripple signal is taken across C125 and C225 capacitors.

**Bode Plot, Channel1**

Vin=12.0V, Vcc/LDO=5.3V, Vout<sub>1</sub>=1.8V, Vout<sub>2</sub>=1.2V, Io<sub>1</sub>= Io<sub>2</sub>=4A, Room Temperature, No air flow

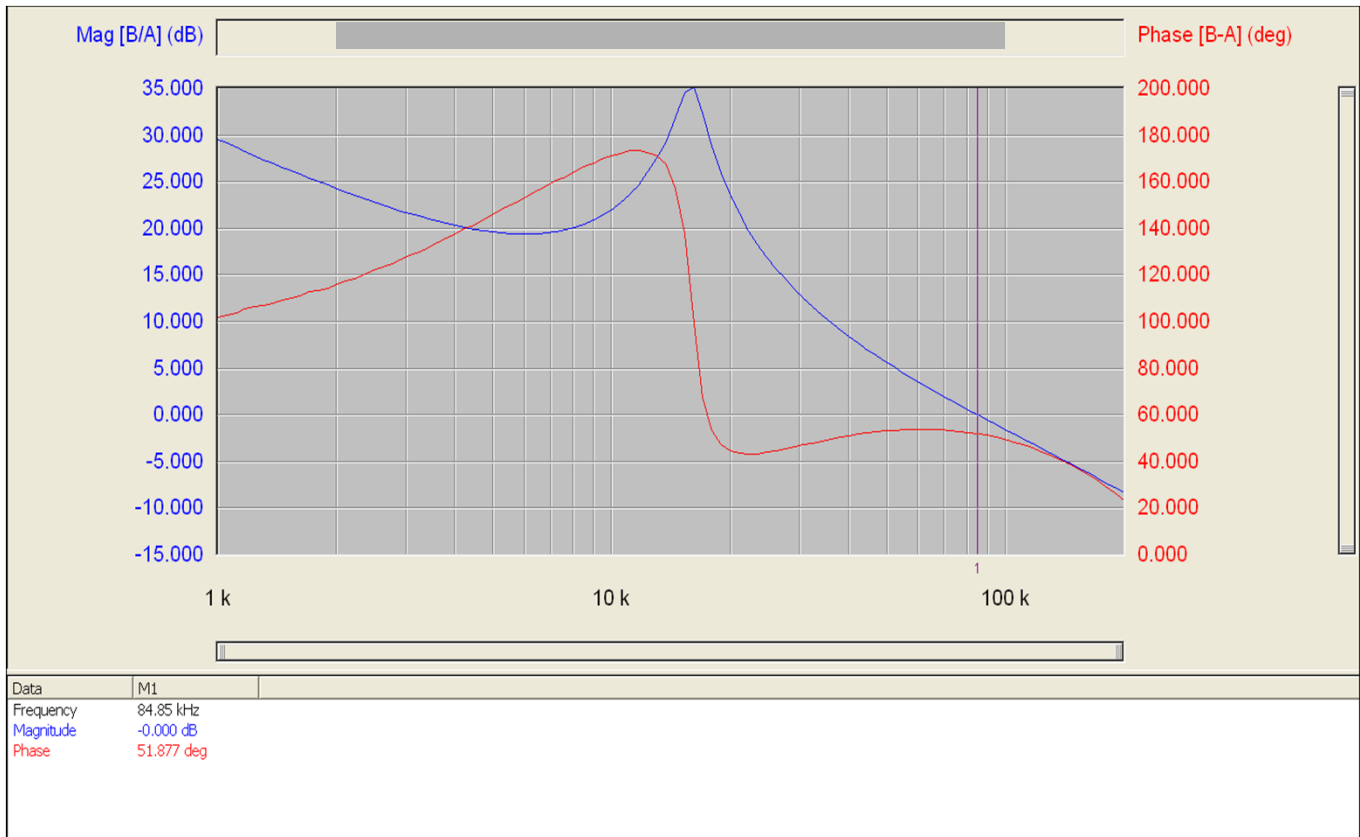

Fig.17: Bode Plot of CH1 at 4A load: Fo = 84.85 kHz; Phase Margin = 51.88°

**Bode Plot, Channel2**

Vin=12.0V, Vcc/LDO=5.3V, Vout<sub>1</sub>=1.8V, Vout<sub>2</sub>=1.2V, Io<sub>1</sub>= Io<sub>2</sub>=4A, Room Temperature, No air flow

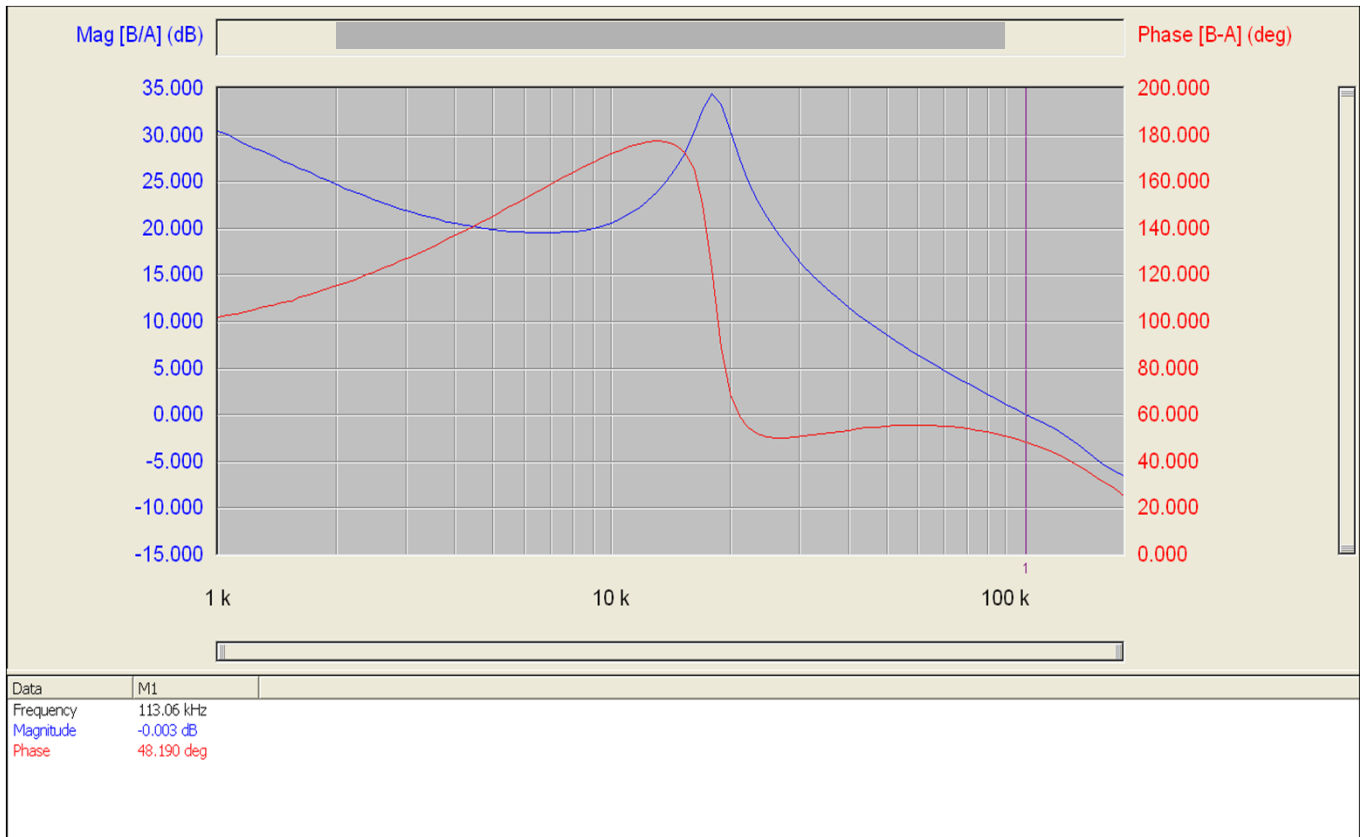

Fig.18: Bode Plot of CH2 at 4A load: Fo = 113.06 kHz; Phase Margin = 48.19°

Efficiency and Power Loss of channel1

Vin=12.0V, Vcc/LDO=5.3V, Vout<sub>1</sub>=1.8V, Vout<sub>2</sub> is disabled (EN2=low), I<sub>o1</sub>= 0-4A, Room Temperature, No air flow

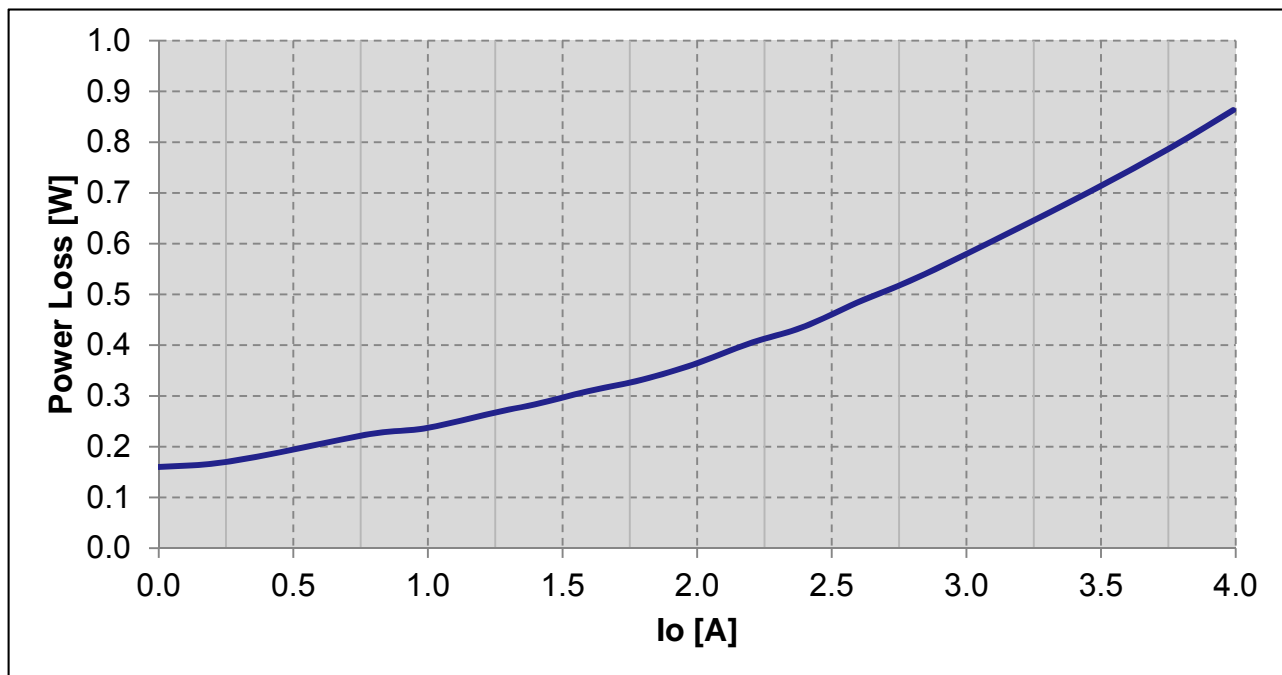
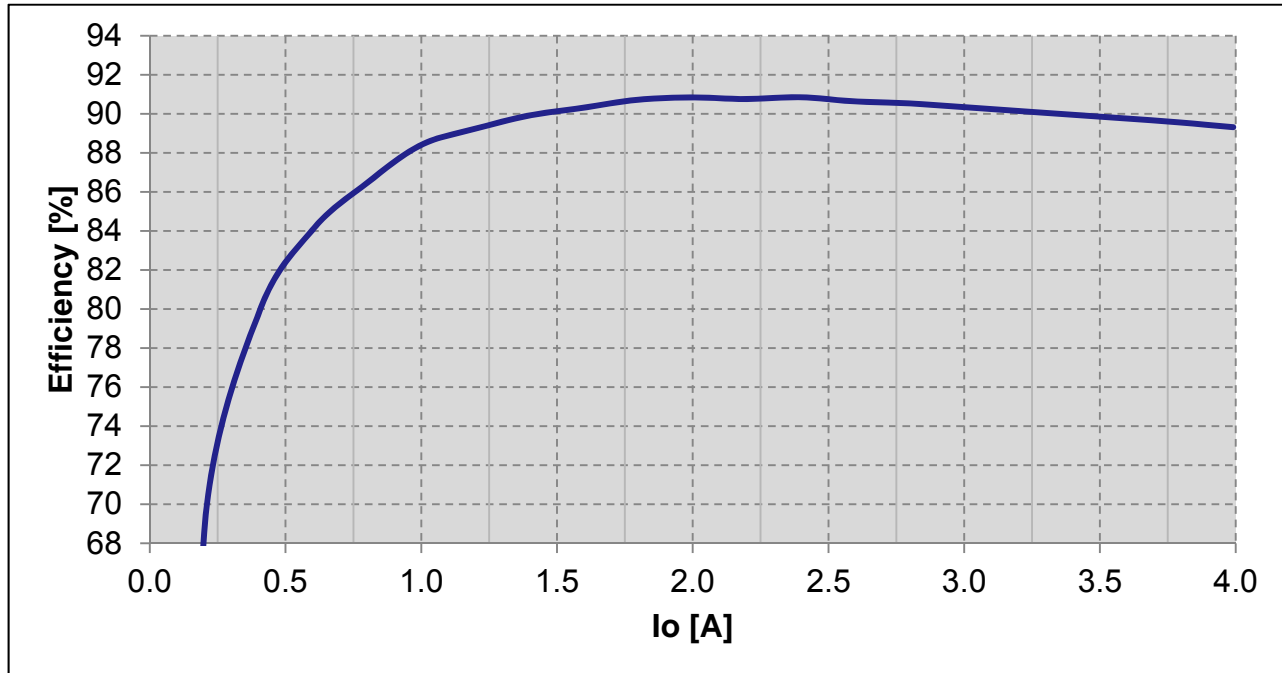

Fig.19: Efficiency and power loss vs. load current for channel1 (Vout<sub>1</sub> = 1.8V)

Efficiency and Power Loss of channel2

$V_{in}=12.0V$ ,  $V_{cc}/LDO=5.3V$ ,  $V_{out_1}$  is disabled (EN1=low),  $V_{out_2}=1.2V$ ,  $I_{o_2}=0-4A$ , Room Temperature, No air flow

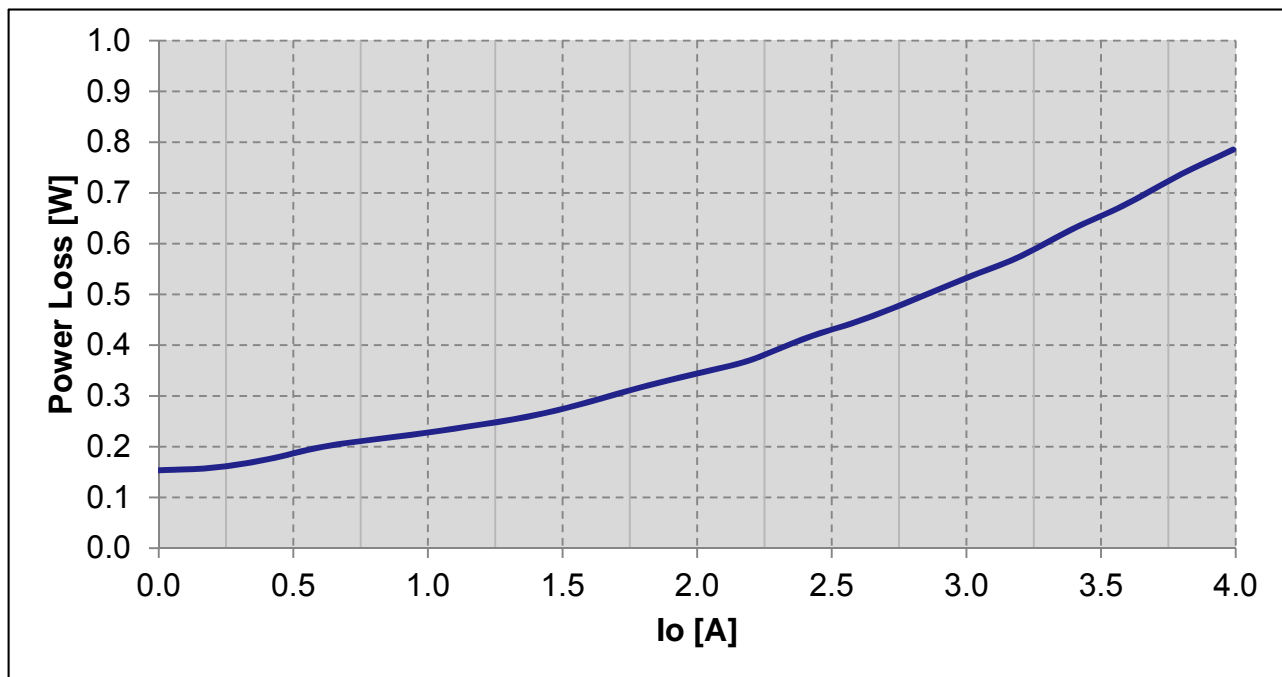
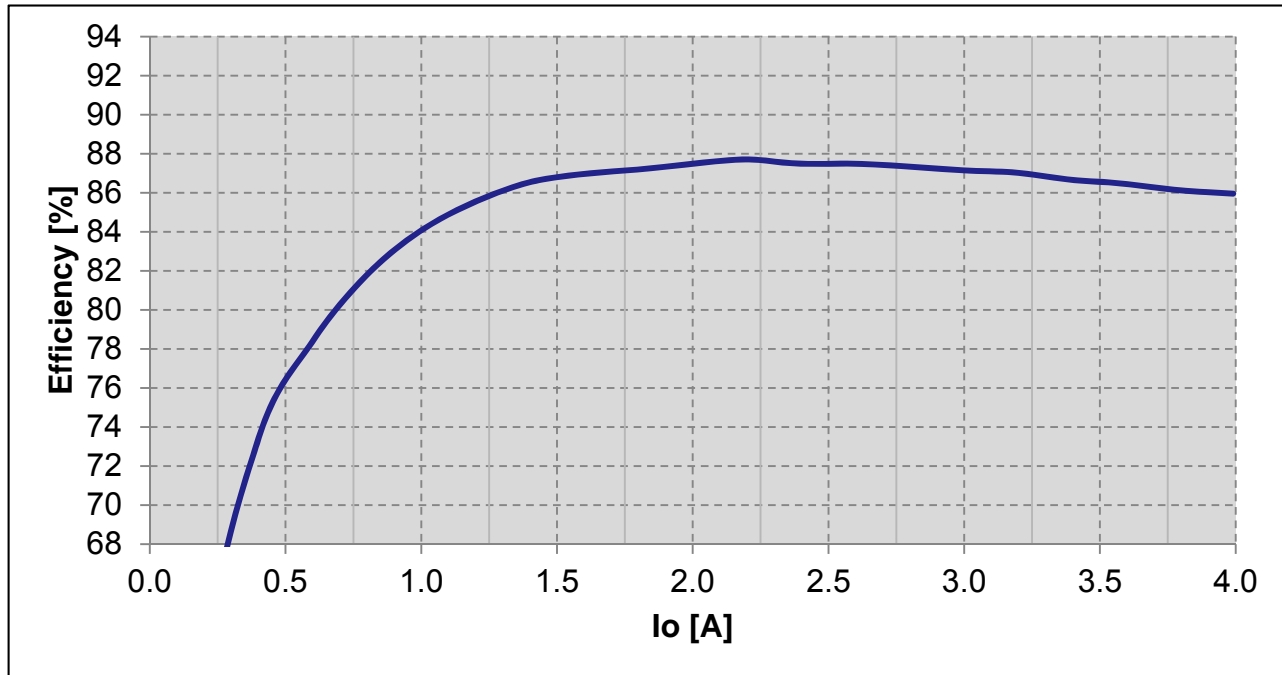

Fig.20: Efficiency and power loss vs. load current for channel2 ( $V_{out_2} = 1.2V$ )

Thermal Image

Vin=12.0V, Vcc/LDO=5.3V, Vout<sub>1</sub>=1.8V, Vout<sub>2</sub>=1.2V, I<sub>o1</sub>= I<sub>o2</sub>=4A, Room Temperature, No air flow

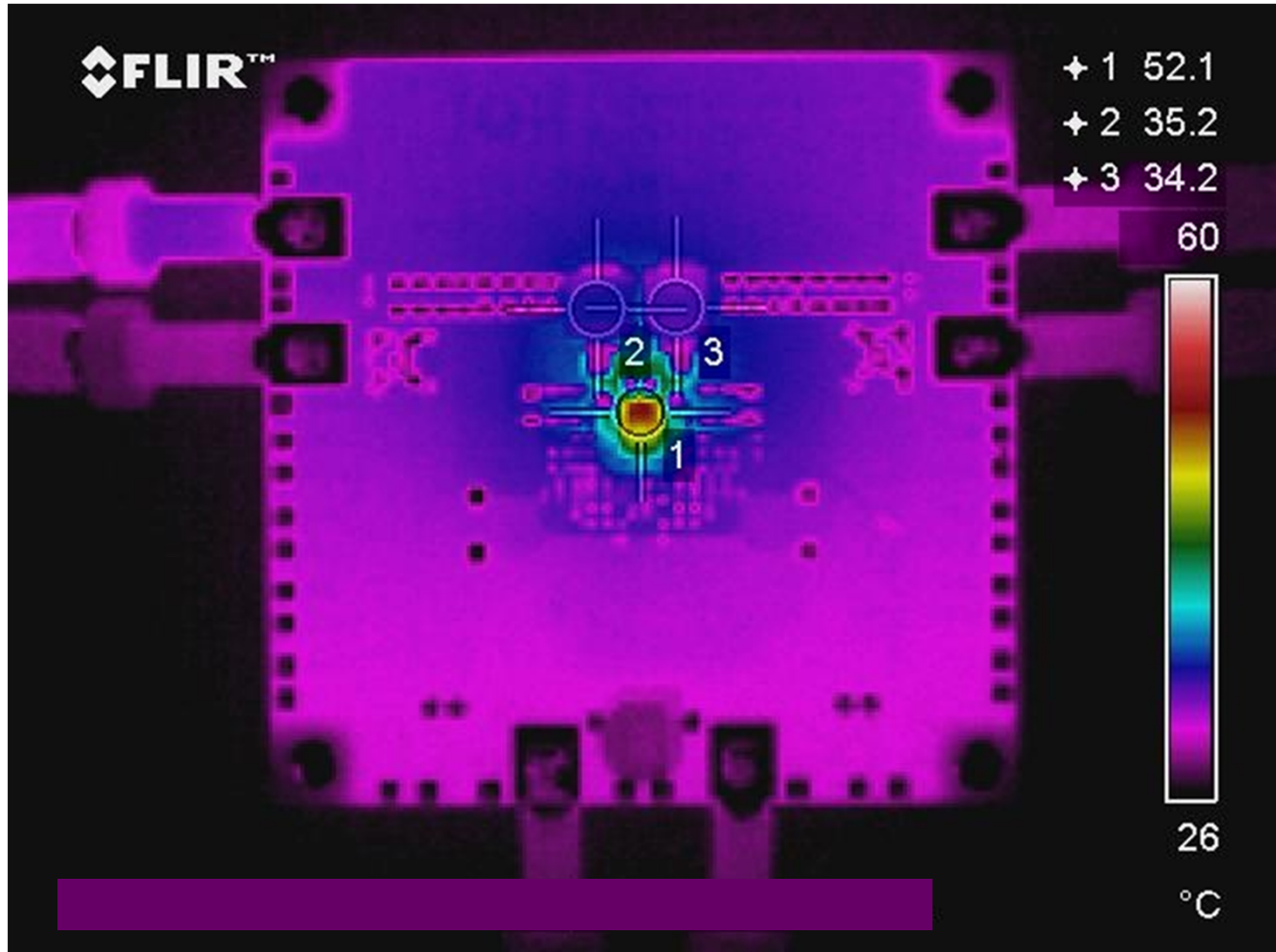

Fig.21: Thermal Image at I<sub>o1</sub>=I<sub>o2</sub>=4A load  
Test Point 1: IR3891, Test Point 2: Inductor\_Ch1, Test Point 3: Inductor\_Ch2

DIMENSIONS	Common					
	DIMENSIONS MILLIMETER			DIMENSIONS INCH		
	MIN.	NOM.	MAX.	MIN.	NOM.	MAX.
A	0.85	0.90	0.95	0.034	0.036	0.038
A3	0.203 REF.			0.008 REF.		
b	0.15	0.20	0.25	0.006	0.008	0.010
D	4.90	5.00	5.10	0.193	0.197	0.201
E	5.90	6.00	6.10	0.233	0.237	0.241
D2	3.26	3.31	3.36	0.129	0.131	0.133
E2	1.50	1.55	1.60	0.060	0.062	0.063
D3	1.20	1.25	1.30	0.048	0.050	0.052
E3	0.77	0.82	0.87	0.031	0.033	0.035
D4	1.43	1.48	1.53	0.057	0.059	0.061
E4	1.92	1.97	2.02	0.076	0.078	0.080
e	0.50 BSC			0.020 BSC		
L	0.35	0.40	0.45	0.014	0.016	0.018
L1	0.46	0.51	0.56	0.019	0.021	0.023

