

Basic Characteristics Data

Model	Circuit method	Switching frequency [kHz]	Input current *1 [A]	Inrush current protection	PCB/Pattern			Series/Parallel operation availability	
					Material	Single sided	Double sided	Series operation	Parallel operation
LMA100F	Active filter	60	1.4	Thermistor	CEM-3		Yes	Yes	No
	Forward converter	130							
LMA150F	Active filter	60	2.0	Thermistor	CEM-3		Yes	Yes	No
	Forward converter	130							
LMA240F	Active filter	60	3.9	SCR	CEM-3		Yes	Yes	No
	Forward converter	130							

*1 The value of input current is at ACIN 100V and rated load.

1	Function	LMA-10
1.1	Input voltage range	LMA-10
1.2	Inrush current limiting	LMA-10
1.3	Overcurrent protection	LMA-10
1.4	Overvoltage protection	LMA-10
1.5	Thermal protection	LMA-10
1.6	Output voltage adjustment range	LMA-10
1.7	Output ripple and ripple noise	LMA-10
1.8	Isolation	LMA-11
1.9	Reducing standby power	LMA-11
2	Series Operation and Parallel Operation	LMA-11
2.1	Series Operation	LMA-11
2.2	Parallel Operation	LMA-11
3	Assembling and Installation Method	LMA-11
3.1	Installation method	LMA-11
3.2	Derating	LMA-11
3.3	Mounting screw	LMA-13
3.4	Expectancy life and warranty	LMA-13
4	Ground	LMA-14
5	Option and Others	LMA-14
5.1	Outline of options	LMA-14
5.2	Others	LMA-15

1 Function

1.1 Input voltage range

- The range is from AC85V to AC264V or DC120V to DC370V (please see SPECIFICATIONS for details).
- In cases that conform with safety standard, input voltage range is AC100-AC240V (50/60Hz).
- If input value doesn't fall within above range, a unit may not operate in accordance with specifications and/or start hunting or fail. If you need to apply a square waveform input voltage, which is commonly used in UPS and inverters, please contact us.
- When the input voltage changes suddenly, the output voltage accuracy might exceed the specification. Please contact us.
- Operation stop voltage is set at a lower value than that of a standard version (derating is needed).

· Use Conditions

Output		*Please avoid using continuously for more than 1 second under above conditions. Doing so may cause a failure.
LMA100F	30W	
LMA150F	50W	
LMA240F	80W	

Input AC50V or DC70V
Duty 1s/30s

1.2 Inrush current limiting

- An inrush current limiting circuit is built-in.
- If you need to use a switch on the input side, please select one that can withstand an input inrush current.

● LMA100F, LMA150F

- Thermistor is used in the inrush current limiting circuit. When you turn the power ON/OFF repeatedly within a short period of time, please have enough intervals so that a power supply cools down before being turned on.

● LMA240F

- Thyristor technique is used in the inrush current limiting circuit. When you turn power ON/OFF repeatedly within a short period of time, please have enough intervals so that the inrush current limiting circuit becomes operative.
- When the switch of the input is turned on, the primary inrush current and secondary inrush current will be generated because the thyristor technique is used for the inrush current limiting circuit.

1.3 Overcurrent protection

- An overcurrent protection circuit is built-in and activated at 105% of the rated current. A unit automatically recovers when a fault condition is removed. Please do not use a unit in short circuit and/or under an overcurrent condition.
- Please don't use continuously in constant current mode with over current protection (Ex: for Battery charging), which might lead to internal parts damage.
- In case of using in constant current mode, please refer to 5.1, -P option.

1.4 Overvoltage protection

- An overvoltage protection circuit is built-in. If the overvoltage protection circuit is activated, shut down the input voltage, wait more than 3 minutes and turn on the AC input again to recover the output voltage. Recovery time varies depending on such factors as input voltage value at the time of the operation.
- In option -R2, overvoltage protection is removed by toggling ON/OFF signal of remote control.

Remarks :

Please avoid applying a voltage exceeding the rated voltage to an output terminal. Doing so may cause a power supply to malfunction or fail. If you cannot avoid doing so, for example, if you need to operate a motor, etc., please install an external diode on the output terminal to protect the unit.

1.5 Thermal protection

- A thermal protection circuit is built-in. The thermal protection circuit may be activated under the following conditions and shut down the output.
 - ① When a temperature continue to exceed the values determined by the derating curve.
 - ② When a current exceeding the rated current is applied.
 - ③ When convection stops.

If the thermal protection circuit is activated, shut off the input voltage and eliminate all the overheating conditions. To recover the output voltage, have enough time to cool down the unit before turning on the input voltage again.

1.6 Output voltage adjustment range

- Adjustment of output voltage is possible by using potentiometer.

1.7 Output ripple and ripple noise

- Output ripple noise may be influenced by measurement environment, measuring method fig.1.1 is recommended.

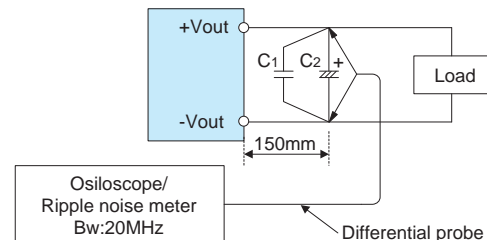

C1 : Film capacitor 0.1µF
C2 : Aluminum electrolytic capacitor 22µF

Fig.1.1 Measuring method of Ripple and Ripple Noise

Remarks :

When GND cable of probe with flux of magnetic force from power supply are crossing, ripple and ripple noise might not measure correctly. Please note the measuring environment.

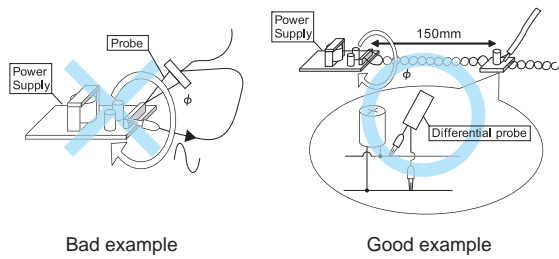

Fig.1.2. Example of measuring output ripple and ripple noise

1.8 Isolation

■For a receiving inspection, such as Hi-Pot test, gradually increase (decrease) the voltage for the start (shut down). Avoid using Hi-Pot tester with the timer because it may generate voltage a few times higher than the applied voltage, at ON/OFF of a timer.

1.9 Reducing standby power

■As for option -R2, reducing standby power is possible by OFF signal of the remote control.
Please refer to instruction manual 6.1.

2 Series Operation and Parallel Operation

2.1 Series Operation

■You can use a power supply in series operation. The output current in series operation should be lower than the rated current of a power supply with the lowest rated current among power supplies that are serially connected. Please make sure that no current exceeding the rated current flows into a power supply.

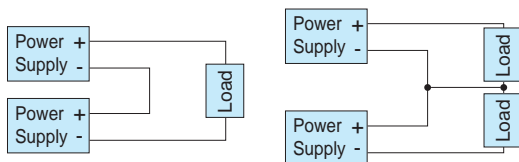

Fig.2.1 Examples of connecting in series operation

2.2 Parallel Operation

■Parallel operation is not possible.
■Redundancy operation is available by wiring as shown below.

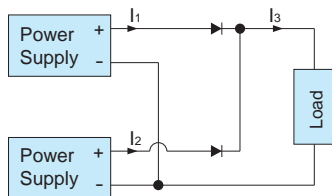

Fig.2.2 Example of redundancy operation

■Even a slight difference in output voltage can affect the balance between the values of I_1 and I_2 . Please make sure that the value of I_3 does not exceed the rated current of a power supply.

$$I_3 \leq \text{the rated current value}$$

3 Assembling and Installation Method

3.1 Installation method

■This power supply is manufactured by SMD technology. The stress to P.C.B like twisting or bending causes the defect of the unit,so handle the unit with care.
■In case of metal chassis, keep the distance between d_1 & d_2 for to insulate between lead of component and metal chassis, use the spacer of 8mm or more between d_1 . If it is less than d_1 & d_2 , insert the insulation sheet between power supply and metal chassis.

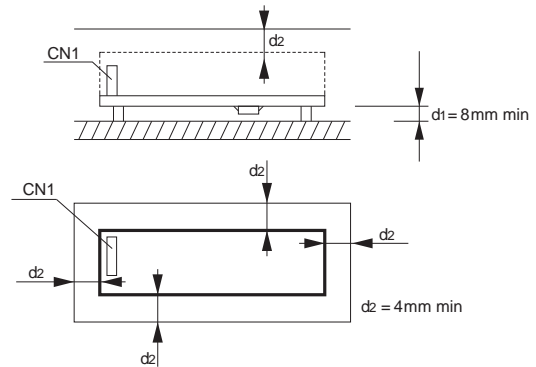

Fig.3.1 Installation method

■There is a possibility that it is not possible to cool enough when the power supply is used by the sealing up space as showing in Figure 3.2. Please use it after confirming the temperature of point A and point B of Instruction Manual 3.2.

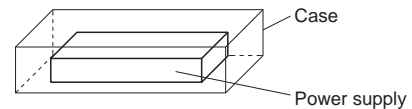

Fig.3.2 Installation example

3.2 Derating

■Environment to use it and Installation environment
When using it,it is necessary to radiate heat by the heat of the power supply.
Table 3.1 - 3.4 shows the relation between the upper limit temperature (Point A and Point B) and load factors.
Please consider the ventilation so that the convection which is enough for the whole power supply is provided.
And temperature of Point A and Point B please become lower than upper limit temperature.

The expectancy life in the upper bound temperature (Point A and Point B) is three years or more.

Please refer to External View for the position of Point A and Point B. In case of with Chassis and Cover, please contact our sales office for getting more information.

Remarks:

*Please be careful of electric shock or earth leakage in case of temperature measurement, because Point A and Point B is live potential.

*Please refer to 3.4 if you want to extend the longevity of the expectancy life.

Table 3.1 Temperatures of Point A, Point B LMA100F-24-Y

Mounting Method	Cooling Method	Load factor	Max temperature	
			Point A[°C]	Point B[°C]
A	Convection	75%<l _o ≤100%	87	75
		50%<l _o ≤75%	86	77
		0%<l _o ≤50%	89	83
B	Convection	75%<l _o ≤100%	80	76
		50%<l _o ≤75%	81	78
		0%<l _o ≤50%	86	86
C	Convection	75%<l _o ≤100%	84	85
		50%<l _o ≤75%	85	86
		0%<l _o ≤50%	86	88
D	Convection	75%<l _o ≤100%	79	62
		50%<l _o ≤75%	83	68
		0%<l _o ≤50%	86	75
E	Convection	75%<l _o ≤100%	82	86
		50%<l _o ≤75%	83	89
		0%<l _o ≤50%	82	89
F	Convection	75%<l _o ≤100%	77	66
		50%<l _o ≤75%	87	80
		0%<l _o ≤50%	84	78
A,B,C,D,E,F	Forced air	70%<l _o ≤100%	75	75
		0%<l _o ≤70%	75	75

Table 3.2 Temperatures of Point A, Point B LMA150F-24-Y

Mounting Method	Cooling Method	Load factor	Max temperature	
			Point A[°C]	Point B[°C]
A	Convection	75%<l _o ≤100%	82	66
		50%<l _o ≤75%	89	78
		0%<l _o ≤50%	89	82
B	Convection	75%<l _o ≤100%	73	62
		50%<l _o ≤75%	86	77
		0%<l _o ≤50%	86	80
C	Convection	75%<l _o ≤100%	86	74
		50%<l _o ≤75%	89	80
		0%<l _o ≤50%	89	84
D	Convection	75%<l _o ≤100%	76	67
		50%<l _o ≤75%	76	73
		0%<l _o ≤50%	79	79
E	Convection	75%<l _o ≤100%	80	84
		50%<l _o ≤75%	84	89
		0%<l _o ≤50%	83	89
F	Convection	75%<l _o ≤100%	71	60
		50%<l _o ≤75%	79	72
		0%<l _o ≤50%	82	78
A,B,C,D,E,F	Forced air	70%<l _o ≤100%	75	75
		0%<l _o ≤70%	75	75

Table 3.3 Temperatures of Point A, Point B, Point C LMA240F-24-Y

Mounting Method	Cooling Method	Load factor	Max temperature		
			Point A[°C]	Point B[°C]	Point C[°C]
A	Convection	75%<l _o ≤100%	74	70	
		50%<l _o ≤75%	82	78	
		0%<l _o ≤50%	89	86	
B	Convection	75%<l _o ≤100%	71	68	
		50%<l _o ≤75%	83	79	
		0%<l _o ≤50%	84	81	
C	Convection	75%<l _o ≤100%	64	61	
		50%<l _o ≤75%	76	72	
		0%<l _o ≤50%	76	83	
D	Convection	75%<l _o ≤100%	59	57	
		50%<l _o ≤75%	68	68	
		0%<l _o ≤50%	76	76	
E	Convection	75%<l _o ≤100%	77	57	
		50%<l _o ≤75%	83	68	
		0%<l _o ≤50%	89	73	
F	Convection	75%<l _o ≤100%	83	69	
		50%<l _o ≤75%	86	77	
		0%<l _o ≤50%	89	82	
A,B,C,D,E,F	Forced air	70%<l _o ≤100%	75	75	85
		0%<l _o ≤70%	75	75	85

■The operative ambient temperature is different by with / without chassis cover or mounting position. Derating curve is shown below. Note: In the hatched area, the specification of Ripple, Ripple Noise is different from other area.

● LMA100F

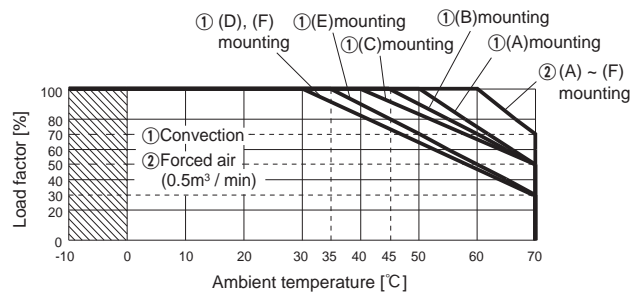

Fig.3.3 Ambient temperature derating curve (refer to Table 3.1)

● LMA150F

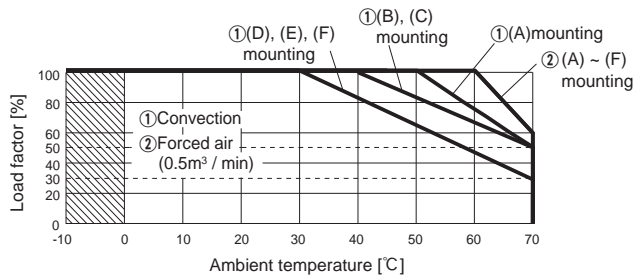
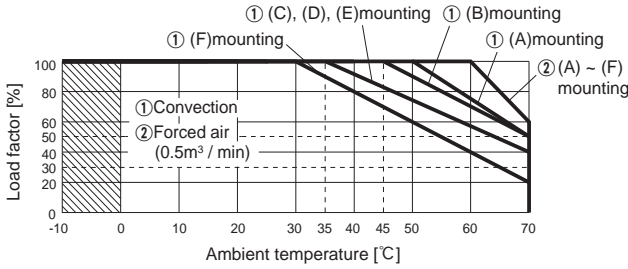

Fig.3.4 Ambient temperature derating curve (refer to Table 3.2)

● LMA240F



Output voltage	Output power[W]	
	①Convection	②Forced air
24V	240.0	300.0

Fig.3.5 Ambient temperature derating curve (refer to Table 3.3)

■ Derating curve depending on input voltage

Derating curve depending on input voltage is shown in Fig.3.6.

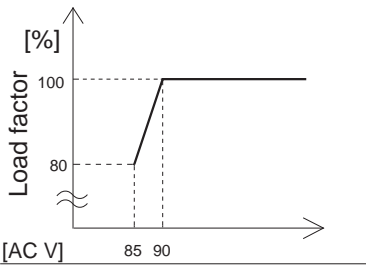

Fig.3.6 Derating curve depending on input voltage

■ Mounting method

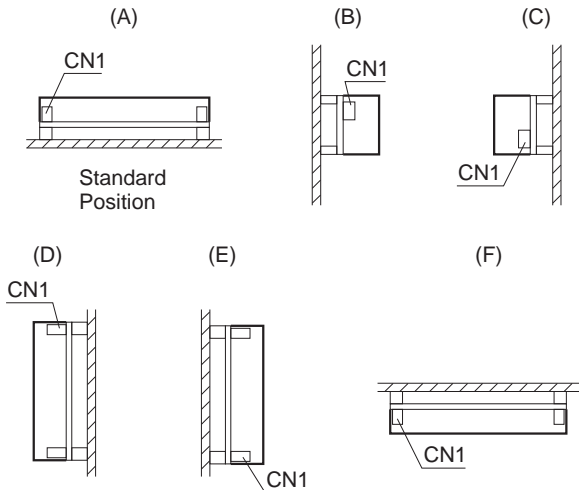

Fig.3.7 Mounting method

■ (F) mounting is not possible when unit is with case cover, but if need to operate unit by (F) positioning with case cover, temperature / load derating is necessary. For more details, please contact our sales or engineering departments.

3.3 Mounting screw

■ The mounting screw should be M3. The hatched area shows the allowance of metal parts for mounting.

■ If metallic fittings are used on the component side of the board, ensure there is no contact with surface mounted components.

■ This product uses SMD technology.

Please avoid the PCB installation method which includes the twisting stress or the bending stress.

* Recommendation to electrically connect FG to metal chassis for reducing noise.

● LMA100F, LMA150F

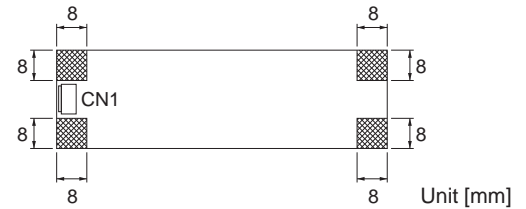

Fig.3.8 Allowance of metal for mounting

● LMA240F

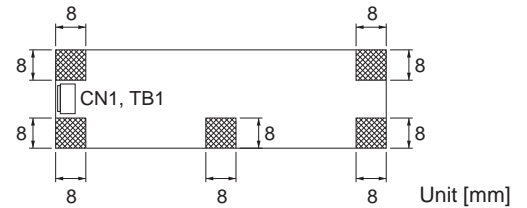

Fig.3.9 Allowance of metal for mounting

3.4 Expectancy life and warranty

■ Expectancy Life.

Table 3.4 Expectancy Life (LMA100F-24-Y)

Mounting Method	Cooling Method	Average ambient temperature (year)	Expectancy Life	
			lo ≤ 75%	75% < lo ≤ 100%
A	Convection	Ta = 40°C or less	6years	6years
		Ta = 50°C	6years	4years
B	Convection	Ta = 45°C	6years	6years
C	Convection	Ta = 30°C or less	6years	6years
		Ta = 40°C	6years	4years
D, F	Convection	Ta = 30°C	6years	6years
E	Convection	Ta = 35°C or less	6years	6years
A,B,C,D,E,F	Forced air	Ta = 60°C	6years	4years

Table 3.5 Expectancy Life (LMA150F-24-Y)

Mounting Method	Cooling Method	Average ambient temperature (year)	Expectancy Life	
			lo ≤ 75%	75% < lo ≤ 100%
A	Convection	Ta = 40°C or less	6years	6years
		Ta = 50°C	6years	4years
B, C	Convection	Ta = 40°C or less	6years	6years
D, E	Convection	Ta = 30°C or less	6years	6years
F	Convection	Ta = 30°C or less	6years	4years
A,B,C,D,E,F	Forced air	Ta = 60°C	6years	4years

Table 3.6 Expectancy Life (LMA240F-□-Y)

Mounting Method	Cooling Method	Average ambient temperature (year)	Expectancy Life	
			Io ≤ 75%	75% < Io ≤ 100%
A	Convection	Ta = 50°C or less	6years	6years
B	Convection	Ta = 35°C or less	6years	6years
		Ta = 45°C	6years	4years
C, D	Convection	Ta = 35°C or less	6years	6years
E	Convection	Ta = 25°C or less	6years	6years
		Ta = 35°C	6years	4years
F	Convection	Ta = 30°C or less	6years	6years
A,B,C,D,E,F	Forced air	Ta = 60°C	6years	4years

Warranty

Table 3.7 Warranty (LMA100F-24-Y)

Mounting Method	Cooling Method	Average ambient temperature (year)	Warranty	
			Io ≤ 75%	75% < Io ≤ 100%
A	Convection	Ta = 40°C or less	5years	5years
		Ta = 50°C	5years	3years
B	Convection	Ta = 45°C or less	5years	5years
C	Convection	Ta = 30°C or less	5years	5years
		Ta = 40°C	5years	3years
D, F	Convection	Ta = 30°C or less	5years	5years
E	Convection	Ta = 35°C or less	5years	5years
A,B,C,D,E,F	Forced air	Ta = 60°C	5years	3years

Table 3.8 Warranty (LMA150F-24-Y)

Mounting Method	Cooling Method	Average ambient temperature (year)	Warranty	
			Io ≤ 75%	75% < Io ≤ 100%
A	Convection	Ta = 40°C or less	5years	5years
		Ta = 50°C	5years	3years
B, C	Convection	Ta = 40°C or less	5years	5years
D, E	Convection	Ta = 30°C or less	5years	5years
F	Convection	Ta = 30°C or less	5years	3years
A,B,C,D,E,F	Forced air	Ta = 60°C	5years	3years

Table 3.9 Warranty (LMA240F-24-Y)

Mounting Method	Cooling Method	Average ambient temperature (year)	Warranty	
			Io ≤ 75%	75% < Io ≤ 100%
A	Convection	Ta = 50°C or less	5years	5years
B	Convection	Ta = 35°C or less	5years	5years
		Ta = 45°C	5years	3years
C, D	Convection	Ta = 35°C or less	5years	5years
E	Convection	Ta = 25°C or less	5years	5years
		Ta = 35°C	5years	3years
F	Convection	Ta = 30°C or less	5years	5years
A,B,C,D,E,F	Forced air	Ta = 60°C	5years	3years

4 Ground

When installing the power supply with your unit, ensure that the input FG terminal of CN1 or mounting hole FG is connected to safety ground of the unit.

LMA

5 Option and Others

5.1 Outline of options

-C

- Option -C units have coated internal PCB for better moisture resistance.

-G

- Option -G units are low leakage current type.
- Differences from standard versions are summarized in Table 5.1.

Table 5.1 Low leakage current type

Leakage Current (AC100V 60Hz)	0.05mA max
Conducted Noise	N/A
Output Ripple Noise	Please contact us for details about Ripple Noise

* This is the value that measured on measuring board with capacitor of 22μF at 150mm from output connector.

Measured by 20MHz oscilloscope or Ripple-Noise meter (Equivalent to KEISOKU-GIKEN:RM-103).

-H

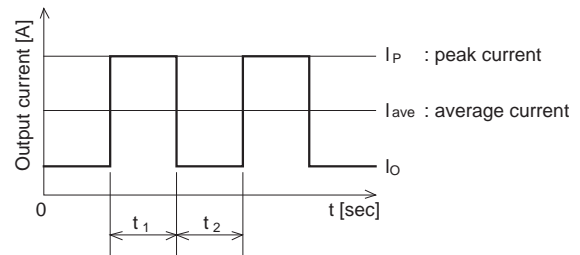

$$t_1 \leq 10 \text{ [sec]}, \quad I_{ave} = \frac{I_p t_1 + I_o t_2}{t_1 + t_2} \leq \text{rated current},$$

$$\frac{t_1}{t_1 + t_2} \leq 0.40 \text{ (Refer to below chart)}$$

Duty is depended on peak load, refer to below chart.

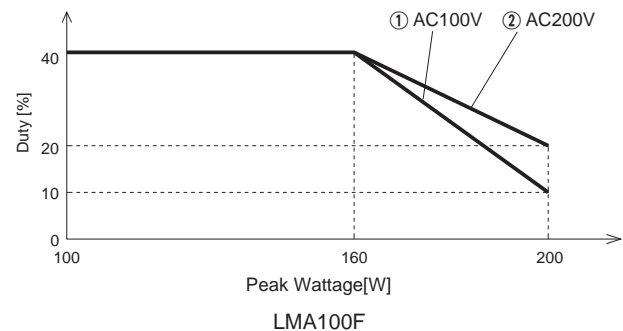

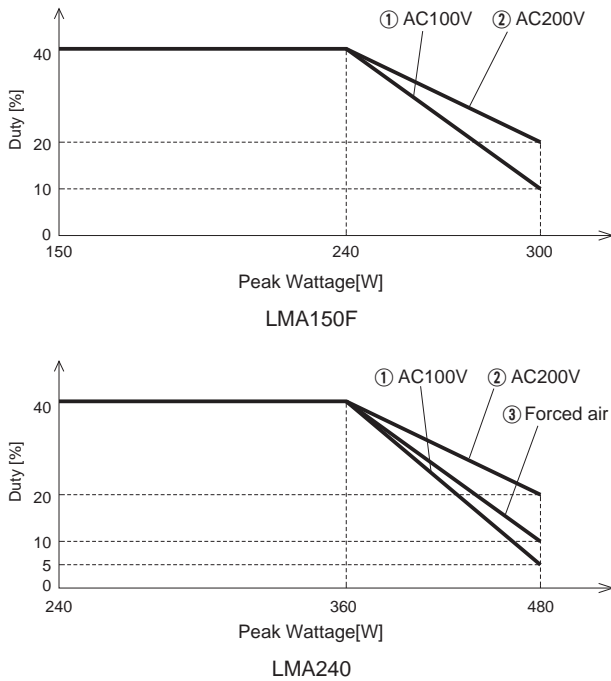

Fig.5.1 Derating of peak loading

-S · -SN

- S indicates a type with chassis, and -SN indicates a type with chassis and cover (Refer to external view). Please contact us about the detail of derating curve.

-R

- You can control output ON/OFF remotely in Option -R units. To do so, connect an external DC power supply and apply a voltage to a remote ON/OFF connector, which is available as option.

Model Name	Built-in Resistor Ri [Ω]	Voltage between RC (+) and RC (-) [V]		Input Current [mA]
		Output ON	Output OFF	
LMA100F, LMA150F, LMA240F	780	4.5 - 12.5	0 - 0.5	20max

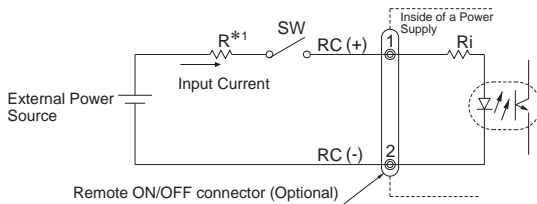

Fig.5.2 Example of using a remote ON/OFF circuit

- Dedicated harnesses are available for your purchase. Please see Optional Parts for details.
- *1 If the output of an external power supply is within the range of 4.5 - 12.5V, you do not need a current limiting resistor R. If the output exceeds 12.5V, however, please connect the current limiting resistor R.

To calculate a current limiting resistance value, please use the following equation.

$$R[\Omega] = \frac{V_{cc} - (1.1 + R_i \times 0.005)}{0.005}$$

- *Please wire carefully. If you wire wrongly, the internal components of a unit may be damaged.
- Remote ON/OFF circuits (RC+ and RC-) are isolated from input, output and FG.

-R2

- The usage is the same as option -R, please refer to Option -R.
- Reducing standby power is possible by OFF signal of the remote control.
- Start up time by ON signal in remote control is 350ms(typ).
- The latch condition in overvoltage protection is removed by toggling ON/OFF signal of remote control.
- Standby power
LMA100F, LMA150F, LMA240F
0.2W/typ (AC100V), 0.7W/typ (AC200V)

-P

- Constant current mode for battery charging is possible by setting the over current activation point within rated output current.
- Over current activation point varies depending on output voltage setting as shown in Table 5.2.
- Parallel operation is not possible.

Table 5.2 Overcurrent protection *

Model	Output voltage setting [V]	Overcurrent protection [A]
LMA100F-24-PY	19.2 ≤ Vo < 21.6	2.5 - 4.2
	21.6 ≤ Vo < 26.4	2.2 - 4.0
	26.4 ≤ Vo < 27.5	2.1 - 3.8
LMA150F-24-PY	19.2 ≤ Vo < 21.6	4.3 - 6.2
	21.6 ≤ Vo < 26.4	4.1 - 6.1
LMA240F-24-PY	19.2 ≤ Vo < 21.6	7.2 - 9.9
	21.6 ≤ Vo < 26.4	6.9 - 9.7
	26.4 ≤ Vo < 27.5	6.7 - 9.5

*-P option can not generate rated output current as shown on label.

5.2 Others

- This power supply is the rugged PCB type. Do not drop conductive objects in the power supply.
- At light load, there remains high voltage inside the power supply for a few minutes after power OFF. So, at maintenance, take care about electric shock.
- This power supply is manufactured by SMD technology. The stress to PCB like twisting or bending causes the defect of the unit, so handle the unit with care.
 - Tighten all the screws in the screw hole.
 - Install it so that PCB may become parallel to the clamp face.
 - Avoid the impact such as drops.
- While turning on the electricity, and for a while after turning off, please don't touch the inside of a power supply because there are some hot parts in that.
- When a mass capacitor is connected with the output terminal (load side), the output might become the stop or an unstable operation. Please contact us for details when you connect the capacitor.