



Operation Manual

Water-Water Cooler WW 5001



Version 1.0

Laird Technologies GmbH
Borsigstrasse 1
D-24568 Kaltenkirchen
www.lairdtech.com

Protection Notice

Dissemination as well as copying of this document, utilization or posting of its contents is not permitted unless formally granted. Violations entail claims for compensation. All copyrights, including rights due to patent grant or registration of a utility model or design, are reserved.

All product names used in this manual are trademarks of the corresponding manufacturers.

Technical modifications are subject to change.

Table of Contents

1	About this Manual	6
1.1	Terms of Guarantee.....	6
1.2	Contact Information.....	7
2	Product Identification.....	8
2.1	Unit Specifications.....	8
2.2	Identification Plate	8
3	Safety Regulations.....	9
3.1	Hazard classes.....	9
3.2	Safety Symbols	9
3.3	Hints for Safe Operation	10
3.3.1	Prevent Hazards	10
3.3.2	Hints Regarding the Electrical Equipment.....	11
3.3.3	Environmental Issues.....	11
3.3.4	Exclusion Criteria	11
3.4	Safety Equipment.....	12
3.4.1	Safety and Signalling Equipment included in the Unit.....	12
3.4.2	Guards.....	13
3.4.3	Caution Labels	13
3.5	In Case of Accidents.....	14
4	Product Description	15
4.1	Intended Use	15
4.2	Non-Conformity with the Intended Use.....	15
4.3	Unit Components.....	16
4.3.1	Functional principle	16
4.4	Specifications.....	17
4.5	Setting-up Requirements.....	18
4.5.1	Installation Location.....	18
4.5.2	Environmental Conditions.....	18
4.5.3	Infrastructure	18
5	Transport.....	19

- 5.1 Safety Indications for Transportation and Setting-up 19
- 5.2 Transportation of the Unit 19
- 5.3 Unpacking and Disposal of Packaging Material 19

- 6 Initial Operation..... 20
 - 6.1 Safety Indications Related to Initial Operation 20
 - 6.2 Setting to Work 20
 - 6.2.1 Placement 20
 - 6.2.2 Cooling Circuit Connection and Filling..... 21
 - 6.2.3 Electrical Connections 22
 - 6.2.4 Carrying out Setting to Work..... 23
 - 6.3 Daily Start-up 23
 - 6.4 Setting to work after Storage 23

- 7 Controlling the Unit 24
 - 7.1 Safety Indications for Controlling the Unit 24
 - 7.2 Switching-on the Unit 24
 - 7.3 Switching-off the Unit 24
 - 7.4 Settings..... 25
 - 7.4.1 Flow Control Device 25
 - 7.4.2 By-pass Valve 25
 - 7.4.3 Temperature Controller 25

- 8 Disruptions..... 28
 - 8.1 Safety Instructions in the Event of Malfunction 28
 - 8.2 Disruption in Operation..... 28
 - 8.2.1 Trouble Shooting..... 29

- 9 Maintenance and Cleaning 30
 - 9.1 Maintenance Schedule..... 30
 - 9.2 Refilling of Coolant..... 30
 - 9.3 Cleaning of Strainer..... 31
 - 9.4 Cleaning of Unit Body 32

- 10 Repair 32
 - 10.1 Safety Instuctions on Repair 32
 - 10.2 Repair Procedures..... 32

11 Dismounting, Disposal, Storage..... 33

 11.1 Temporary Placing out of Operation 33

 11.2 Re-packaging of the unit..... 34

 11.3 Storing the Unit..... 34

 11.4 Disposal 34

 11.5 Disposal of Operating Materials..... 34

 11.6 Return of the unit to LAIRD 34

12 Wear Parts and Spare Parts 35

 12.1 General Information 35

 12.2 Parts Overview..... 36

Addendum 37

 Flow scheme 37

 Wiring diagram..... 38

History of Changes

Date	Index	Reason for Change	Name	Page
28-October-2015	1.0		Dany/Bitenaite	

1 About this Manual

This document is the English translation of the original Operation Manual in German language for the Water-Water Cooler WW 5001 (called unit in the following). It is based on German safety regulations. In your country other regulations may apply.

This Operational Manual addresses the needs of the user of the unit. Its intention is to allow the safe operation of the unit. Thus, it should be read carefully and be kept in a space accessible for the users of the unit at any time.

All chapters of this Operation Manual can be read independently and thus can be used for look-up purposes.

1.1 Terms of Guarantee

General sale and delivery terms of LAIRD apply. The buyer accepts these terms, at the latest when signing the contract of purchase.

The particular terms of guarantee and duration of guarantee of the device in question can be taken from the contract documents as well as from the order confirmation.

Warranty claims and liability are excluded in case of one of the following situations:

- Use of the unit in an unintended way
- Inaccurate installation, putting into service, operation, repair or maintenance of the product by people that are not fully authorized
- Use of the product despite of defect, wrongly implemented or non-functional safety devices or protective gear
- Unauthorized or forbidden modifications by the user concerning the electrical equipment of the unit
- Unauthorized or forbidden modifications by the user concerning the mechanical structure of the unit
- Unauthorized or forbidden modifications by the user concerning the operating parameters
- Use of unauthorized tools
- Use of unauthorized operating supplies
- Exceedance of mandatory maintenance intervals
- Cases of disaster caused by foreign matter influence or act of nature beyond control

PLEASE NOTE

Any form of unintended use of the unit and any structural change caused by the user without prior authorization in written form by LAIRD will lead to the termination of warranty as well the termination of the declaration of conformation and will free LAIRD from product liability. This concern includes safety devices as well.

In case of authorized changes or when adding optional equipment it is the sole responsibility of the customer to assure the accurate implementation of the required safety devices.

1.2 Contact Information

If you have questions with respect to this unit please use the contact information given below. Always communicate the following:

- Your name and address
- Name of contact at your address
- Product data as on identification plate: Type of unit, serial number and year of manufacture

Company contact:

Mail: Laird Technologies GmbH
Borsigstrasse 1
D-24568 Kaltenkirchen
Deutschland

Internet: <http://www.lairdtech.com>

E-Mail: info-lcs@lairdtech.com

Phone: +49 (0)4191 9993-0

Fax: +49 (0)4191 9993-33

2 Product Identification

2.1 Unit Specifications

Manufacturer	Laird Technologies GmbH
Type of product	Water-water cooler
Type of unit	WW 5001
Article number	1109.00

Table 1: Unit specifications

2.2 Identification Plate

The identification plate is attached to the front side of the unit (see picture 1).

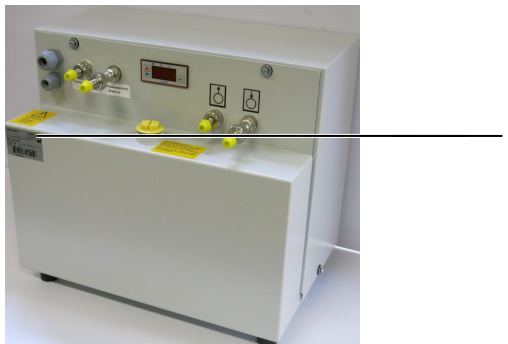

Fig. 1: Position of identification plate

1	Identification plate
---	----------------------



Fig. 2: Unit specific identification plate

1	Unit type	2	Date of manufacture
3	Article number	4	Serial number
5	Electrical specification		

3 Safety Regulations

3.1 Hazard classes

In this document safety instructions are using standardized representation and symbols. Depending on the probability of their incidence and the severeness of consequences three hazard classes are used.



DANGER

Reference to direct danger for humans.
Inobservance will lead to irreversible injuries or exitus.



CAUTION

Reference to noticeable danger for humans or possible damage to property.
Inobservance may lead to reversible injuries or to damage to property.

3.2 Safety Symbols

In this Operation Manual concrete safety instructions are given in order to point out unpreventable residual risks when operating the device. These risks include danger for

- Human beings
- The device and other equipment
- The environment

The safety symbols used in this manual are indicated below. The main reason for their use is to point the reader to the safety instruction given in the text field beside.



Symbol	Meaning
	Warning with respect to general danger or damage to property
	Warning with respect to electrical hazard

Table 2: Warning signs

Symbol	Meaning
	This symbol indicates the requirement of disconnecting from mains

Table 3: Signs giving orders

3.3 Hints for Safe Operation

PLEASE NOTE

Conduct inspections on a regular time base.

This will ensure that the appropriate measures will actually be carried out.

The unit is operational safe. It was built according to the state-of-the-art.

Despite this the unit could cause hazards if it

- is used in a way it was not intended for
- is used improperly
- is operated under unsuitable conditions

3.3.1 Prevent Hazards

Hazards can be prevented by safety-conscious and anticipatory behaviour of staff.

Everybody working with the unit should keep the following in mind:

- Make this Operation Manual available for everybody at the operational location of the unit in a complete and perfectly readable state!
- Use the unit exclusively for what it was intended!
- The unit must be operational and errorfree. Check the condition of the unit before working with it and within a regular time frame!
- Make sure that nobody can injure himself by any part of the unit!
- Any disruption or recognizable change concerning the unit should be reported to the responsible person!
- Stick to the accident prevention regulations as well as any regional regulations!

3.3.2 Hints Regarding the Electrical Equipment



DANGER

Danger to life through electrical shock when working on the electrical equipment of the unit!

- Switch-off the unit before starting your work!
- Disconnect the unit from mains by pulling the mains plug!
- Verify that the installation is dead (volt-free)!
- Carry out earthing or short-circuiting!



When working on electrical installations the following principles should be observed:

- Works on the electrical installations may only be accomplished by qualified electrical staff.
- When connecting electrical equipment to mains regional regulations have to be observed. Be aware of the wiring diagram information.
- The unit is powered by electricity. Electrical shock hazard exists, if the electrical installations are defective or the insulation fails during operation.
- When switched-off the unit is not disconnected from mains. This is only the case when the mains plug is pulled.
- Any changes regarding the control elements of the unit can have an influence on the safe operation. All intended changes must be authorized by the manufacturer.
- After implementation of any change the operativeness of the safeguards must be verified.
- No unauthorized changes on the unit are allowed. All intended changes must be authorized by the manufacturer.

3.3.3 Environmental Issues

Environmentally conscious and anticipatory behaviour of staff avoids environmentally hazardous impacts.

The following principles apply for environmentally conscious behaviour:

- Environmentally hazardous substances must not get into the ground or in the drains. They should be kept in appropriate containers.
- Environmentally hazardous substances must be fed to utilization or disposal according to regional regulations.

When dealing with operating supplies always keep aware of the safety data sheet of the corresponding manufacturer.

3.3.4 Exclusion Criteria

PLEASE NOTE

Operating Staff

Staff is only allowed to operate the unit. They are neither allowed to open the unit chassis, remove parts, connect or disconnect power or coolant fluids nor to do maintenance.

3.4 Safety Equipment

PLEASE NOTE

The safety equipment listed below must be integrated in the local control environment by the customer, unless otherwise noted. These works must be carried out solely by trained experts. All required information can be taken from the wiring diagram shown in the addendum.

Safety equipment must not be modified, removed or taken out of operation. All parts of the safety equipment must be accessible at all times.

Familiarize yourself with all safety equipment. This can prevent or minimize bodily harm and/or unit failure in case of disaster.

3.4.1 Safety and Signalling Equipment included in the Unit

The unit is equipped with safety devices at critical spots (see Fig. 2).

- Water throughput is controlled by a flow switch that must be integrated in the potential-free safety circuit of the device to be cooled.
- The maximum temperature of the cooling circuit is controlled by a fixed thermostat with an opener contact that must be integrated into the safety circuit of the device to be cooled.
- The maximum pump pressure is limited by a safety valve that by-passes the liquid stream when the pressure pre-set is exceeded.
- The level of the cooling fluid container can be monitored against the state “empty”

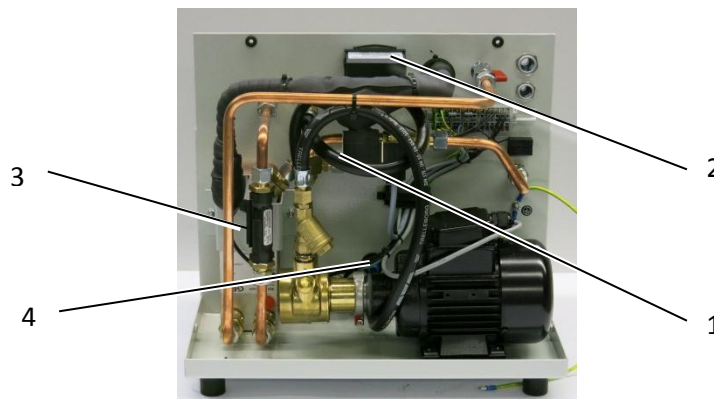

Fig. 3: Safety devices

1	Safety valve	2	Thermostat
3	Flow switch	4	Cooling container level sensor

3.4.2 Guards

Direct access to hazardous parts or areas of the unit is restricted by the unit cover. The cover may only be removed for the purpose of maintenance or repair works and shall be replaced prior to taking the unit back into operation. The unit cover is fixed by four M5 screws.

The electrical terminal area is accessible after removing the back cover. For opening/closing of the fasteners an AF8 wrench is required.

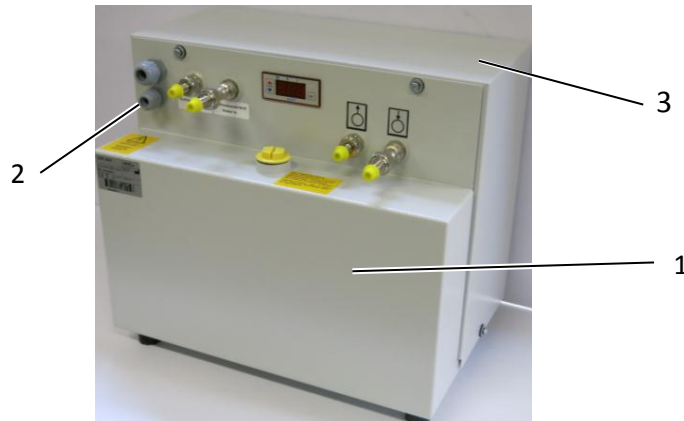

Fig. 4: Guards

1	Unit body	2	Access bushing for electric terminal block
3	Removable back cover		

3.4.3 Caution Labels

Danger spots on the unit are indicated in correspondence to German safety regulation BGV A8 "Sicherheits- und Gesundheitsschutzkennzeichnung am Arbeitsplatz".

Caution labels on the unit must be easily readable at all times. Illegible caution labels must be exchanged immediately.



Fig. 5: Caution labels on the unit

1	Hint on electrical hazardous area at the back of the unit body
---	--

3.5 In Case of Accidents

Should you or an other person be injured when working with the unit:

- Stay calm
- Render first aid
- Call the company first-aider without exception

4 Product Description

4.1 Intended Use

The water-water cooler WW 5001 is used for the cooling of a water circuit. As a coolant pure water or a water/antifreeze mixture may be used. The coolant circulates between the cooling unit and the device to be cooled. The cooling capacity depends on the temperature and flowrate of the cooling water (tap water). Its value is 3000 Watts at 5.0 l/min cooling water with 22°C.

The unit is exclusively intended for use in industrial and commercial environments. The intended use also includes the observance and following of all hints given in this Operation Manual.

4.2 Non-Conformity with the Intended Use

Operation of the unit under improper operational conditions is not allowed, as otherwise the safe operation can not be assured.

When using the unit in a way not compliant with the intended use, hazardous situations may occur.

Operation of the unit is not allowed under the following conditions:

- The unit is used for a purpose other than the one it is intended for.
- The unit or parts of it are damaged, the electrical installation is not correct or the insulation is broken.
- Protective or safety equipment is not functional or defect, improperly installed or missing.
- The unit is not working properly.
- The unit has been modified in any way.
- Controlling devices were modified in a way that is not permitted.
- Operational parameters were changed in a way that is not permitted.
- Operation in areas exposed to explosion hazards
- Operation with cooling media not according to specification
- Use of unauthorized tools
- Exceedance of the compulsory maintenance intervals

PLEASE NOTE

The manufacturer is not liable for damage occurring when using the unit in a way it was not intended for. When using the unit in a way it was not intended for, the manufacturer's warranty given by LAIRD will expire.

4.3 Unit Components

The unit consists of the following sub-assemblies .Additional information can be retrieved from the flow scheme shown in the addendum.

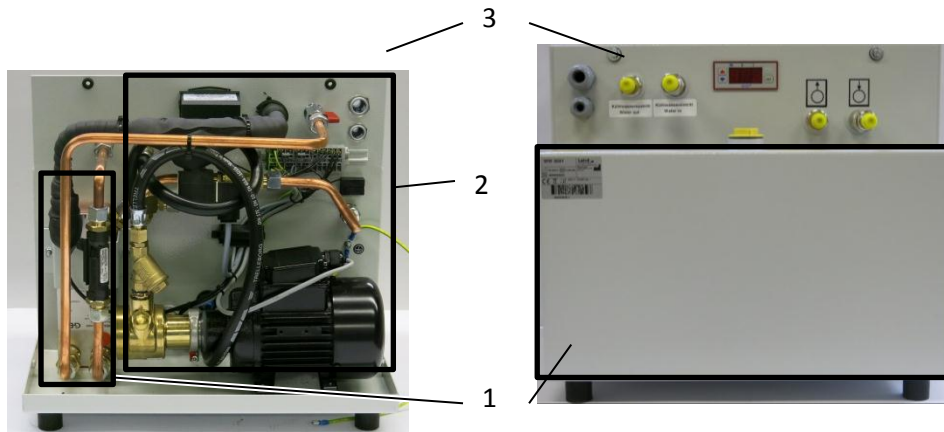

Fig. 6: Main components

1	Coolant container and plate heat exchanger	2	Cooling circuit
3	Body		

4.3.1 Functional principle

In the cooling circuit the coolant (water or water/glycol) is driven by the pump to the device that is to be cooled and back via the return flow. The heat is transferred to the cooling water through a plate heat exchanger following the principle of opposing flows. The heat is then dumped from the unit by the cooling water.

The coolant temperature is controlled by an electric thermostat, whereas coolant throughput is controlled by a flow control device. Both indications are made potential-free and must be integrated into the safety circuit of the device to be cooled.

4.4 Specifications

Dimensions and weight

Length:	450 mm
Width:	300 mm
Height:	370 mm
Weight:	24.0 kg (empty)
Coolant contents:	8.5 Liters

Table 4: *Dimensions and weight*

Performance data

Cooling capacity:	5000 W
Throughput:	> 10 lpm at 4.0 bars
Mains voltage:	230 VAC, 50/60 Hz
Current draw:	1.0 A
Operating noise:	≤ 48 dB (50 Hz) @ 1 m distance

Table 5: *Performance data*

Environmental conditions

Operating temperature:	+0°C ... +40°C
Storage temperature:	-20°C ... +70°C (empty)
Relative humidity:	10% ... 90%

Table 6: *Environmental conditions*

Settings

Maximum pressure	6.5 bars ± 0.2 bars
Flow switch off	4.0 lpm
Water supply temperature	25°C
Maximum temperature	35°C ± 3°C

Table 7: *Settings*

4.5 Setting-up Requirements

4.5.1 Installation Location

- The location must be even.
- When choosing the installation location the following must be kept in mind:
 - the air flow of the cooling air for the motor must not be restricted
 - forward and back flow connections must be easily accessible
 - all tubes must be installed without sharp bends

4.5.2 Environmental Conditions



CAUTION

Risk of damage due to unsuitable environmental conditions!

Damage to the unit and corrosion damage may result and are not covered by manufacturer's liability.

- The unit is only authorized for use in indoor environments.
- The unit must not be stored or operated in aggressive, humid environments.
- The unit must not be stored or operated outdoor.

Pay attention to the environmental conditions as given in the specifications on page 17.

4.5.3 Infrastructure

The following infrastructure is required for connecting the unit:

Parameter	Rated value
Operating voltage	230 VAC, 50/60Hz

Table 8: Required infrastructure

5 Transport

5.1 Safety Indications for Transportation and Setting-up

 **CAUTION****Risk of injury by lifting the unit!**

The weight of the unit is almost 24 kg (empty).

- Do not lift the unit manually!
- Always use proper auxiliary means such as a forklift or a jack lift!

 **CAUTION****Risk of damage by improper transportation!**

The attachments of different components inside the unit are not secured with transportation locks. In case of improper transportation these can be damaged without repair and would need to be replaced.

- Transport the unit in upright position!
- Do not tilt the unit or expose it to impacts!

5.2 Transportation of the Unit

The unit is delivered packaged and shrinked in foil on a transportable pallet. Leave the unit on the pallet until bringing it into service. Use a forklift or jack lift for transportation to the installation location.

5.3 Unpacking and Disposal of Packaging Material

Remove the foil before setting up the unit. Inspect the unit with regard to:

- Damage caused by transportation
- Completeness of delivery

Lift the unit with a forklift or jack lift off the transportable pallet. Dispose of the packaging material in accordance with regional regulations.

PLEASE NOTE

LAIRD advises to keep the transportable pallet and packaging material for later transportation of the unit.

6 Initial Operation

6.1 Safety Indications Related to Initial Operation

CAUTION

Danger of malfunction caused by faulty connections during initial operation!

Before switching on the unit make sure that:

- All safety equipment of the unit is implemented and functional.
- All connections were properly made.

Please follow the rules in chapter Safety Regulations on page 9.

6.2 Setting to Work

6.2.1 Placement

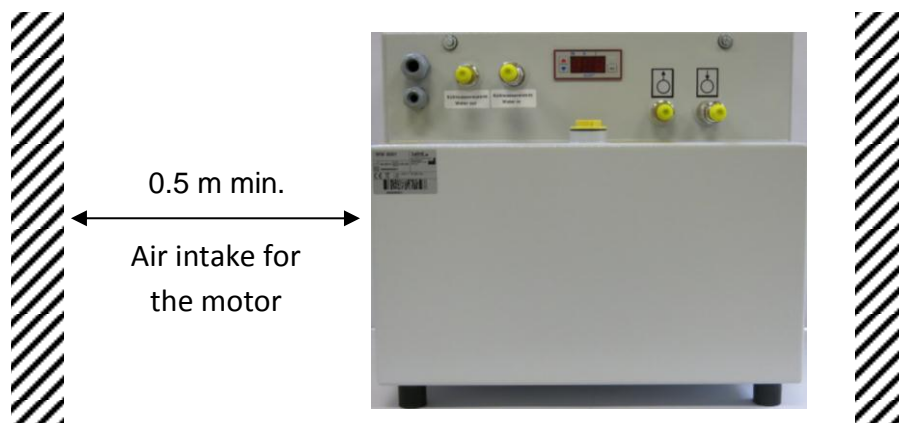

Fig. 7: Minimum clearance for air entrance and air exit

- 1) Move the unit to its installation location as mentioned in chapter 5.2.
- 2) Place the unit in a way that air entrance and air exit are not obstructed. Wall clearance on the left side (when facing the unit) must not be less than 0.5 m, otherwise operating capacity may be restricted.

PLEASE NOTE

In case of storage of the unit at temperatures lower than 5°C or higher than 40°C for longer periods please wait 3 hours prior to initial operation to allow for temperature adjustment.

6.2.2 Cooling Circuit Connection and Filling



CAUTION

Risk of damage by using improper cooling hoses!

This may lead to damage to persons, damage to the unit or corrosion damage!

- When choosing cooling hoses pay attention to sufficient burst strength and compatibility with coolant!
- Only use cooling hoses without any signs of damage!
- In case pure water is being used as coolant, ensure that non-transparent hoses are used to prevent the growth of algae in the water. Otherwise appropriate additives have to be used.

The cooling hoses with an internal diameter of 9 mm are connected to the unit by means of hose nipples. Water outlet and water inlet are indicated with respective symbols.



Fig. 8: Labelling of water inlet and water outlet

- 1) Connect a suitable hose to the hose nipples for cooling water inlet and cooling water outlet and secure it with a clamp, respectively.
- 2) Connect a suitable hose to the hose nipples for coolant inlet and coolant outlet and secure it with a clamp, respectively.
- 3) Connect the hoses to the corresponding nipples of the device to be cooled.

PLEASE NOTE

When connecting the cooling hoses pay attention to flow direction. Follow the documentation released by the manufacturer of the device to be cooled.

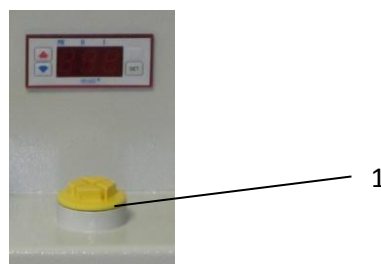

Fig. 9: Cap of coolant container

1	Cap (version for transport is shown)
---	--------------------------------------

- 4) Open the coolant container by removing the cap.
- 5) Fill the coolant container with about 8.5 liters of water or the water/antifreeze mixture.
- 6) Close the coolant container by fitting the cap. Make sure to use the red cap for operation mode.

6.2.3 Electrical Connections



DANGER

Danger to life through electrical shock when working on the electrical equipment of the unit!



- Switch off the unit before starting your work!
- Disconnect the unit from mains by pulling the mains plug!
- Verify that the installation is dead (volt-free)!
- Carry out earthing or short-circuiting!



CAUTION

Risk of damage through improper connections!

Improper integration of the unit into the safety circuit of the device to be cooled will lead to the inoperativeness of the safety equipment listed in chapter 3.4.1 on page 12.

- All connections required must be incorporated according to the wiring diagram shown in the addendum.
- Ensure yourself that all connected safety equipment is properly functioning.
- All works should be carried out by expert.

PLEASE NOTE

The unit is delivered without a mains cable. The electrical connection as well as the integration into the safety circuit of the device to be cooled are the customer's responsibility and must be accomplished by expert staff.

Information required can be taken from the specifications listed on page 17 and the wiring diagram in the addendum.

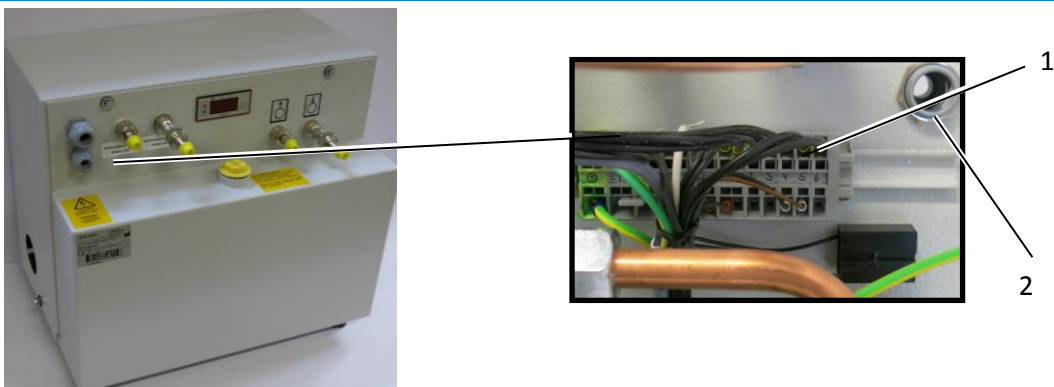

Fig. 10: Electrical terminal behind unit body

1	Electric terminal stripe	2	Cable bushings
---	--------------------------	---	----------------

- 1) Remove the back pannel after unscrewing the 4 screws.
- 2) Feed the mains cable through one of the cable bushings and make the connection to the terminal. Then do the same with the wires for the implementation of the safety circuit.
- 3) Remount the back panel.

After installation of the mains cable connect the unit to mains by inserting the mains plug or making a mains connection as required by the particular periphery.

6.2.4 Carrying out Setting to Work

After connecting the cooling circuit, filling the coolant container and finishing the electrical connections follow the steps below for the setting to work for the unit:

- 1) Remove the cap on the coolant container.
- 2) Switch on the unit and let it run for about 10 minutes in order to fill and vent the cooling circuit. Continously check the filling level during this procedure.



CAUTION

Lack of coolant may destroy the pump!

When looking into the filling plug of the coolant container the filling level must always be at least at 2/3 of the tank height.

- 3) If required, refill coolant.
- 4) Check the compliance with the operational parameters as specified on page 17.
- 5) Remount cap on coolant container.
- 6) Switch off the unit.

The unit is ready for operation.

6.3 Daily Start-up

Switch on the unit about 1 minute prior to using the device to be cooled.

6.4 Setting to work after Storage

Setting-to-work after storage will have to follow the same procedures as required for initial operation (see chapter 6.2).

7 Controlling the Unit

The unit is controlled using the controls of the equipment that is to be cooled.

All alarm and error signalling is only indicated on the control panel of the equipment that is to be cooled.

7.1 Safety Indications for Controlling the Unit

CAUTION



Lack of coolant may destroy the pump!

- Operate the unit only when the filling of coolant container is sufficient!
- Check the filling level of the coolant container regularly!

Also pay attention to the hints given in the chapter Safety indications from page 9 on.

7.2 Switching-on the Unit

- The unit is ready for switching-on.
 - 1) Switch on the unit about 1 minute prior to operation of the device to be cooled using the appropriate control of that device.
 - 2) Check the compliance with the operational data according to the specifications listed on page 17.

The unit is running.

7.3 Switching-off the Unit

- Cooling operation has come to an end
 - 1) Switch off the unit using the control of the device to be cooled.
 - 2) Close all valves that may exist in the extension of the hoses running to and from the unit.

The unit is out of operation.

7.4 Settings

PLEASE NOTE

The flow control device and the by-pass valve are set according to specification and sealed. Any modifications to these settings lie in the sole responsibility of the customer and must only be carried out by expert staff.

The adjustment of the flow control device should not be made without the help of proper measuring equipment, as the switching point must be set in a controlled way. Otherwise the function of the safety circuit might not be reliable and, as a result, the device to be cooled might get damaged.

7.4.1 Flow Control Device

The flow control device contains a closing contact whose OFF threshold is pre-set to a throughput of 4.0 liters per minute. For setting the switching point the switch head has to be adjusted. For that purpose the screw retained by red locking varnish must be released and the switching head must be moved while the throughput change is monitored by means of the equipment implemented for that purpose. After setting the switching point the head fixing screw must be firmly tightened again.

7.4.2 By-pass Valve

The by-pass valve is set by the manufacturer to a maximum pressure of 2.5 bars. If any modification to this setting should be required, please contact the LAIRD service department to receive briefing.

7.4.3 Temperature Controller

To change the temperature values of the water supply (temperature Max P0 or the alarm value (temperature P3) proceed as follows:

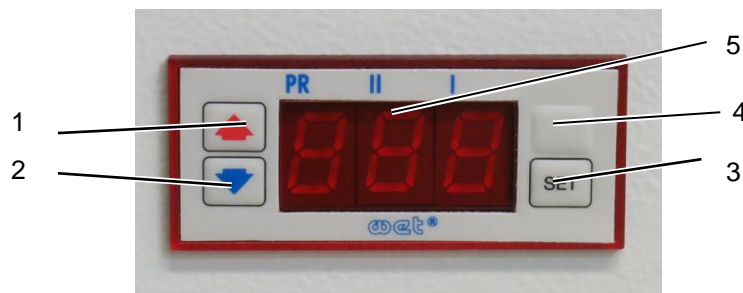

Fig. 11: Temperature controller with display

1	Control key UP	2	Control key DOWN
3	Control key SET	4	Control key NOT IN USE
5	3 digit display		

7.4.3.1 Water supply - nominal value (P0) set-up

- 1) Press the SET key for approx. 1 second.
 - ⇒ The display shows "P0".
- 2) Press the SET key to select P0.
 - ⇒ The current temperature setting (factory default value: 25 °C) is displayed. Set-up mode is activated.
- 3) Use the keys ▲ and ▼ to set the desired value.
- 4) Press the SET key.
 - ⇒ Set-up mode is now disabled. The new nominal value of the water supply temperature is set.
- 5) Controller will return to normal operating mode after about 5 seconds.
 - ⇒ New nominal value has been set.

7.4.3.2 Setting up the hysteresis of water supply nominal value (P1)

PLEASE NOTE

The hysteresis value of P1 is set as factory default to symmetrical 1°C. The value itself is stored in the internal parameter "P2" of the temperature controller.

- 1) Press the SET key for approx. 1 second.
 - ⇒ The display shows "P0".
- 2) Press the keys ▲ or ▼ until P1 is displayed.
 - ⇒ The display shows „P1“.
- 3) Press the SET key to select P1.
 - ⇒ The current temperature setting (factory default value: 1 °C) is displayed. Set-up mode is activated.
- 4) Use the keys ▲ and ▼ to set the desired value.
- 5) .Press the SET key.
 - ⇒ Set-up mode is now disabled. The display shows „P1“.
- 6) .Controller will return to normal operating mode after about 5 seconds.
 - ⇒ The new hysteresis value for P0 has been set.

7.4.3.3 Setting up the alarm value (P3) for maximum temperature

PLEASE NOTE

The maximum temperature alarm value is stored in the internal parameter „P3“ of the temperature controller.

A hysteresis represented by a symmetrical temperature value of 5°C around parameter “P3” has been set between flash-up of the alarm at exceedence of maximum temperature and ceasing of the alarm.

Example:

Value for “Water supply nominal” is set to 35°C.

Warning signal ON is triggered at 37.5°C.

Warning signal OFF is triggered at 32.5°C.

1) Press the SET key for approx. 1 second.

The display shows „P0“.

2) Use the key ▲ or ▼ until „P3“ is displayed.

⇒ The display shows „P3“.

3) Press the SET key to select P3.

⇒ The display shows the current value for P3 (factory default value: 35 °C). Set-up mode is activated.

4) Use the keys ▲ and ▼ to set the desired value.

5) Press the SET key.

⇒ Set-up mode is now disabled. The display shows „P3“.

6) Controller will return to normal operation mode after about 5 seconds.

⇒ The new alarm value for P0 has been set.

8 Disruptions

8.1 Safety Instructions in the Event of Malfunction

Adhere to the safety regulations detailed in chapter 3.

In the event of fault diagnostics follow the guidelines detailed below:

- Only sufficiently qualified personnel may perform maintenance on the unit.
- If you cannot determine the error, please contact LAIRD Services.

8.2 Disruption in Operation

The most common reason for disruption in operation of the unit is improper maintenance. Maintenance should be carried out regularly according to the maintenance intervals defined in chapter 9 on page 29.

In case of disruption start with checking the following:

- Coolant polluted?
- Low coolant contents because of leakage, evaporation or an extended cooling circuit with long hoses?

More help can be found in the following paragraph.

In case you do not succeed in identifying the problem cause by means of this manual please contact the service department of LAIRD.

8.2.1 Trouble Shooting

For trouble shooting you may rely on the following:

- Alarm signalling within the safety circuit of the device to be cooled
- Wiring diagram
- Flow scheme
- Trouble shooting table given below

Problem	Possible reasons	Countermeasure
The unit does not start.	Electrical connection not correct or no mains connection	Check connection, insert mains plug, check main power switch.
The unit is running but cooling capacity is not available or too low.	External hoses sharply bent?	Pay attention to smooth bends when hoses are connected.
	Unit properly located?	Clearance to wall not less than 0.5 m
	Is there flow in cooling circuit?	Flow is signalled potential-free by the safety equipment of the unit and can be visualized in the range of controls of the device to be cooled.
	Coolant in coolant container is low	Check coolant level, refill coolant if necessary. → page 23
	Fan turning?	Cover the ventilation grid next to the fan with a sheet of paper. If the paper is sucked and hold by the air flow, the fan works properly
	Ambient temperature too high?	Check specifications → page 17
Noisy unit	Coolant in coolant container is low	Refill coolant

Table 9: Trouble shooting list

9 Maintenance and Cleaning

Diligent maintenance is the prime factor for assuring an error-free and efficient operation of the unit. Operating personnel can perform these tasks when properly trained.

9.1 Maintenance Schedule

Device	Activity	Interval	Criteria	Tools	Performer
Coolant container	Check filling	Weekly	Coolant level min. at 2/3 of container	Visual inspection	Operating personnel
Strainer	Clean, replace if required	Every 3 months, more often when coolant polluted	Strainer undamaged and clean	Metric AF 24 wrench, cloth or vessel	Operating personnel

Table 10: Maintenance schedule

9.2 Refilling of Coolant

Since the cooling circuit is an open circuit, evaporation of coolant may occur. Thus, the filling level of the coolant container has to be checked regularly and coolant might have to be refilled as described on page 23.

9.3 Cleaning of Strainer

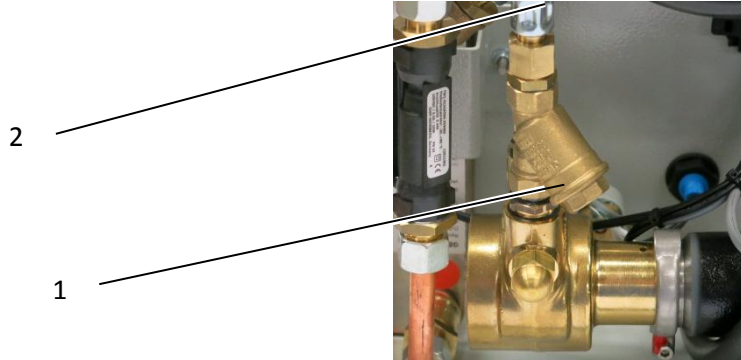

Fig. 12: Locations of coolant supply line and strainer

1	Strainer cover	2	Coolant supply line
---	----------------	---	---------------------

- 1) Disconnect the unit from mains.
- 2) Remove the back panel.



CAUTION

Some amount of coolant will leak from the strainer.

It is suggest you put sufficient amount of cloth in a circle underneath the stainer cap location.

- 3) Remove the strainer cover.
- 4) Take off the strainer and clean it. In case of damage the strainer must be replaced.
- 5) Remount the strainer and screw on the cover.
- 6) Should any coolant leak from the strainer the cap must be screwed on using a little more force.
- 7) Remount the back panel.
- 8) Start-up the unit for venting the cooling circuit (s. page 23).
- 9) Check the coolant level and refill if required.

9.4 Cleaning of Unit Body

CAUTION

Risk of damage through use of improper cleansing material!

When using aggressive or abrasive cleaning agents corrosion damage may occur as result of a damaged paint film.

- For cleaning the unit body only use mild cleaning agents (e.g. dish washing detergents).
- Use clean and lintless cloth for cleaning.

Regularly remove dirt from the casing of the unit to prevent corrosion damage and clogging of the air grid. Pay attention that all the plates at the unit are always clean and legible.

10 Repair

10.1 Safety Instructions on Repair

Ensure to adhere to safety regulations as detailed from page 9 on.

10.2 Repair Procedures

In case of malfunctioning during the warranty period the unit must be sent to the LAIRD service department for repair (see page 7). When warranty has expired, no restrictions from the side of LAIRD exist with respect to repair work carried out by the customer as long as guarantee and warranty conditions remain untouched. In any case only expert staff is authorized for doing repair work.

PLEASE NOTE

When doing repair work on the unit always be aware of the safety regulations as defined in chapter 3.

11 Dismounting, Disposal, Storage

11.1 Temporary Placing out of Operation

To take the unit out of operation mode for maintenance, repair or process interruptions proceed as follows:

- Cooling operation is finished.
- 1) Disconnect the unit from mains.
- 2) Remove all cabling from the unit.
- 3) Remove all hoses to and from the unit.

PLEASE NOTE
In case the coolant contains glycol, it must be collected and disposed according to current regulations.

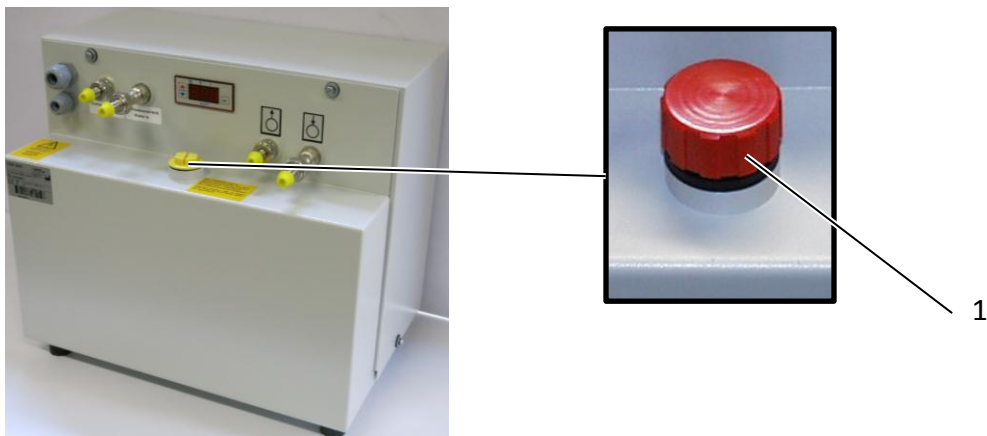

Fig. 13: Drain with operation cap

1	Operation cap
---	---------------

- 4) Two persons shall lift the unit up and turn it over.
- 5) Let the coolant container run empty into an appropriate vessel.
- 6) Clean the unit.

The unit is placed out of operation.

11.2 Re-packaging of the unit

- The unit has been emptied (see chapter 11.1).
- 1) Lift the unit with a forklift or jacklift and place a transportable pallet under it.
- 2) Wrap the main power cord into a circle and attach it securely to the unit's top frame with duct tape.
- 3) Package the unit including the transportable pallet with shrinking foil and shrink the foil tight.
- The unit is ready for transportation.

11.3 Storing the Unit

The storage area must be even and the unit should not stand on an edge or other obstructive object.

The environmental conditions for storage of the unit or parts of it can be found in the specification paragraph on page 17.

11.4 Disposal

The unit was manufactured mainly from recycable material.

Make sure the components of the unit end up at a qualified company for disposal and recycling.

Contact LAIRD for taking back end-of-life units (see company contact on page 7 or ask a company specialized in disposal and recycling).

11.5 Disposal of Operating Materials

The operating materials of the unit can be hazardous to the environment and to health.

- Make sure the operating materials are disposed of or recycled according to local regulations.
- Also, the safety specifications of the coolant manufacturer must be obeyed.

11.6 Return of the unit to LAIRD

PLEASE NOTE

Declaration of decontamination

Before re-shipment of the unit a declaration of decontamination must be sent to LAIRD.

12 Wear Parts and Spare Parts

12.1 General Information

Spare parts must comply with the technical specifications defined by LAIRD. Original LAIRD parts are subject to strict obligations and fulfill these requirements.

LAIRD does not provide warranty service in case of damages caused by the use of spare parts made by manufacturers other than LAIRD.

PLEASE NOTE

Identification data concerning the unit and spare parts

The type of unit and the article number can be found on the identification plate of the unit. The corresponding numbers in Fig. 12 as well as the part descriptions are listed in the spare part list.

Please direct your inquiries and orders to LAIRD (contact see page 7) with the following detailed information:

- Type of unit
- Article number
- Serial number
- Part description
- Quantity
- Shipping details

12.2 Parts Overview

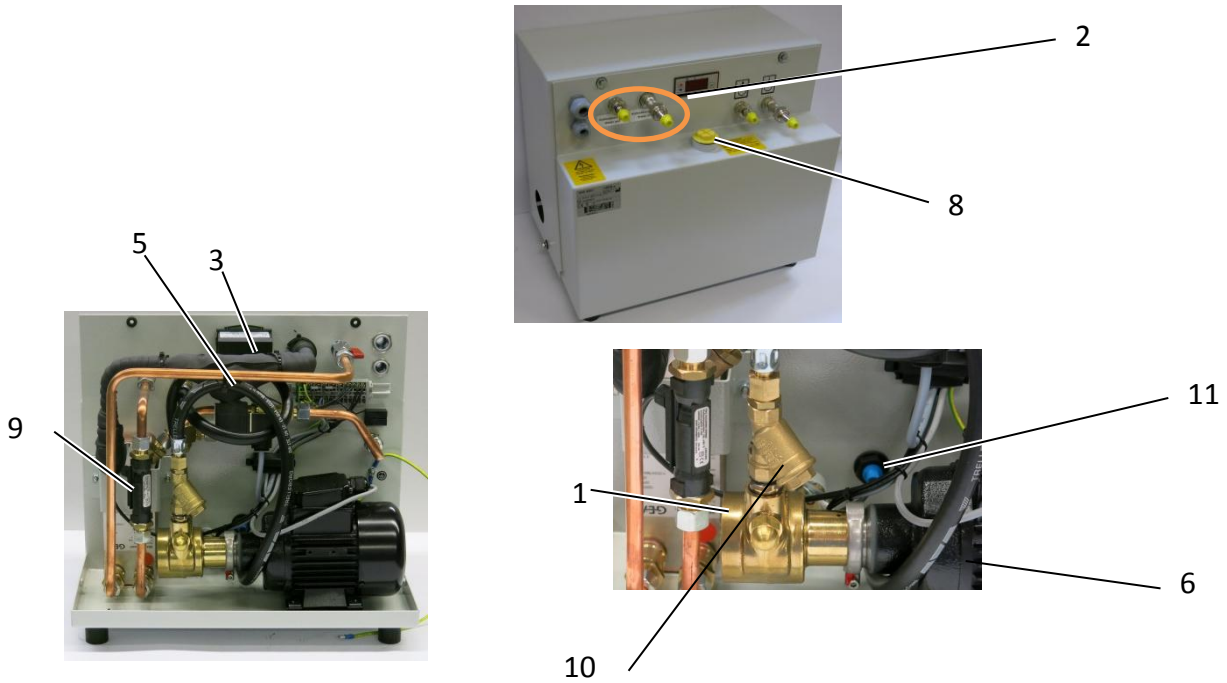

Fig. 14: Spare parts overview

Pos.	Qty	Description	Article No.
1	1	Pump	110919.70
2	1	Hose fittings (3 parts)	91725013.00
3	1	Temperature controller	95160049.00
4	1	Temperature sensor (not shown)	95160050.00
5	1	Magnet valve	95200102.00
6	1	Motor 230VAC, 50/60Hz	95205201.00
7	1	Toothed ring for coupling of pump to motor (not shown)	95205203.00
8	1	Red operation cap (yellow transport cap shown)	95288005.00
9	1	Flow switch	95140538.01
10	1	Strainer	96299041.00
11	1	Level sensor RW16	95240301.00

Table 11: Spare parts

Addendum

Flow scheme

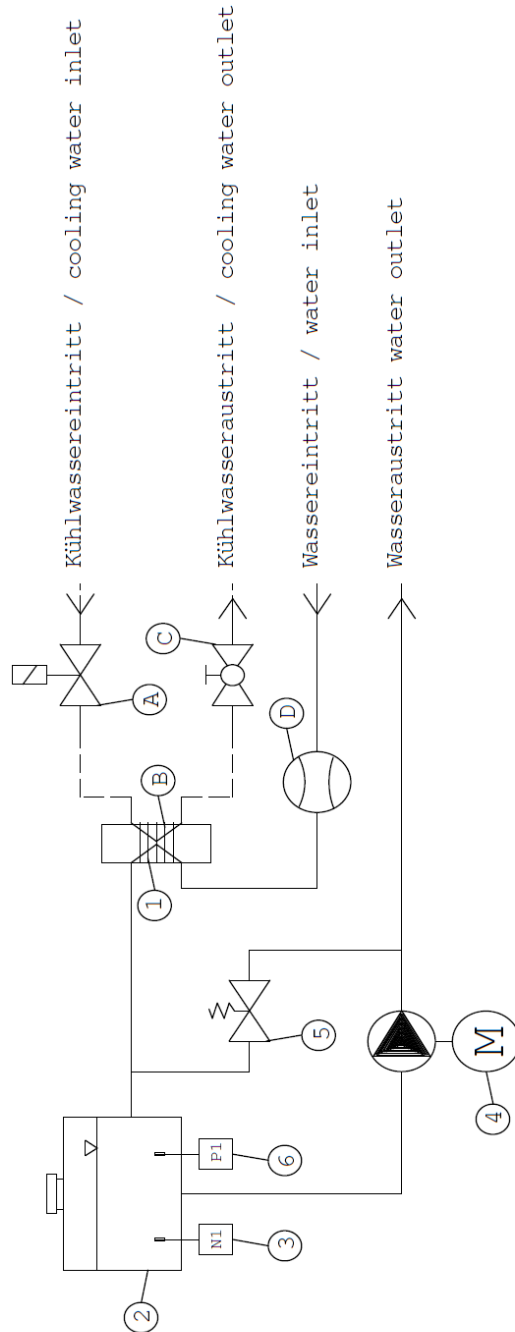

- | | |
|---|---|
| Wasserkreislauf / water circuit | Kühlwasserkreislauf / cooling water circuit |
| 1=B Plattenwärmetauscher / evaporator | A Magnetventil / solenoid valve |
| 2 Tank / reservoir | B=1 Plattenwärmetauscher / evaporator |
| 3 Temperaturregler / temperature controller | C Kugelhahn / ball cock |
| 4 Pumpe mit Motor / pump with motor | D Strömungswächter / flow switch |
| 5 Überströmventil / bypass valve | |
| 6 Niveauewächter / level sensor | |

Wiring diagram

