

READ ALL INSTRUCTIONS COMPLETELY BEFORE PROCEEDING

COMPONENT IDENTIFICATION

CONNECTOR ASSEMBLY

Jacketed Boots Available Separately

3.0mm Boot
FMCBT3AQ-X
FMCBT3BL-X
FSCBT3BU-X

1.6 / 2.0mm Boot
FMCBT2AQ-X
FMCBT2BL-X
FSCBT2BU-X

Connector	Outer Hsg. Color	Backbone Color	Boot Color
10 Gig 50µm	Black	Aqua	Aqua
50µm	Black	Black	Black
62.5µm	Elec. Ivory	Elec. Ivory	Black
Singlemode	Blue	Blue	Blue

ITEMS REQUIRED FOR TERMINATION

ITEM	PART NUMBER	DESCRIPTION
1	OCTT	OptiCam Termination Tool
2	FSCC	SC Cradle for OptiCam Termination Tool (OCTT)
3	FVFLPC-2.5SMY	2.5mm Universal Patch Cord for OptiCam Termination Tool (OCTT)
4	CST-115	Fiber Cable Jacket Stripper
5	FALC	Alcohol Bottle (empty)
6	FBFSP	Fiber Buffer Stripper
7	FJQCVR	Fiber Cleaver Tool
8	FGLS	Safety Glasses
9	FKS	Fiber Kevlar Shears
10	FSTY	Fiber Safety Tab Stickers for fiber scraps
11	FSWB-C	Cleaning Swabs
12	FWP-C	Lint-Free Wipes
13	PFX-0	Fine-Tip Marking Pen
14	--	Isopropyl Alcohol (Reagent Grade, 90% minimum concentration; not available from Panduit)
OPTIONAL	FS116*	SC OptiCam Connector Stripping Template
OPTIONAL	FJQCVRB	Replacement Blade for Fiber Cleaver

TABLE OF CONTENTS

	Page(s)
Safety Precautions and OptiCam Termination Tool Patch Cord Maintenance.....	2
250µm Loose Tube Fiber Termination and Fan-out Kit Termination Instructions.....	3
Instructions for Terminating Panduit OptiCam Connectors using OptiCam Fanout Kit.....	4
900µm Tight-Buffered Fiber Termination Instructions.....	5-8
Jacketed Cable Termination Instructions.....	9-12

For Technical Support: www.panduit.com/resources/install_maintain.asp

* Denotes revision letter.

SAFETY PRECAUTIONS

1. SAFETY GLASSES

WARNING: IT IS STRONGLY RECOMMENDED THAT SAFETY GLASSES BE WORN WHEN HANDLING BARE OPTICAL FIBER. THE BARE FIBER IS VERY SHARP AND CAN EASILY DAMAGE THE EYE.

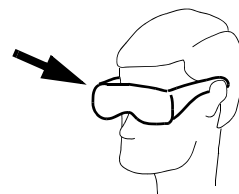

2. ISOPROPYL ALCOHOL

WARNING: ISOPROPYL ALCOHOL IS FLAMMABLE. CONTACT WITH THE ALCOHOL CAN CAUSE IRRITATION TO THE EYES. IN CASE OF CONTACT WITH THE EYES, FLUSH WITH WATER FOR AT LEAST 15 MINUTES. ALWAYS USE ISOPROPYL ALCOHOL WITH PROPER LEVELS OF VENTILATION. IN CASE OF INGESTION, CONSULT A PHYSICIAN IMMEDIATELY.

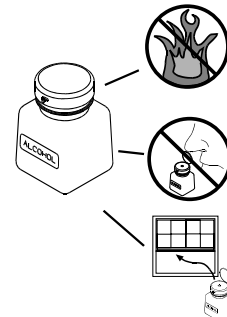

3. DISPOSAL OF BARE FIBERS

WARNING: PICK UP AND DISCARD ALL PIECES OF BARE FIBER WITH STICKY TABS. DO NOT LET CUT PIECES OF FIBER STICK TO CLOTHING OR DROP IN THE WORK AREA WHERE THEY ARE HARD TO SEE AND CAN CAUSE INJURY.

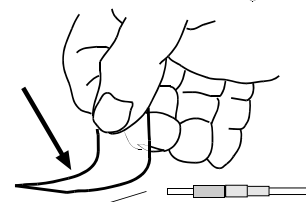

4. LASER LIGHT PROTECTION

DO NOT VIEW DIRECTLY WITH OPTICAL INSTRUMENTS. CLASS 1M LASER PRODUCT. VIEWING THE LASER OUTPUT WITH CERTAIN OPTICAL INSTRUMENTS (FOR EXAMPLE, EYE LOUPES, MAGNIFIERS, AND MICROSCOPES) WITHIN A DISTANCE OF 100 MM MAY POSE AN EYE HAZARD.

CAUTION: USE OF CONTROLS OR ADJUSTMENTS OR PERFORMANCE OF PROCEDURES OTHER THAN THOSE SPECIFIED HEREIN MAY RESULT IN HAZARDOUS RADIATION EXPOSURE.

- NEVER POINT THE LASER INTO THE EYES OF OTHERS.
- DO NOT STARE DIRECTLY AT THE LASER BEAM.
- DO NOT SET UP TOOL TO WORK AT EYE LEVEL OR OPERATE THE TOOL ON A REFLECTIVE SURFACE AS THE LASER COULD BE PROJECTED INTO YOUR EYES OR THE EYES OF OTHERS.

ALWAYS TURN THE LASER OFF WHEN IT IS NOT IN USE OR IS LEFT UNATTENDED FOR A PERIOD OF TIME. REMOVE THE BATTERIES WHEN STORING FOR AN EXTENDED PERIOD OF TIME TO AVOID DAMAGE TO THE TOOL SHOULD THE BATTERIES DETERIORATE.

5. CABLE HANDLING

WARNING: FIBER OPTIC CABLE CAN BE DAMAGED BY EXCESSIVE PULLING, TWISTING, CRUSHING OR BENDING STRESSES. CONSULT THE APPROPRIATE SPECIFICATION SHEETS AS PROVIDED BY YOUR CABLE VENDOR. ANY DAMAGE MAY DECREASE OPTICAL PERFORMANCE.

Complies with FDA performance standards for laser products except for deviations pursuant to Laser Notice No. 50, dated June 24, 2007.

Complies with IEC 60825-1 Ed. 2 (2007)



OptiCam Termination Tool Patch Cord Maintenance

Clean both ends of the FVFLPC-2.5SMY after 50 matings or sooner if performance diminishes.

1. Clean ST connector ferrule endface with a lint-free wipe (FWP-C) soaked with alcohol (reagent grade isopropyl alcohol, with a minimum 90% concentration).
2. Clean Ferrule Adapter end by unscrewing housing and removing split sleeve. Clean the ferrule endface with an alcohol soaked lint-free wipe. Refer to Visual Inspection and Cleaning of Fiber Optic Components Best Practices document FS061* at www.panduit.com. Make sure that the split sleeve is clean. Replace the split sleeve onto ferrule and screw housing into place securely.

NOTE: Replace the split sleeves if the FVFLPC-2.5SMY continues to have diminished performance after three cleanings. Additional split sleeves for the FVFLPC-2.5SMY are located in the FVFLPC-2.5SMY package.

For Technical Support: www.panduit.com/resources/install_maintain.asp

Instructions For Terminating Panduit Fiber Optic Connectors onto 250 Micron Coated Fiber

Part Number: F250BT-C

When terminating any Panduit fiber optic connector onto 250µm coated fiber, follow the 900µm Tight-Buffered Termination procedure in the appropriate connector installation instructions with the following modifications:

OptiCam Connectors Refer to Stripping Template FS115* for LC and FS116* for SC and ST

1. After placing the 900µm boot onto the 250µm fiber, place one build-up tube (F250BT) onto the fiber and slide it back out of the way.
2. Place an insertion mark on the build-up tube 15mm for LC and 11mm for SC or ST from the end of the tube closest to the end of the fiber.
3. Use the buffer stripper to strip at least 30mm of coating and wipe the bare fiber clean with an alcohol soaked wipe.
4. Place an insertion mark on the coated fiber 15mm for LC and 11mm for SC or ST from the end of the stripped coating.
5. Cleave the fiber 7mm from the end of the coating and slide up the build-up tube so that the end is even with the cleaved fiber end.
6. While holding the fiber and build-up tube together behind the build-up tube, insert them into the back of the connector until the build-up tube bottoms out within the connector. The insertion mark on the build-up tube should be hidden within the back of the connector.
7. Now slide just the fiber forward using constant light pressure until it bottoms out within the connector on the fiber stub. The insertion mark should be visible through the build-up tube and located near the back end of the connector.
8. Squeeze both clamp arms to open the clamp pads. Place the fiber between the open clamp pads and release the clamp arms while creating a slight bow in the fiber. The bow is intended to provide appropriate glass-to-glass mating pressure. **DO NOT** shuttle the cradle forward, as this may create an excessive bow behind the build-up tube.
9. Turn on the laser and complete the connector termination as described in the appropriate instruction sheet.

* Denotes revision letter.

Instructions For Terminating Panduit OptiCam Connectors using OptiCom Fanout Kit

INDOOR PREMISE APPLICATION

Fanout Kit Part Numbers: FO6CB, FO12CB

IMPORTANT! TURN OFF “FIT TO PAGE” WHEN PRINTING

1. Install the Fanout Kit according to the installation instructions FS047*.
2. Feed the 250 μ m coated fibers through the 900 μ m fanout tubing until at least 30mm of fiber protrudes from the end of the tubing. Trim the coated fibers to length at 30mm.
3. To reduce the amount of fiber movement, place a drop of adhesive (Loctite 401 or equivalent Cyanoacrylate adhesive) at the point that the coated fibers exit the 3mm cable jacket.

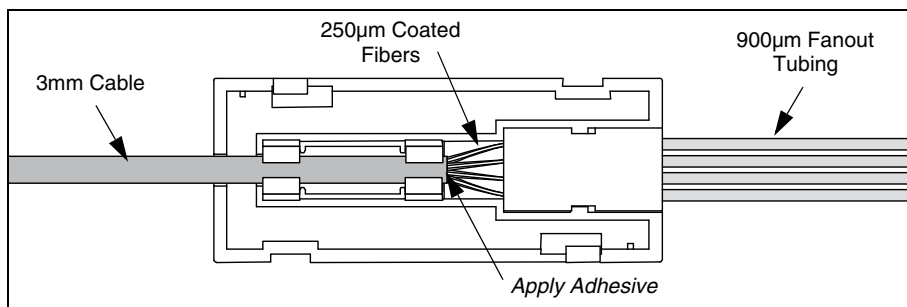

4. Place the 900 μ m boots onto the fanout tubing and slide them back out of the way.
5. Place an insertion mark on the fanout tubing, 15mm for LC and 11mm for SC or ST, back from the end of the tubing.

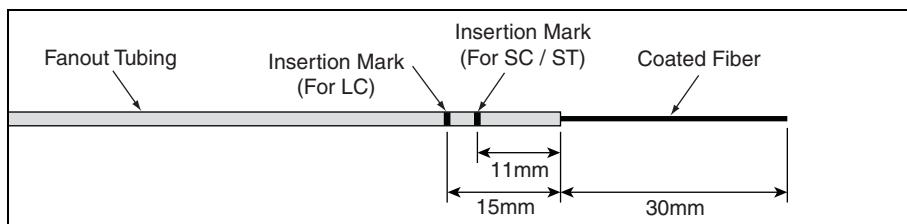

6. Place a coating removal mark on the coated fiber 3mm from the end of the fanout tubing. Strip the coating up to the coating removal mark. Note: The 3mm of coating extending from the end of the tubing is intended to compensate for fiber movement within the fanout tubing during termination.

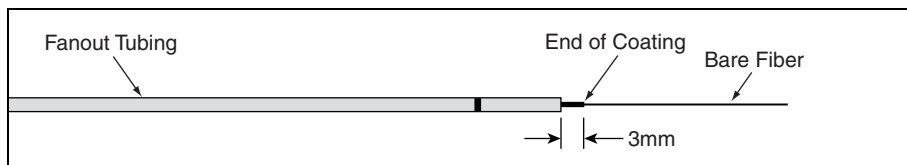

7. Clean the bare fiber using an alcohol soaked lint-free wipe to ensure the fiber is free of all debris.
8. Cleave the fiber 7mm from the end of the fiber coating. Note: Cleave length from end of tubing is approx. 10mm.

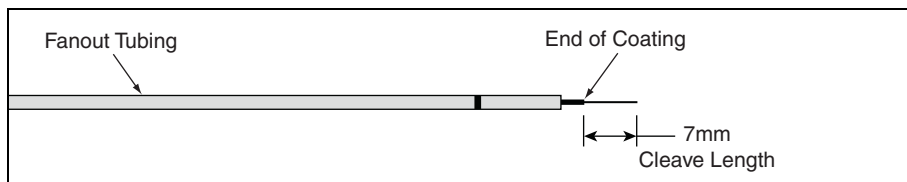

9. With the connector mounted in the OptiCam termination tool, insert the cleaved fiber into the connector using constant light pressure until the fiber bottoms out on the fiber stub within the connector. The insertion mark on the fanout tubing should be in close proximity to the back of the connector.
10. Squeeze both clamp arms to open the clamp pads of the OptiCam termination tool. Place the fanout tubing between the open clamp pads and release the clamp arms. Slide the cradle holder towards the cable to create a bow in the fiber providing appropriate glass-to-glass mating pressure. Cam the connector to secure the fiber.
11. Turn on the laser and complete the termination as described in the appropriate OptiCam instruction sheet.

* Denotes revision letter.

For Technical Support: www.panduit.com/resources/install_maintain.asp

900 μ m Tight-Buffered Fiber Termination

Note: When using OptiCam 2 termination tool, refer to FS132 Quick Setup Guide on how to use tool.

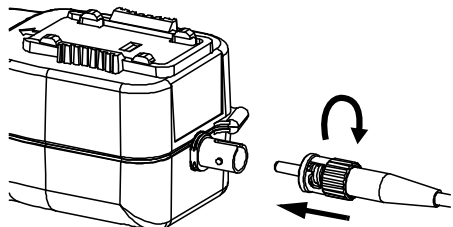
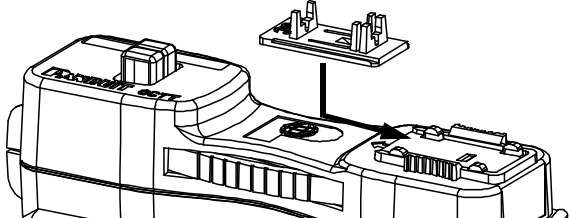
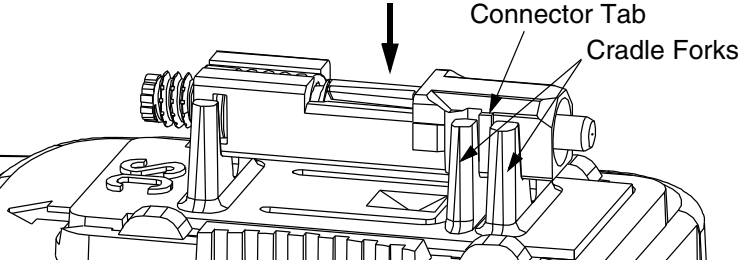
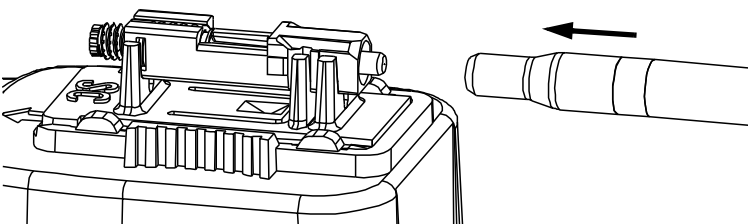
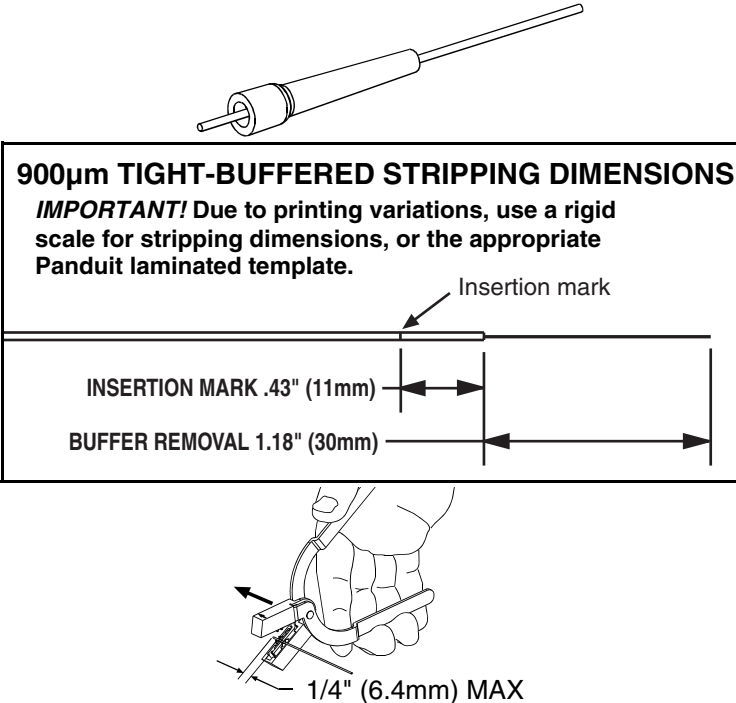
<p>1. Attach Patch Cord to OCTT</p> <p>Make sure laser switch is in the "O" (OFF) position. Remove protective dust cover from laser. Insert ST end of FVFLPC-2.5SMY patch cord into laser aperture making sure to align tabs. Rotate barrel of ST connector clockwise to lock in place.</p>	
<p>2. Insert Connector Cradle</p> <p>Align SC Cradle with OCTT cradle holder and slide cradle under tabs of cradle holder until it stops. Grip cradle holder by grip pads and slide cradle holder to the pre-termination position (towards the laser aperture).</p>	
<p>3. Insert Connector into Cradle</p> <p>Remove both dust caps from the connector inner housing assembly. Place the inner housing assembly into the SC cradle so that the tabs on the connector housing are between the cradle forks.</p>	
<p>4. Attach Patch Cord to Connector Ferrule</p> <p>Note: During insertion, the ferrule adapter end must be in-line with the connector ferrule, NOT at an angle. While holding the connector still, gently slide the ferrule adapter end over the connector ferrule until it stops. To maximize VFL patch cord life, avoid side-loading the ferrule adapter end during insertion and testing.</p>	
<p>5. Strip 900μm Tight-Buffered Fiber</p> <p>5.1 Insert the fiber end through the small end of the 900μm boot. Slide the boot back out of the way.</p> <p>5.2 Use buffer stripper to strip at least 1.18" (30mm) of buffer.</p> <p>5.3 Use the marking pen to place an insertion mark 0.43" (11mm) back from the end of the stripped buffer.</p> <p>Buffer Stripping Guidelines</p> <ul style="list-style-type: none"> Remove no more than 1/4" (6mm) of buffer at a time to avoid breaking the fiber. Refer to cable manufacturer's buffer stripping guidelines for specific recommendations. Hold the buffer stripper such that the arrow on the tool points in the direction of buffer removal. Position the fiber in the tool's V-notches. Squeeze the handles firmly and pull tool in the direction of the arrow on the tool. Clean the buffer stripper blades after each strip by holding the handles open then pulling the casings back and letting them snap back against the blades. 	

For Technical Support: www.panduit.com/resources/install_maintain.asp

6. Cleave 900µm Tight-Buffered Fiber

- 6.1 Remove and dispose of any remaining fiber scraps in the cleaving tool.
- 6.2 Clean bare fiber using an isopropyl alcohol (90% minimum concentration) soaked lint-free wipe. The fiber should be free of all coating and residue. To prevent contamination, do not set fiber down or allow it to touch anything after cleaning.
- 6.3 Depress the fiber clamp lever and insert the end of the fiber under the fiber clamp and in the V-groove. Hold the cleaving tool in your hand and depress the fiber clamp lever to raise the fiber clamp. Insert the end of the fiber into the V-groove and under the fiber clamp. Release the fiber clamp lever when the end of the buffer is located at the 7mm mark ($\pm 0.5\text{mm}$).
- 6.4 **This is a critical step for successful termination.** Gently hold the buffered fiber against the groove in the base plate using thumb and forefinger of your free hand. With your other thumb, **gently** push down on the housing until the ceramic blade contacts the fiber and the end of the housing contacts the rubber coating on the base plate. **DO NOT** cut the fiber with the ceramic blade. Release the housing so that the blade is no longer contacting the fiber.
- 6.5 Hold the tool in one hand while still holding the fiber against the base plate. Bend the base plate down until the fiber breaks. To prevent contamination, do not set fiber down or allow it to touch anything after cleaving. **IMPORTANT:** Do not clean fiber after cleaving. Replace the ceramic blade in the cleaving tool after every 1000 cleaves, or if installation yield decreases.
- 6.6 Replacement blade (FJQCVRB) is available.

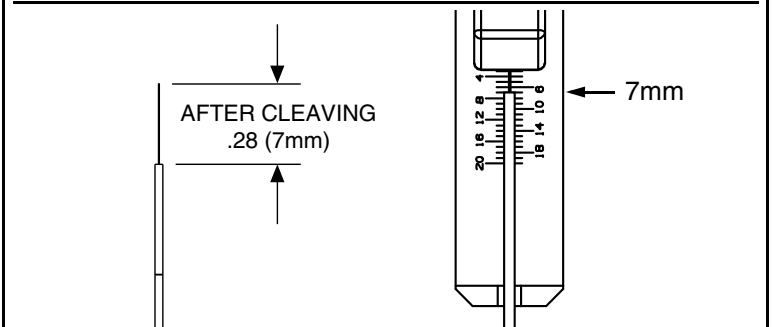
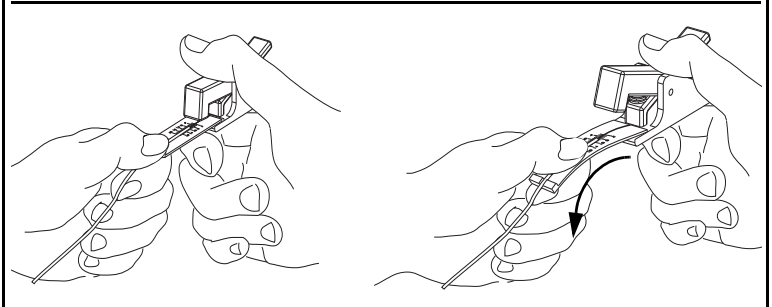
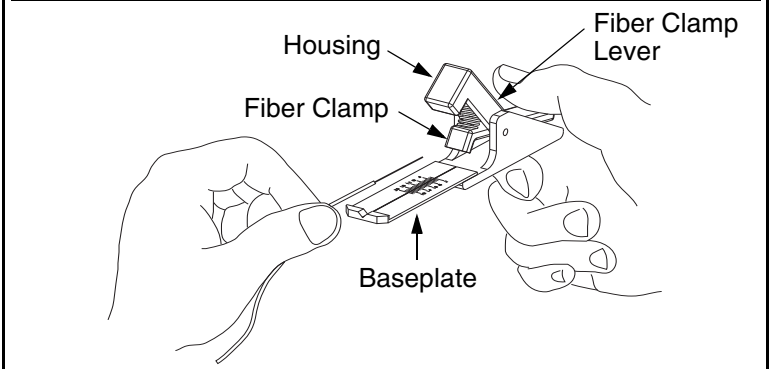
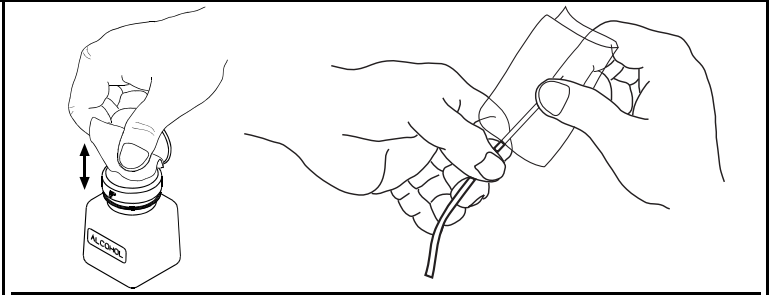

7. Insert Fiber

Insert fiber into the connector body using constant light pressure until it stops on the fiber stub. Excessive force during insertion may break the fiber. The fiber should be guided in straight, not at an angle. If resistance is felt before the insertion mark is in close proximity to the back of the connector then retract the fiber a small amount and continue inserting. If the fiber insertion mark is not in close proximity to the back of the connector then withdraw the fiber completely out of the connector. Inspect fiber cleave length. If the fiber cleave length is less than 7mm then discard the connector and return to step 5. If the fiber cleave length is 7mm then slightly rotate the fiber before repeating this step.

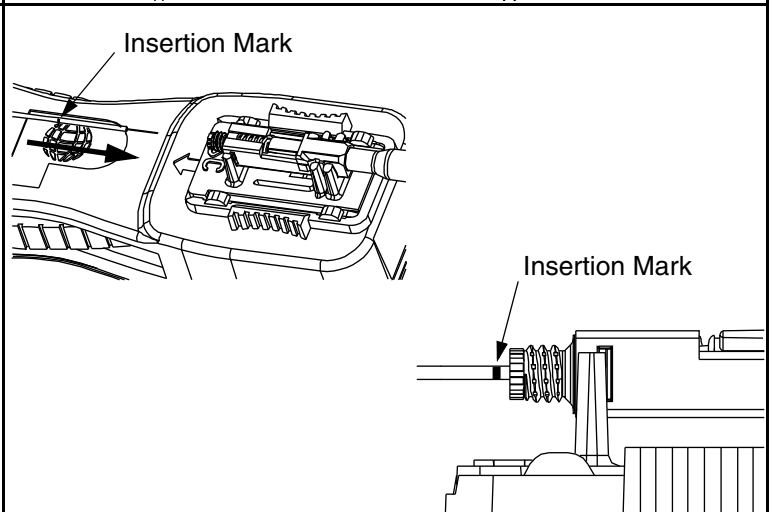

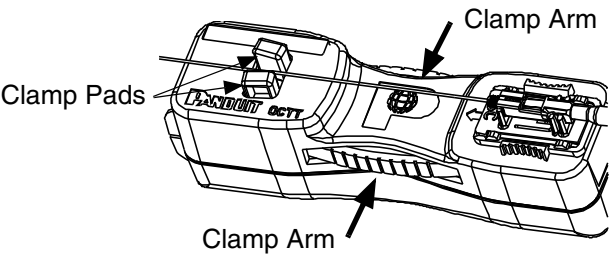
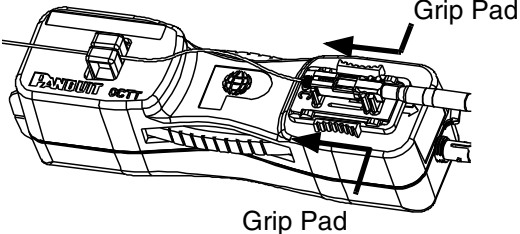
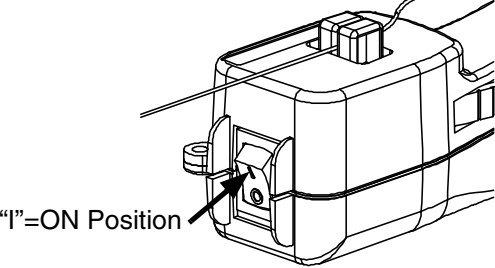
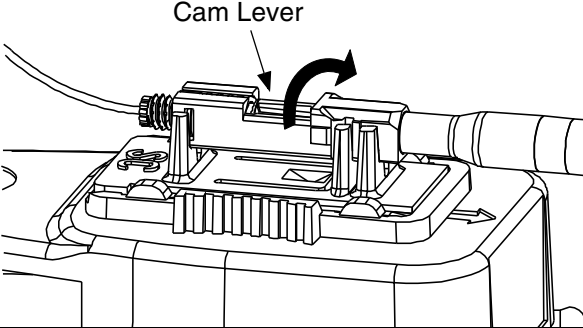
<p>8. Clamp Cable Squeeze both clamp arms to open clamp pads. Place cable between the clamp pads and release clamp arms. The fiber should be straight and the insertion mark should still be in close proximity to the back of the connector.</p>	
<p>9. Shuttle Cradle Holder Grip cradle holder by grip pads and slide cradle holder towards the cable until it stops. This will create a bow in the fiber.</p>	
<p>10. Turn On Laser On the end of the OCTT tool, toggle the switch to the "I" (ON) position. If the fiber is in the correct position after this step, a multimode connector typically will either be dark or glow very dimly; a singlemode connector will typically glow moderately.</p>	
<p>11. Cam the Connector Rotate the cam lever 90° counterclockwise until it stops (when looking from rear of connector). The glow coming from the connector cam region should dim or remain dark. If not, turn the laser off and un-cam the connector. Pull the fiber back slightly and then gently urge it forward until it stops on the stub fiber. (Re-check to make sure the insertion mark is near the back of the connector.) Turn the laser on and re-cam the connector, it should dim or remain dark. If not, turn off the laser and repeat the process starting at step 5.</p>	
<p>12. Turn Off Laser Toggle the OCTT switch to the "O" (OFF) position. While holding connector in place, remove ferrule adapter end of patch cord from connector.</p>	
<p>13. Place the Dust Cover on the Patch Cord (Optional)</p>	
<p>14. Unclamp Cable Squeeze both clamp arms to open the clamp pads. Remove cable from between the clamp pads and release clamp arms. CAUTION: DO NOT pull on cable while the connector is still held in place by the cradle. Doing so could break the fiber or create an unacceptable termination.</p>	
<p>15. Remove Connector from Cradle Remove the connector from the cradle by lifting straight up.</p>	
<p>16. Reposition Cradle Holder Grip cradle holder by grip pads and slide cradle holder back to the pre-termination position (towards the laser aperture).</p>	
<p>17. Remove Fiber from Cleaver Tool Depress the fiber clamp lever then remove and properly dispose of the fiber scrap.</p>	

18. Assemble Connector and Boot

- 18.1 Push the boot forward onto the grooved area of the backbone until it is against the flange.
- 18.2 Align the external chamfers on the front of the inner housing assembly with the internal chamfers at the front of the outer housing.
- 18.3 Push the inner housing assembly into the outer housing until it snaps into place. Once in place the outer housing should be able to move freely back and forth over the inner housing and boot. Clean the ferrule end face with an alcohol soaked wipe, and then a dry wipe. Place dust cap over the ferrule end.

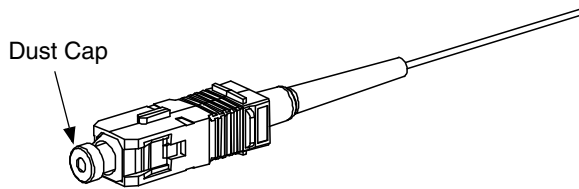
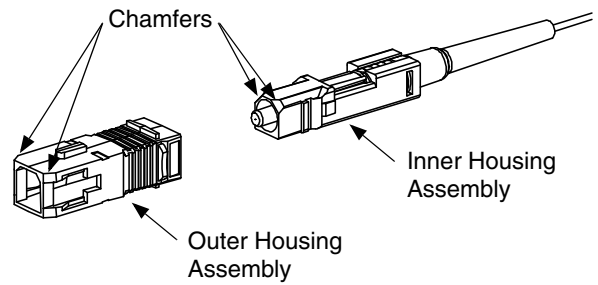
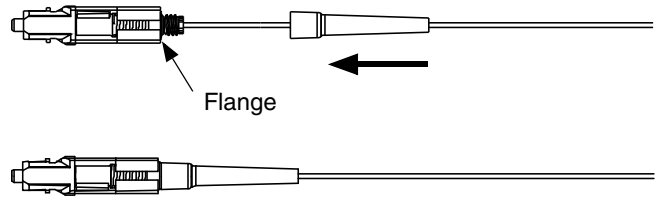

19. Attach Duplex Clip (Optional)

- 19.1 Orient the connector as shown with the connector key facing upward in the same direction as the 'A', 'B' and 'KEY' markings on the duplex clip. Insert the connector into one side of the clip on a slight angle and rotate into place. The upper and lower legs of the clip slide over the connector and "snap" when the connector is in place. The connector is fully seated once the top and bottom connector flanges are inside of the rectangular slots in the clip.
- 19.2 Repeat this procedure for the other connector, completing the duplexing step.

Note: When making cable assemblies, be sure to follow the correct 'A->B' polarity cross-over between connectors.

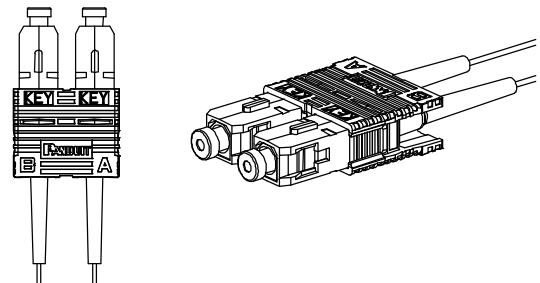
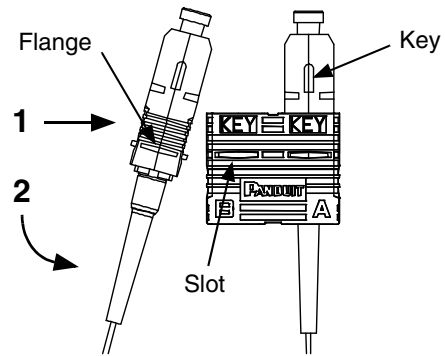

20. Re-Termination

The connector can be re-terminated if needed. Make sure that the dust cap is on the ferrule. Grip the outer housing and push tip of connector down onto a hard surface. The inner housing will release from the outer housing. Remove outer housing. Slide the boot off the backbone. Un-cam the connector and remove the fiber. Repeat from step 1.

CAUTION: DO NOT push down without a dust cap installed on the ferrule. Doing so could damage the pre-polished fiber endface.

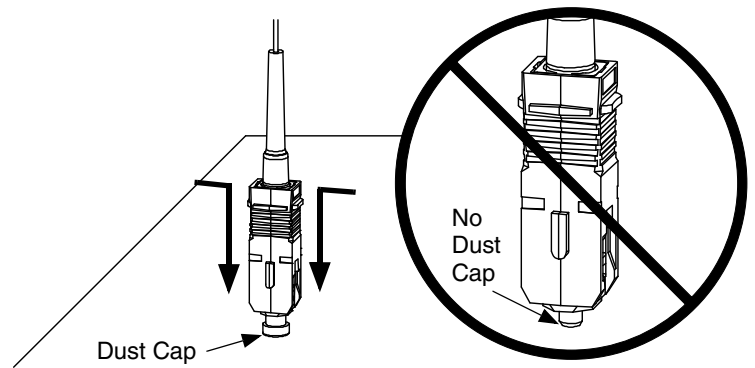

Jacketed Cable Termination

Note: When using OptiCam 2 termination tool, refer to FS132 Quick Setup Guide on how to use tool.

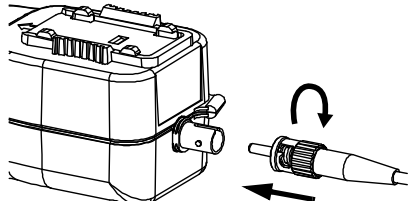
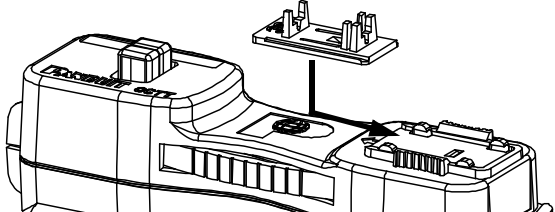
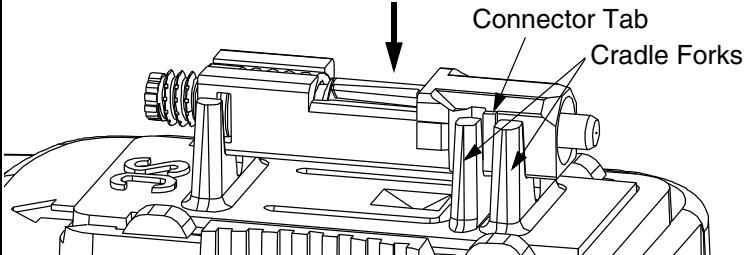
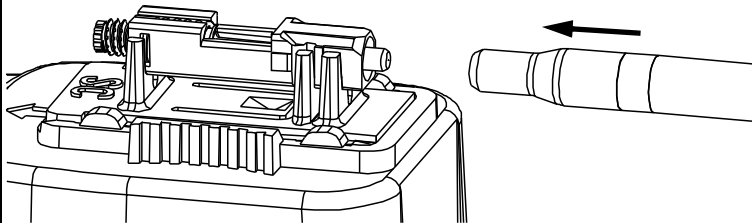
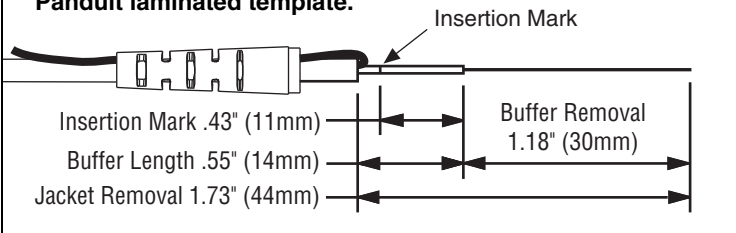
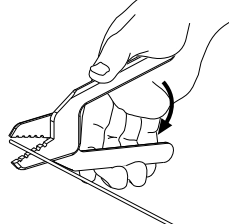
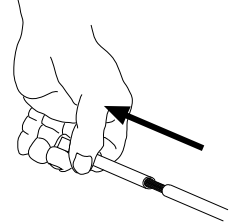
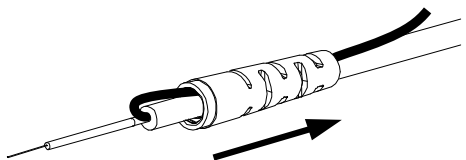
<p>1. Attach Patch Cord to OCTT Make sure laser switch is in the "O" (OFF) position. Remove protective dust cover from laser. Insert ST end of FVFLPC-2.5SMY patch cord into laser aperture making sure to align tabs. Rotate barrel of ST connector clockwise to lock in place.</p>	
<p>2. Insert Connector Cradle Align SC Cradle with OCTT cradle holder and slide cradle under tabs of cradle holder until it stops. Grip cradle holder by grip pads and slide cradle holder to the pre-termination position (towards the laser aperture).</p>	
<p>3. Insert Connector into Cradle Remove both dust caps from the connector inner housing assembly. Place the inner housing assembly into the SC cradle so that the tabs on the connector housing are between the cradle forks.</p>	
<p>4. Attach Patch Cord to Connector Ferrule Note: During insertion, the ferrule adapter end must be in-line with the connector ferrule, NOT at an angle. While holding the connector still, gently slide the ferrule adapter end over the connector ferrule until it stops. To maximize VFL patch cord life, avoid side-loading the ferrule adapter end during insertion and testing.</p>	
<p>5. Strip Jacketed Cable</p> <p>5.1 If using duplex cable, split the two cables approximately 6" (152mm) or as needed.</p> <p>5.2 Following the stripping dimensions, use the marking pen to mark the cable jacket 1.73" (44mm) from the end.</p> <p>5.3 Strip off the cable at the jacket removal mark. To reduce wear on the jacket stripper blades, do not slide the blades along the aramid yarn. Instead, use the tool to cut through the jacket, then pull off the jacket by hand. For 3.0mm jacketed fiber, use the third hole (marked "1.3mm" or #16AWG) from the tip of the jacket stripper. For 1.6mm - 2.0mm jacketed fiber, use the first hole (marked "0.8mm" or #20AWG) from the tip of the jacket stripper.</p> <p>5.4 Insert fiber through the small end of appropriate boot for your specific cable type. Use the boot to fold the aramid yarn back over the jacket, holding it out of the way.</p> <p>5.5 Use the marking pen to place a buffer length mark on the buffer 0.55" (14mm) from the edge of the jacket. Place an insertion mark 0.43" (11mm) back from the first mark.</p> <p>5.6 Use the marking pen to place a mark on the buffer at the edge of the jacketing.</p> <p>5.7 Use the buffer stripper to strip the buffer to the buffer length mark.</p>	<p>Jacketed Cable STRIPPING DIMENSIONS IMPORTANT! Due to printing variations, use a rigid scale for stripping dimensions, or the appropriate Panduit laminated template.</p>    

(Step 5 cont'd)**Buffer Stripping Guidelines**

- Remove no more than 1/4" (6mm) of buffer at a time to avoid breaking the fiber. Refer to cable manufacturer's buffer stripping guidelines for specific recommendations.
- Hold the buffer stripper such that the arrow on the tool points in the direction of buffer removal.
- Position the fiber in the tool's V-notches. Squeeze the handles firmly and pull tool in the direction of the arrow on the tool.
- Clean the buffer stripper blades after each strip by holding the handles open then pulling the casings back and letting them snap back against the blades.

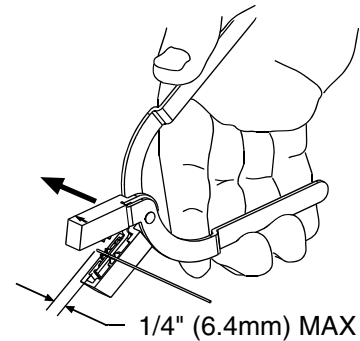
**6. Cleave 900µm Tight-Buffered Fiber**

- 6.1 Remove and dispose of any remaining fiber scraps in the cleaving tool.
- 6.2 Clean bare fiber using an isopropyl alcohol (90% minimum concentration) soaked lint-free wipe. The fiber should be free of all coating and residue. To prevent contamination, do not set fiber down or allow it to touch anything after cleaning.
- 6.3 Depress the fiber clamp lever and insert the end of the fiber under the fiber clamp and in the V-groove. Hold the cleaving tool in your hand and depress the fiber clamp lever to raise the fiber clamp. Insert the end of the fiber into the V-groove and under the fiber clamp. Release the fiber clamp lever when the end of the buffer is located at the 7mm mark (± 0.5 mm).
- 6.4 **This is a critical step for successful termination.** Gently hold the buffered fiber against the groove in the base plate using thumb and forefinger of your free hand. With your other thumb, **gently** push down on the housing until the ceramic blade contacts the fiber and the end of the housing contacts the rubber coating on the base plate. **DO NOT** cut the fiber with the ceramic blade. Release the housing so that the blade is no longer contacting the fiber.
- 6.5 Hold the tool in one hand while still holding the fiber against the base plate. Bend the base plate down until the fiber breaks. To prevent contamination, do not set fiber down or allow it to touch anything after cleaving. **IMPORTANT:** Do not clean fiber after cleaving. Replace the ceramic blade in the cleaving tool after every 1000 cleaves, or if installation yield decreases.
- 6.6 Replacement blade (FJQCVRB) is available.

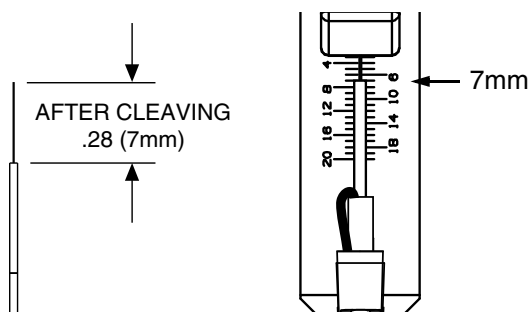
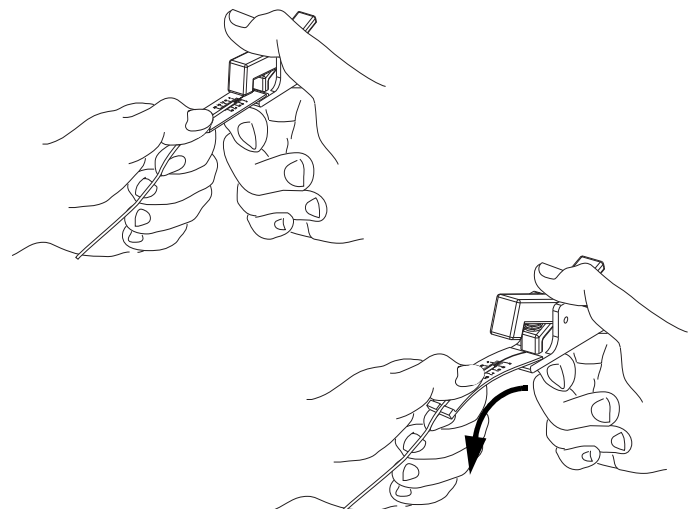
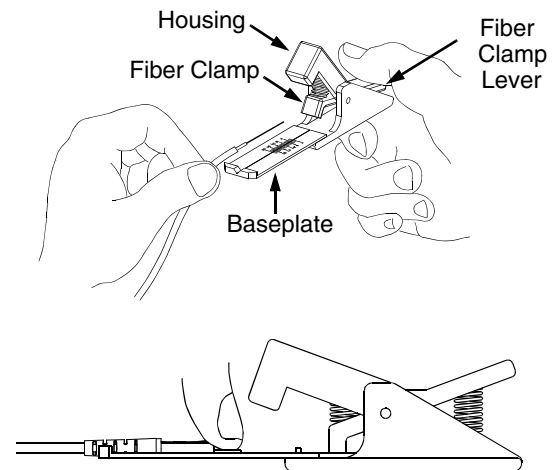
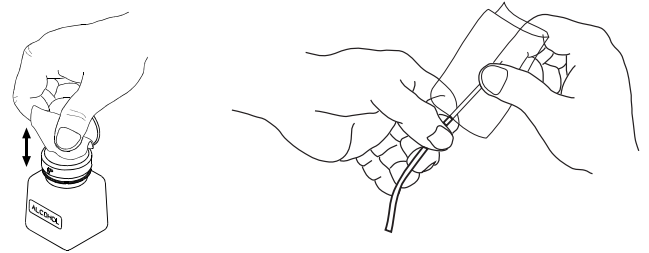

7. Insert Fiber

- 7.1 Check the location of the buffer length mark to make sure it is at the edge of the jacket. If necessary, carefully work the fiber back in until the mark is at the edge of the jacket.
- 7.2 Insert fiber into the connector body using constant light pressure until it stops on the fiber stub. Excessive force during insertion may break the fiber. The fiber should be guided in straight not at an angle. If resistance is felt before the fiber insertion mark is in close proximity to the back of the connector then retract the fiber a small amount and continue inserting. If the fiber insertion mark is not in close proximity to the back of the connector then withdraw the fiber completely out of the connector. Inspect fiber cleave length. If the fiber cleave length is less than 7mm then discard the connector and return to step 5. If the fiber cleave length is 7mm then slightly rotate the fiber before repeating this step.

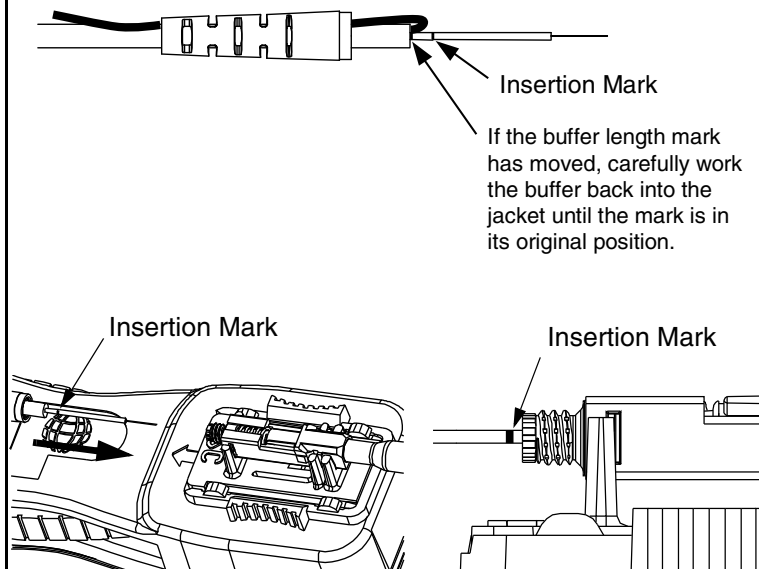

8. Clamp Cable

Squeeze both clamp arms to open clamp pads. Place cable between the clamp pads and release clamp arms. The fiber should be straight and the insertion mark should still be in close proximity to the back of the connector.

Note: Do not shuttle cradle holder for jacketed cable terminations.

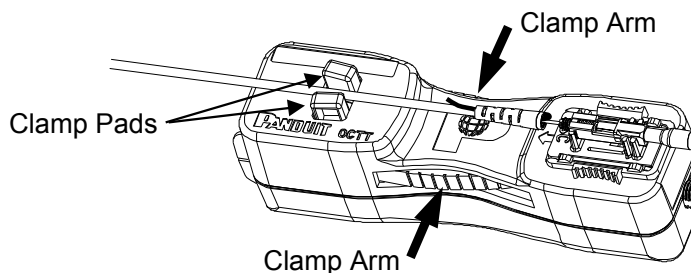

9. Turn On Laser

On the end of the OCTT tool, toggle the switch to the "I" (ON) position. If the fiber is in the correct position after this step, a multimode connector typically will either be dark or glow very dimly; a singlemode connector will typically glow moderately.

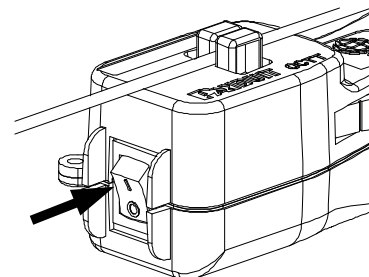

10. Cam the Connector

Rotate the cam lever 90° counterclockwise until it stops (when looking from rear of connector). The glow coming from the connector cam region should dim or remain dark. If not, turn the laser off and un-cam the connector. Pull fiber back slightly and then gently urge it forward until it stops on the stub fiber. (Re-check to make sure the insertion mark is near the back of the connector) Turn the laser on and re-cam the connector, it should dim or remain dark. If not, turn off the laser and repeat the process starting at step 5.

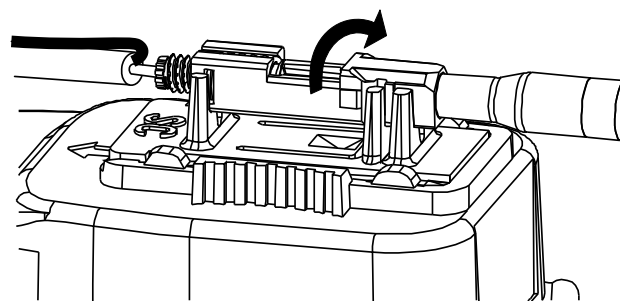

11. Turn Off Laser

Toggle the OCTT switch to the "O" (OFF) position. While holding connector in place, remove ferrule adapter end of patch cord from connector.

12. Place the Dust Cover on the Patch Cord (Optional)

13. Unclamp Cable

Squeeze both clamp arms to open the clamp pads. Remove cable from between the clamp pads and release clamp arms.
CAUTION: DO NOT pull on cable while the connector is still held in place by the cradle. Doing so could break the fiber or create an unacceptable termination.

14. Remove Connector from Cradle

Remove the connector from the cradle by lifting straight up.

15. Remove Fiber from Cleaver Tool

Depress the fiber clamp lever then remove and properly dispose of the fiber scrap.

16. Assemble Connector and Boot

- 16.1 Slide the boot back to release the aramid yarn. Cut the aramid yarn approximately 0.20" (5mm) past the flange.
- 16.2 Flare the aramid yarn **evenly** around the perimeter of the grooved area of the backbone. Use tweezers for best results. There will be a slight gap between the cable jacket and the backbone.
- 16.3 Push the boot forward and thread clockwise onto the grooved area of the backbone until it seats against the flange. Best cable retention is achieved when the aramid yarn protrudes slightly from the flange area.
- 16.4 Align the external chamfers on the front of the inner housing assembly with the internal chamfers at the front of the outer housing.
- 16.5 Push the inner housing assembly into the outer housing until it snaps into place. Once in place the outer housing should be able to move freely back and forth over the inner housing and boot. Clean the ferrule end face with an alcohol soaked wipe, and then a dry wipe. Place dust cap over the ferrule end.

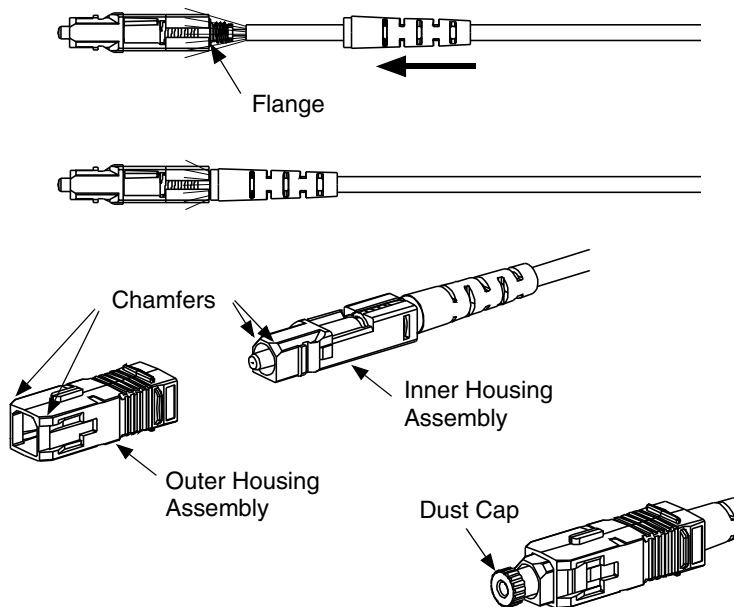

17. Attach Duplex Clip (Optional)

- 17.1 Orient the connector as shown with the connector key facing upward in the same direction as the 'A', 'B' and 'KEY' markings on the duplex clip. Insert the connector into one side of the clip on a slight angle and rotate into place. The upper and lower legs of the clip slide over the connector and "snap" when the connector is in place. The connector is fully seated once the top and bottom connector flanges are inside of the rectangular slots in the clip.
- 17.2 Repeat this procedure for the other connector, completing the duplexing step.

Note: When making cable assemblies, be sure to follow the correct 'A->B' polarity cross-over between connectors.

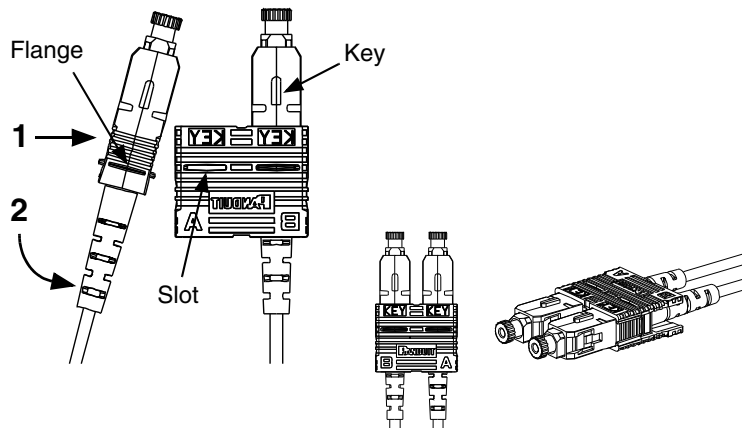

18. Re-Termination

The connector can be re-terminated if needed. Make sure that the dust cap is on the ferrule. Grip the outer housing and push tip of connector down onto a hard surface. The inner housing will release from the outer housing. Remove the outer housing. Unscrew the boot from the backbone. Un-cam the connector and remove the fiber. Repeat from step 1.

CAUTION: DO NOT push down without a dust cap installed on the ferrule. Doing so could damage the pre-polished fiber endface.

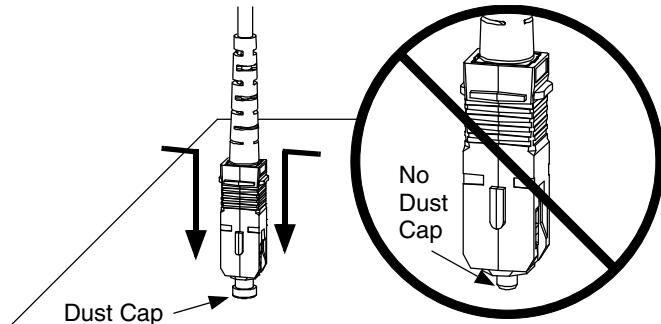

For Instructions in Local Languages and Technical Support:

www.panduit.com/resources/install_maintain.asp



www.panduit.com

E-mail: techsupport@panduit.com

Phone: 866-405-6654