

DATA SHEET

# SMP1334-084LF: 100 W High-Power Silicon PIN Diode

## Applications

- Low-loss, high-power switches
- Low-distortion attenuators

## Features

- High RF power handling: 100 W
- Low thermal resistance: 10 °C/W
- Low series resistance: 0.45 Ω typical @ 100 mA
- Low total capacitance: 0.45 pF maximum @ 30 V
- Small QFN (2 x 2 mm) package (MSL1, 260 °C per JEDEC J-STD-020)



## Description

The SMP1334-084LF is a surface-mountable, low-capacitance silicon PIN diode designed as a series-connected PIN diode for high-power, high-volume switch and attenuator applications from 10 MHz to beyond 6 GHz.

Typical resistance at 100 mA is 0.45 Ω and maximum capacitance at 30 V is 0.45 pF. The combination of low capacitance, low parasitic inductance, and nominal 50 μm I-region width, makes the SMP1334-084LF useful in large signal switches and attenuator applications.

The device has a 1 W dissipation power rating, which makes it capable of handling up to 100 W @ 25 °C Continuous Wave (CW) in a series-connected transmit/receive (T/R) switch.

Design information for high power switches may be found in the Skyworks Application Note, *Design With PIN Diodes* (document number 200312).



Skyworks Green™ products are compliant with all applicable legislation and are halogen-free. For additional information, refer to *Skyworks Definition of Green™*, document number SQ04-0074.

### Electrical and Mechanical Specifications

The absolute maximum ratings of the SMP1334-084LF are provided in Table 1. Electrical specifications are provided in Table 2. Typical DC performance characteristics of the SMP1334-084LF are illustrated in Figures 1, 2, and 3.

The SMP1334-084LF Evaluation Board is used to test the performance of the SMP1334-084LF PIN Diode. Figure 4 shows a

bias schematic, and Table 3 lists the Evaluation Board Bill of Materials. Typical RF performance of the SMP1334-084LF using the schematic shown in Figure 4 is summarized in Table 4 and illustrated in Figures 5, 6, and 7.

An assembly drawing for the Evaluation Board is shown in Figure 8. The layer detail physical characteristics are provided in Figure 9.

**Table 1. SMP1334-084LF Absolute Maximum Ratings<sup>1</sup>**

Parameter	Symbol	Minimum	Maximum	Units
Forward current	I <sub>F</sub>		200	mA
Reverse voltage	V <sub>R</sub>		200	V
Dissipated power @ 85 °C	P <sub>D</sub>		1	W
Peak pulse power dissipation @ 85 °C (10% duty cycle)			10	W
Operating temperature	T <sub>A</sub>	-55	+85	°C
Storage temperature	T <sub>STG</sub>	-55	+200	°C
Junction temperature	T <sub>J</sub>	-55	+175	°C
Electrostatic discharge: Charged-Device Model (CDM), Class 4 Human Body Model (HBM), Class 3A Machine Model (MM), Class C	ESD		1100 5000 400	V V V

<sup>1</sup> Exposure to maximum rating conditions for extended periods may reduce device reliability. There is no damage to device with only one parameter set at the limit and all other parameters set at or below their nominal value. Exceeding any of the limits listed here may result in permanent damage to the device.

**ESD HANDLING:** Although this device is designed to be as robust as possible, electrostatic discharge (ESD) can damage this device. This device must be protected at all times from ESD when handling or transporting. Static charges may easily produce potentials of several kilovolts on the human body or equipment, which can discharge without detection. Industry-standard ESD handling precautions should be used at all times.

**Table 2. SMP1334-084LF Electrical Specifications<sup>1</sup>**  
(T<sub>A</sub> = +25 °C, Unless Otherwise Noted)

Parameter	Symbol	Test Condition	Min	Typ	Max	Units
Forward voltage	V <sub>F</sub>	I <sub>F</sub> = 10 mA		0.75		V
Reverse leakage current	I <sub>R</sub>	V <sub>R</sub> = 200 V			10	μA
Series resistance	R <sub>s1</sub>	I <sub>F</sub> = 1 mA, f = 100 MHz		16.5	20	Ω
	R <sub>s10</sub>	I <sub>F</sub> = 10 mA, f = 100 MHz		2.0	2.5	Ω
	R <sub>s100</sub>	I <sub>F</sub> = 100 mA, f = 100 MHz		0.45		Ω
Total capacitance	C <sub>t30</sub>	V <sub>R</sub> = 30 V, f = 1 MHz		0.40	0.45	pF
Series inductance	L <sub>s</sub>			0.37		nH
Minority carrier lifetime	T <sub>L</sub>	I <sub>F</sub> = 10 mA		700		ns
I region width	W			50		μm
Thermal resistance (Note 2)	Θ <sub>JC</sub>	Junction-to-case		10		°C/W
Peak thermal resistance	Θ <sub>P</sub>	Single, 1 μs pulse width, junction-to-case (10% duty cycle)		1		°C/W

<sup>1</sup> Performance is guaranteed only under the conditions listed in this table.

<sup>2</sup> Assume a thermal resistance of 90 °C/W for the junction-to-bottom of the circuit board.

**Typical DC Performance Characteristics**  
( $T_A = 25\text{ }^\circ\text{C}$ , Unless Otherwise Noted)

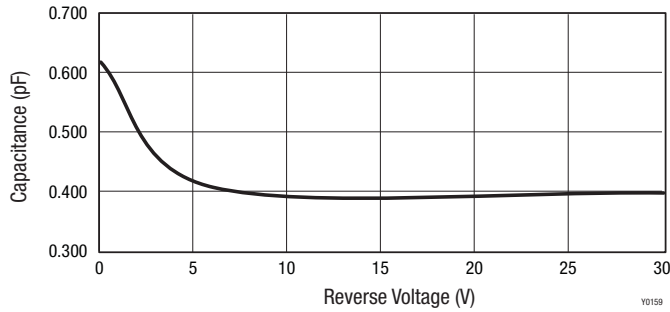

**Figure 1. Capacitance vs Reverse Voltage @ 1 MHz**

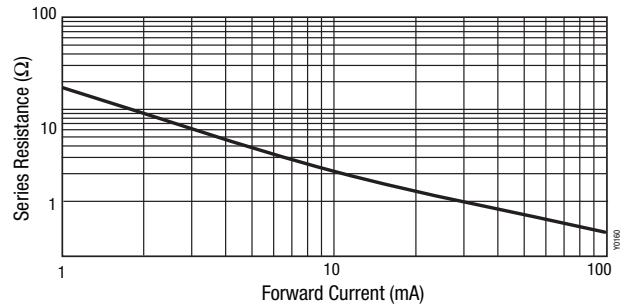

**Figure 2. Series Resistance vs Forward Current @ 100 MHz**

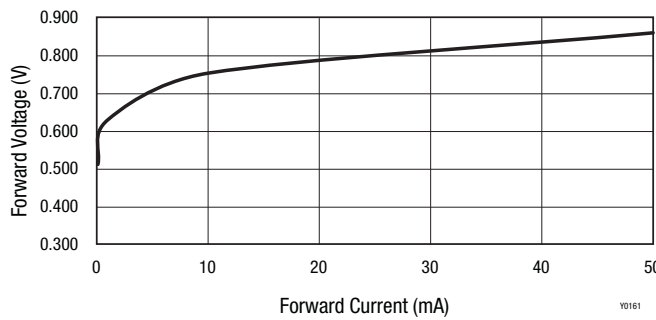

**Figure 3. Forward Voltage vs Forward Current**

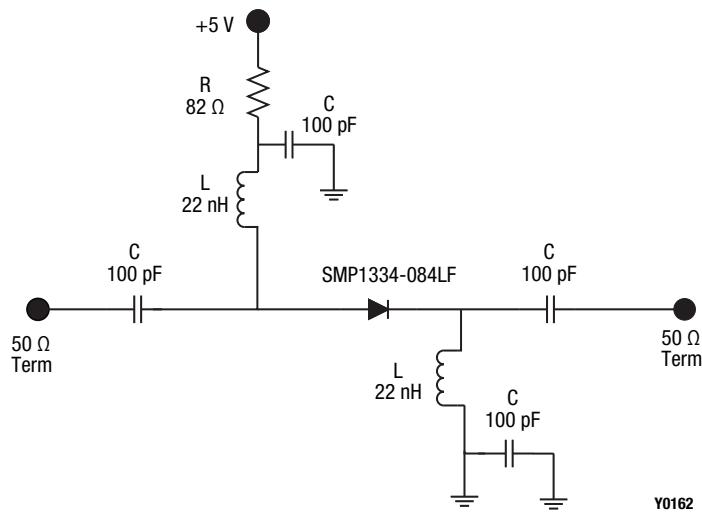

**Figure 4. SMP1334-084LF Bias Schematic**

**Table 3. Evaluation Board Bill of Materials for EN33-D515-01\_V3 (Tuned Circuit)**

Component	Value	Size	QTY	Manufacturer	Mfg. Part Number	Characteristics
C	100 pF	0402	4	Murata	GRM1555C1H101JZ01	5% COG 50 V
L	22 nH	0402	2	Murata	HK100522NJ-T	5%
R	82 $\Omega$	0402	1	Panasonic	ERJ2GEJ820X	5%, 0.1 W

**Table 4. Typical RF Performance @ 25 °C, f = 2.6 GHz**

Parameter	Typical	Units
<b>Un-tuned</b>		
Insertion loss	0.22	dB
Return loss	15	dB
Isolation	-6.4	dB
<b>With 22 nH Bias Circuit</b>		
Insertion loss	0.5	dB
Return loss	11.7	dB
Isolation	-8.2	dB
Max power	+50	dBm

**Typical RF Performance Characteristics**

(TOP = +25 °C, Characteristic Impedance [Z0] = 50 Ω, EVB Optimized with Bias Circuit, Unless Otherwise Noted)

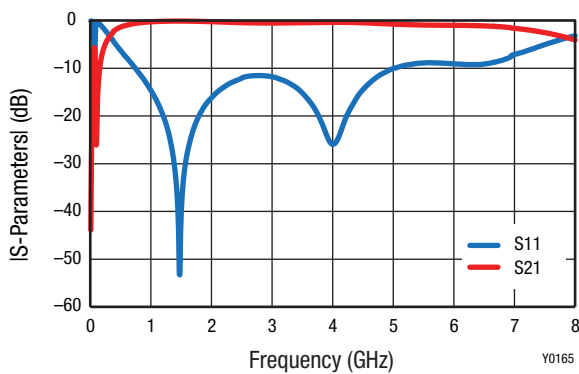

**Figure 5. S-Parameter Magnitude vs Frequency If = 50 mA**

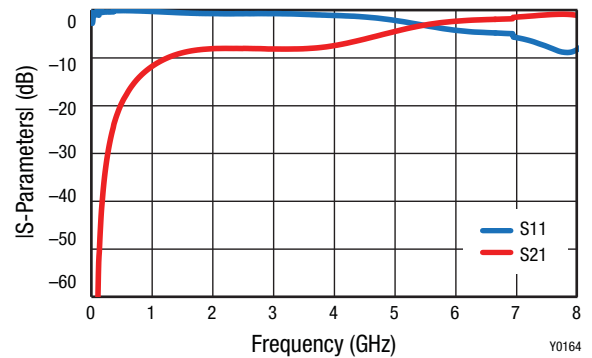

**Figure 6. S-Parameter Magnitude vs Frequency VREV = -30 V**

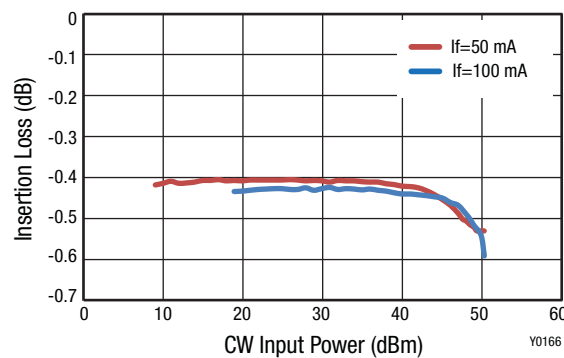

**Figure 7. Insertion Loss vs CW Input Power f=2.6 GHz**

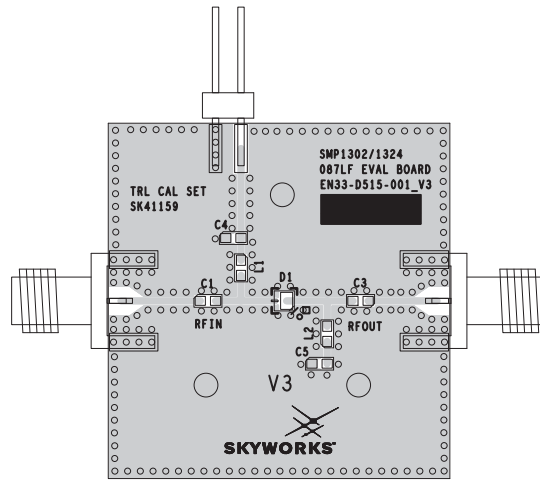

Figure 8. SMP1334-084LF Evaluation Board

Cross Section	Name	Thickness (in)	Material
	Top Soldermask		
	L1	(0.0028)	Cu foil
	Laminate	0.012 ± 0.0006	Rogers R04003C Core
	L2	(0.0014)	Cu foil
	Laminate	(Note 1)	FR4 Prepreg
	L3	(0.0014)	Cu foil
	Laminate	0.010 ± 0.0006	FR4 Core
	L4	(0.0028)	Cu foil
	Bottom Soldermask		

Note 1: Adjust this thickness to meet total thickness goal of 0.062 ± 0.005 inches.

S2531

Figure 9. Board Layer Detail Physical Characteristics

### Package Dimensions

The PCB layout footprint for the SMP1334-084LF is provided in Figure 10. Typical part markings are shown in Figure 11. Package dimensions for the SMP1334-084LF are provided in Figure 12, and tape and reel dimensions are provided in Figure 13.

### Package and Handling Information

Instructions on the shipping container label regarding exposure to moisture after the container seal is broken must be followed.

Otherwise, problems related to moisture absorption may occur when the part is subjected to high temperature during solder assembly.

The SMP1334-084LF is rated to Moisture Sensitivity Level 1 (MSL1) at 260 °C. It can be used for lead or lead-free soldering. For additional information, refer to the Skyworks Application Note, *Solder Reflow Information*, document number 200164.

Care must be taken when attaching this product, whether it is done manually or in a production solder reflow environment. Production quantities of this product are shipped in a standard tape and reel format.

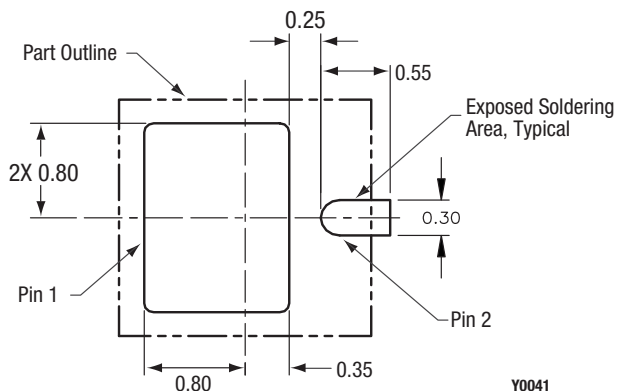

**Figure 10. SMP1334-084LF PCB Layout Footprint (Top View)**

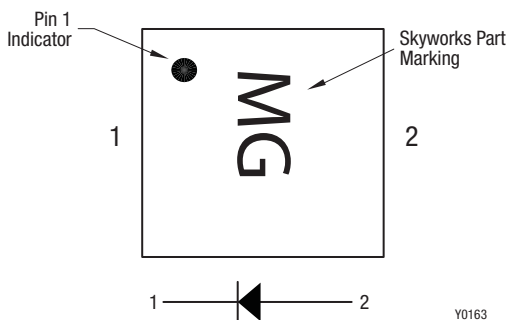

**Figure 11. Typical Part Markings (Top View)**



## Ordering Information

Model Name	Manufacturing Part Number	Evaluation Board Part Number
SMP1334-084LF: 100 W High-Power Silicon PIN Diode	SMP1334-084LF	SMP1334-084LF EVB

Copyright © 2013, 2015, 2017 Skyworks Solutions, Inc. All Rights Reserved.

Information in this document is provided in connection with Skyworks Solutions, Inc. (“Skyworks”) products or services. These materials, including the information contained herein, are provided by Skyworks as a service to its customers and may be used for informational purposes only by the customer. Skyworks assumes no responsibility for errors or omissions in these materials or the information contained herein. Skyworks may change its documentation, products, services, specifications or product descriptions at any time, without notice. Skyworks makes no commitment to update the materials or information and shall have no responsibility whatsoever for conflicts, incompatibilities, or other difficulties arising from any future changes.

No license, whether express, implied, by estoppel or otherwise, is granted to any intellectual property rights by this document. Skyworks assumes no liability for any materials, products or information provided hereunder, including the sale, distribution, reproduction or use of Skyworks products, information or materials, except as may be provided in Skyworks Terms and Conditions of Sale.

THE MATERIALS, PRODUCTS AND INFORMATION ARE PROVIDED “AS IS” WITHOUT WARRANTY OF ANY KIND, WHETHER EXPRESS, IMPLIED, STATUTORY, OR OTHERWISE, INCLUDING FITNESS FOR A PARTICULAR PURPOSE OR USE, MERCHANTABILITY, PERFORMANCE, QUALITY OR NON-INFRINGEMENT OF ANY INTELLECTUAL PROPERTY RIGHT; ALL SUCH WARRANTIES ARE HEREBY EXPRESSLY DISCLAIMED. SKYWORKS DOES NOT WARRANT THE ACCURACY OR COMPLETENESS OF THE INFORMATION, TEXT, GRAPHICS OR OTHER ITEMS CONTAINED WITHIN THESE MATERIALS. SKYWORKS SHALL NOT BE LIABLE FOR ANY DAMAGES, INCLUDING BUT NOT LIMITED TO ANY SPECIAL, INDIRECT, INCIDENTAL, STATUTORY, OR CONSEQUENTIAL DAMAGES, INCLUDING WITHOUT LIMITATION, LOST REVENUES OR LOST PROFITS THAT MAY RESULT FROM THE USE OF THE MATERIALS OR INFORMATION, WHETHER OR NOT THE RECIPIENT OF MATERIALS HAS BEEN ADVISED OF THE POSSIBILITY OF SUCH DAMAGE.

Skyworks products are not intended for use in medical, lifesaving or life-sustaining applications, or other equipment in which the failure of the Skyworks products could lead to personal injury, death, physical or environmental damage. Skyworks customers using or selling Skyworks products for use in such applications do so at their own risk and agree to fully indemnify Skyworks for any damages resulting from such improper use or sale.

Customers are responsible for their products and applications using Skyworks products, which may deviate from published specifications as a result of design defects, errors, or operation of products outside of published parameters or design specifications. Customers should include design and operating safeguards to minimize these and other risks. Skyworks assumes no liability for applications assistance, customer product design, or damage to any equipment resulting from the use of Skyworks products outside of stated published specifications or parameters.

Skyworks and the Skyworks symbol are trademarks or registered trademarks of Skyworks Solutions, Inc., in the United States and other countries. Third-party brands and names are for identification purposes only, and are the property of their respective owners. Additional information, including relevant terms and conditions, posted at [www.skyworksinc.com](http://www.skyworksinc.com), are incorporated by reference.